



ARIB STD-T109

ENGLISH TRANSLATION

700 MHz BAND
INTELLIGENT TRANSPORT SYSTEMS

ARIB STANDARD

ARIB STD-T109 Version 1.1

Version 1.0 February 14th 2012

Version 1.1 December 18th 2012

Association of Radio Industries and Businesses

General Notes to the English translation of ARIB Standards and Technical Reports

1. The copyright of this document is ascribed to the Association of Radio Industries and Businesses (ARIB).
2. All rights reserved. No part of this document may be reproduced, stored in a retrieval system, or transmitted, in any form or by any means, without the prior written permission of ARIB.
3. The ARIB Standards and ARIB Technical Reports are usually written in Japanese and resolved by the ARIB Standard Assembly. This document is a translation into English of the resolved document for the purpose of convenience of users. If there are any discrepancies in the content, expressions, etc., between the Japanese original and this translated document, the Japanese original shall prevail.
4. The establishment, revision and abolishment of ARIB Standards and Technical Reports are resolved at the ARIB Standard Assembly, which meets several times a year. Adopted ARIB Standards and Technical Reports, in their original language, are made publicly available in hard copy, CDs or through web posting, generally in about one month after the date of approval. The original document of this translation may have been further revised and therefore users are encouraged to check the latest version at an appropriate page under the following

URL:

<http://www.arib.or.jp/english/index.html>

Introduction

The Association of Radio Industries and Businesses (ARIB) has been investigating and summarizing the basic technical requirements for establishing standards. These will appear in the form of standards and specifications governing the use of radio transmission facilities and equipment. The standards are being developed based on the participation of and discussions with, radio equipment manufacturers, telecommunication operators, broadcasting equipment manufacturers, broadcasting operators, users and others.

The standards and specifications contained herein will serve as guidelines for developing standards for private use based on the publicly established technical standards in Japan. Their purpose is to enable effective use of radio frequencies by avoiding interference among users, conflicts among the standards of individual operators, and so forth, so that all parties involved, including radio equipment manufacturers, telecommunication operators, broadcasting equipment manufacturers, broadcasting operators, users and others will be able to ensure the quality and compatibility of radio facilities and equipment.

These standards are being established principally for "700 MHz BAND INTELLIGENT TRANSPORT SYSTEMS". In order to ensure fairness and openness among all parties involved, during drafting stages, we invite radio equipment manufacturers, telecommunication operators, broadcasting equipment manufacturers, broadcasting operators, users and others both domestically and overseas to participate openly in the activities of the Standard Assembly so as to develop standards with the total agreement of all parties involved.

We hope that the standards will aid all parties involved, including radio equipment manufacturers, telecommunication operators, broadcasting equipment manufacturers, broadcasting operators, users and others in the development of an excellent radio telecommunication system.

NOTE: Although this ARIB Standard contains no specific reference to any Essential Industrial Property Rights relating thereto, the holders of such Essential Industrial Property Rights state to the effect that the rights listed in the List of Essential Industrial Property Rights, which are the Industrial Property Rights relating to this

standard, are held by the parties also listed therein, and that to the users of this standard, in the case of selection of Option 1, such holders shall not assert any rights and shall unconditionally grant a license to practice such Industrial Property Rights contained therein, and in the case of selection of Option 2, the holders shall grant, under reasonable terms and conditions, a non-exclusive and non-discriminatory license to practice the Industrial Property Rights contained therein. However, this does not apply to anyone who uses this ARIB Standard and also owns and lays claim to any other Essential Industrial Property Rights covered in whole or part in the contents of the provisions of this ARIB Standard.

List of Essential Industrial Property Rights (selection of Option 2)

PATENT HOLDER	NAME OF PATENT	REGISTRATION NO. /APPLICATION NO.	REMARKS
DENSO CORPORATION	WIRELESS COMMUNICATION SYSTEM AND APPARATUS	Publication No. 2010-21870	
DENSO CORPORATION	WIRELESS COMMUNICATION APPARATUS AND SYSTEM	Publication No. 2011-234399	
DENSO CORPORATION	WIRELESS COMMUNICATION APPARATUS AND SYSTEM	Publication No. 2011-234400	
DENSO CORPORATION	WIRELESS COMMUNICATION APPARATUS AND SYSTEM	Publication No. 2011-199910	
DENSO CORPORATION	WIRELESS COMMUNICATION APPARATUS AND SYSTEM	Publication No. 2011-205697	
DENSO CORPORATION	WIRELESS COMMUNICATION APPARATUS AND SYSTEM	Publication No. 2011-234401	
DENSO CORPORATION	WIRELESS COMMUNICATION APPARATUS	Publication No. 2011-55113	
Sumitomo Electric Industries, Ltd.	Wireless communication system and methods for adjusting the time in the system	Publication No. 2011-199689	
Sumitomo Electric Industries, Ltd.	Wireless communication system and methods for adjusting the time in the system	Application No. 2012-187822	

Contents

Introduction	
Chapter 1 General Descriptions	1
1.1 Overview	1
1.2 Scope of application	1
1.3 Scope of standardization	2
1.4 Normative references	3
Chapter 2 General System Overview	5
2.1 System configuration.....	5
2.1.1 Base station.....	5
2.1.2 Mobile station.....	5
2.2 Interface definition	5
2.3 Basic functions of the system.....	6
2.3.1 Requirements of the system	6
2.3.2 Services provided by this system	6
2.4 Radio communication method.....	7
2.4.1 Transmission method.....	7
2.4.2 Access method	7
2.5 Protocol.....	8
2.5.1 Protocol stack	8
2.5.1.1 Features of Layer 1	8
2.5.1.2 Features of Layer 2	8
2.5.1.3 Features of Inter-Vehicle and Roadside-to-Vehicle Communication Layer.....	9
2.5.1.4 Features of Layer 7	9
2.5.1.5 Internet protocol.....	9
2.5.2 Numbering plan (Addressing)	9
2.6 Security method.....	9
Chapter 3 General Requirements and Technical Requirements for Radio Equipment	11
3.1 General requirements	11
3.1.1 Communication method.....	11
3.1.2 Content of communication.....	11
3.1.3 Operating frequency band.....	11
3.1.4 Security measures.....	11
3.2 Technical requirements for radio equipment	11

3.2.1 Transmitter	11
3.2.1.1 Antenna power.....	11
3.2.1.2 Antenna power tolerance	11
3.2.1.3 Frequency tolerance	12
3.2.1.4 Modulation.....	12
3.2.1.5 Occupied bandwidth.....	12
3.2.1.6 Transmission data rate	12
3.2.1.7 Permissible values for unwanted emission intensity	12
3.2.1.8 Modulation accuracy	13
3.2.2 Receiver	13
3.2.2.1 Limits of incidentally produced radiation.....	13
3.2.2.2 Reception sensitivity	14
3.2.2.3 Maximum input power for reception.....	14
3.2.2.4 Blocking characteristics	14
3.2.3 Controller	14
3.2.3.1 Interference prevention function.....	14
3.2.3.2 Carrier sense function.....	15
3.2.3.3 Transmission time control function.....	15
3.2.4 Antenna	15
3.2.4.1 Antenna structure	15
3.2.4.2 Antenna polarization.....	15
3.2.4.3 Antenna gain.....	15
3.2.4.4 Antenna installation.....	16
3.2.5 Other.....	16
3.2.5.1 Cabinet.....	16
3.2.5.2 Mark in relation to technical regulations conformity certification.....	16
3.3 Connection to telecommunication circuit	16
3.3.1 Identification code.....	16
3.3.2 Detection of the availability of the operating frequency band	16
3.3.3 Mark in relation to technical requirements compliance approval for terminal equipment.....	17
Chapter 4 Communication Control System	19
4.1 Overview	19
4.1.1 Overview of relationship between layers, layer management and system management.....	19

4.2 Layer 1 (Physical Layer) standards.....	21
4.2.1 Overview.....	21
4.2.2 Interface service specification of Physical Layer	21
4.2.2.1 Specification of service	21
4.2.2.2 Service parameters.....	22
4.2.3 Physical Layer Convergence Protocol (PLCP) sublayer.....	23
4.2.3.1 Frame format.....	23
4.2.3.2 Preamble	23
4.2.3.3 Signal field.....	23
4.2.3.4 Data field	23
4.2.3.5 Detection of the operating channel (clear channel assessment)	23
4.2.3.6 Data modulation and modulation rate change	23
4.2.3.7 General specification of PMD sublayer	23
4.2.3.8 PMD transmitter specifications.....	24
4.2.3.9 PMD receiver specifications.....	25
4.2.3.10 Transmit PLCP.....	25
4.2.3.11 Receive PLCP.....	25
4.2.4 Physical Layer Management Entity	25
4.2.4.1 Management primitives	25
4.2.4.2 PHY MIB.....	26
4.2.4.3 TXTIME calculation	26
4.2.4.4 PHY characteristics.....	26
4.2.5 PMD sublayer.....	26
4.2.5.1 Scope and field of application	26
4.2.5.2 Overview of service.....	26
4.2.5.3 Overview of interactions	27
4.2.5.4 Basic service and options	27
4.2.5.5 Detailed service specification.....	27
4.3 Layer 2 (Data Link Layer) standards.....	28
4.3.1 Overview.....	28
4.3.2 Protocol data unit.....	28
4.3.2.1 MAC Control field.....	28
4.3.2.2 LLC Control field.....	30
4.3.2.3 FCS field	30
4.3.2.4 Bit order.....	30

4.3.3 Link address (MAC address)	30
4.3.4 Medium access control (MAC) sublayer	31
4.3.4.1 Overview	31
4.3.4.2 Specification of interface service of MAC sublayer	32
4.3.4.3 Function of MAC sublayer	34
4.3.4.4 Access control.....	36
4.3.4.5 Data transmission/reception control	38
4.3.5 Logical Link Control sublayer (LLC sublayer).....	43
4.3.5.1 Overview	43
4.3.5.2 LLC sublayer interface service specifications.....	43
4.3.5.3 LLC Protocol Data Unit (PDU).....	45
4.3.5.4 LLC types of procedures.....	46
4.3.5.5 LLC elements of procedure	46
4.3.5.6 LLC procedures	46
4.3.6 Layer 2 layer management service interface	48
4.3.6.1 Overview of interactions between primitives	48
4.3.6.2 Specification of service	49
4.4 Inter-vehicle Communication and Roadside-to-vehicle Communication Control Layer (IVC-RVC Layer) standards.....	51
4.4.1 Overview.....	51
4.4.1.1 General.....	51
4.4.1.2 Functions	52
4.4.2 IVC-RVC Layer interface service specifications.....	53
4.4.2.1 IVC-RVC data service interface.....	53
4.4.2.2 IVC-RVC Layer management service interface.....	54
4.4.3 Inter-vehicle Communication and Roadside-to-vehicle Communication Control ...	57
4.4.3.1 IVC-RVC Protocol Data Unit (PDU).....	57
4.4.3.2 IVC-RVC elements of procedure	61
4.4.3.3 IVC-RVC procedures	63
4.5 Layer 7 standards.....	69
4.5.1 Scope	69
4.5.1.1 Structure	69
4.5.2 Layer 7 service interface.....	70
4.5.2.1 Layer 7 data service interface.....	70
4.5.2.2 Layer 7 management service interface specification.....	80

4.5.3 Layer 7 communication control	83
4.5.3.1 Layer 7 Protocol Data Unit (PDU)	83
4.5.3.2 Layer 7 procedure.....	85
4.6 System Management	89
Chapter 5 Measurement Methods.....	91
5.1 Transmitter	91
5.1.1 Frequency tolerance.....	91
5.1.2 Occupied bandwidth	91
5.1.3 Antenna power tolerance	91
5.1.4 Permissible values for unwanted emission intensity.....	91
5.1.5 Transmission data rate.....	91
5.1.6 Modulation accuracy	92
5.2 Receiver.....	92
5.2.1 Limit on secondary radiated emissions, etc.....	92
5.2.2 Reception sensitivity.....	92
5.2.2.1 Packet error rate measurement.....	93
5.2.3 Maximum input power for reception	93
5.2.4 Blocking characteristics.....	94
5.3 Controller	94
5.3.1 Interference prevention Function (mobile station)	94
5.3.2 Carrier Sense Function (mobile station).....	95
5.3.3 Transmission time control function	95
Chapter 6 Definitions and Abbreviations	97
6.1 Glossary.....	97
6.2 Abbreviations	99
Annex 1 Protocol parameters	103
1 Layer 1	103
1.1 Management information base (MIB).....	103
2 Layer 2	103
2.1 Management information base (MIB).....	103
3 Inter-vehicle Communication and Roadside-to-vehicle Communication Control Layer (IVC-RVC Layer)	104
3.1 Management Information Base (MIB).....	104
Annex 2 Application data structure definitions	107
1 Application Data of a Mobile Station.....	107

2 Application Data of a Base Station.....	108
Description 1 Estimation of transmittable packets in a roadside-to-vehicle transmission period.....	111
1 Overview	111
2 Calculation of time for transmitting one packet.....	111
3 Calculation of time for transmitting plural packets consecutively.....	112
Description 2 An example of the method for synchronizing plural base stations.....	115
1 Overview	115
2 Synchronization of plural base stations	115
2.1 Synchronization with 1PPS signals from GPS receivers (GPS synchronization).....	115
2.2 Synchronization by receiving packets from other base stations (Over-the-air synchronization).....	117
3 Monitoring the synchronization status of other base stations and choosing the method of synchronization	118
3.1 Monitoring target and synchronization target.....	118
3.2 Procedure of monitoring and synchronizing.....	119

Chapter 1 General Descriptions

1.1 Overview

This ARIB STANDARD (hereinafter referred to as “this standard”) specifies an interface between wireless sections of the “Radio Equipment of 700 MHz BAND INTELLIGENT TRANSPORT SYSTEMS” stipulated in the Ministry of Internal Affairs and Communications Ordinance Regulating Radio Equipment, Article 49-22-2, namely, among land mobile stations (hereinafter referred to as “mobile stations”) and between mobile stations and base stations.

1.2 Scope of application

The 700 MHz BAND INTELLIGENT TRANSPORT SYSTEMS (hereinafter referred to as “this system”) is expected to provide drivers on the roads with highly reliable safety information by traffic management operators via roadside-to-vehicle communications, as well as to exchange safety information among nearby vehicles with lower latency, through direct inter-vehicle communications.

This system is to be operated in the 700 MHz radio frequency band, and is comprised with base stations deployed along the roads and mobile stations installed on vehicles, where these stations exchange safety related information generated by applications operating in the system. The primary purpose of this system is to reduce the number of traffic accidents by informing drivers of traffic conditions as well as assisting drivers to recognize nearby vehicles and pedestrians. The system is also expected to smooth out the flow of traffic as a result of such information dissemination.

This standard specifies the radio communication interfaces shown in Figure 1-1.

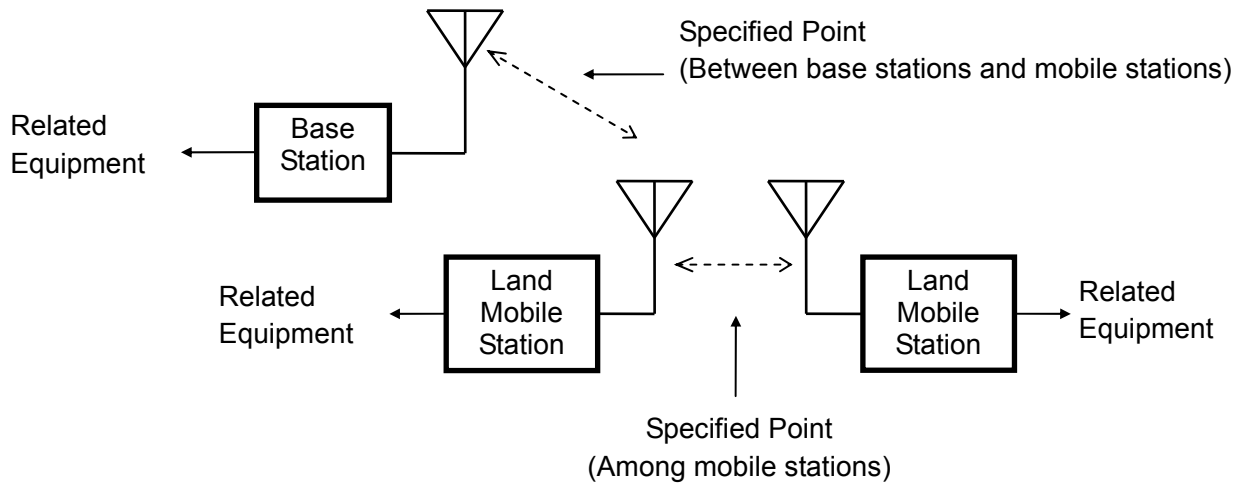

Figure 1-1 Configuration of the system

Note that this standard limits its scope to broadcast communications by base stations and mobile stations, as the system was originally designed to provide a means for safety applications.

Support of unicast and multicast communications for non-safety applications is to be discussed as an extension to this system, and is outside the scope of this version.

1.3 Scope of standardization

Figure 1-2 shows the scope of this standard. The standard is based on the Open Systems Interconnection (OSI) reference model, and specifies the following four layers: Layers 1, Layer 2 and Layer 7, and Inter-Vehicle and Roadside-to-Vehicle Communication (IVC-RVC) Layer. Note that necessary system functions typically specified at Layers 3, Layer 4, Layer 5 and Layer 6 of the OSI reference model are specified at the IVC-RVC Layer and Layer 7, in order to provide highly responsive low latency broadcast communications.

Also, the “Annex” attached to this standard specifies details not included in the main body, which are to be treated as part of the standard. “Descriptions,” on the other hand, provides supplemental information, which is not to be treated as part of the standard.

In this document, variables and information fields marked as “Reserved” are for future extensions of the current standard. Furthermore, any values marked as “default” are not guaranteed to remain “Default” values in future versions of this document.

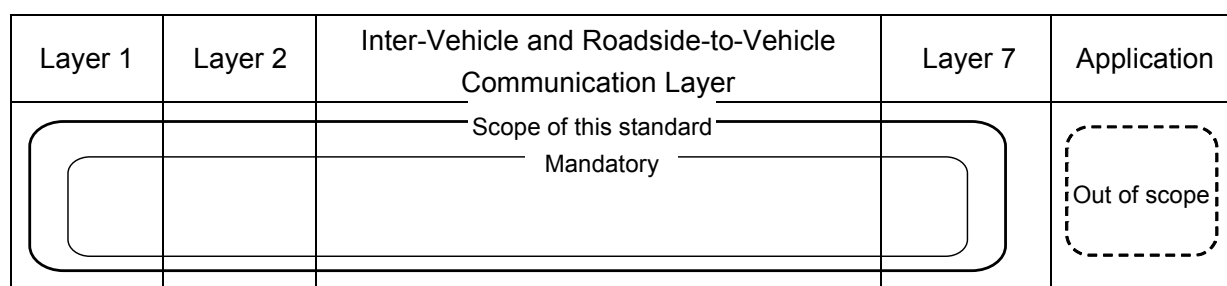

Figure 1-2 Scope of standardization

1.4 Normative references

The terms used in this standard follow the definitions specified in the Japan Radio Act and other related ministerial ordinances unless otherwise noted.

In this standard, "RERL" refers to Regulations for Enforcement of the Radio Law, "ORE" refers to Ordinance Regulating Radio Equipment, "OTRCC" refers to Ordinance Concerning Technical Regulations Conformity Certification etc. of Specified Radio Equipment, "OTF" refers to Ordinance Concerning Terminal Facilities etc., "RTCCA" refers to Rules Concerning the Technical Requirements Compliance Approval etc. for Terminal Equipment, "NT" refers to a Notification of the Ministry of Posts and Telecommunications if issued in 2000 or earlier, and a Notification of the Ministry of Internal Affairs and Communications if issued in 2001 or later.

Furthermore, this standard refers to the following documents on an "as necessary" basis, and uses the corresponding reference numbers:

- [1] IEEE 802.11-2007 IEEE Standard for Information technology—Telecommunications and information exchange between systems—Local and metropolitan area networks— Specific requirements Part 11: Wireless LAN Medium Access Control (MAC) and Physical Layer (PHY) Specifications
- [2] ISO/IEC 8802-2:1998 Information technology -- Telecommunications and information exchange between systems -- Local and metropolitan area networks -- Specific requirements -- Part 2: Logical link control
- [3] IEEE 802-2001 IEEE Standard for Local and Metropolitan Area Networks: Overview and Architecture

NOTE: For the sake of readers who are familiar with IEEE 802.11 standards, this document uses terms consistent with those used in Document [1]-[3]. Please note, however, that

other than the physical layer and the logical link control sublayer, the system architecture specified in this document is different from that of IEEE 802.11.

Chapter 2 General System Overview

2.1 System configuration

This system is configured using a road side base station and a vehicle-installed mobile station.

2.1.1 Base station

The base station performs land mobile radio communication with mobile stations. The radio equipment of the base station is composed of a transmitter, receiver, controller, antenna, etc.

2.1.2 Mobile station

The mobile station performs land mobile radio communication with a base station or other mobile stations. The radio equipment of the base station is composed of a transmitter, receiver, controller, antenna, etc.

2.2 Interface definition

In the system, reference points for the interfaces are as shown in Figure 2-1.

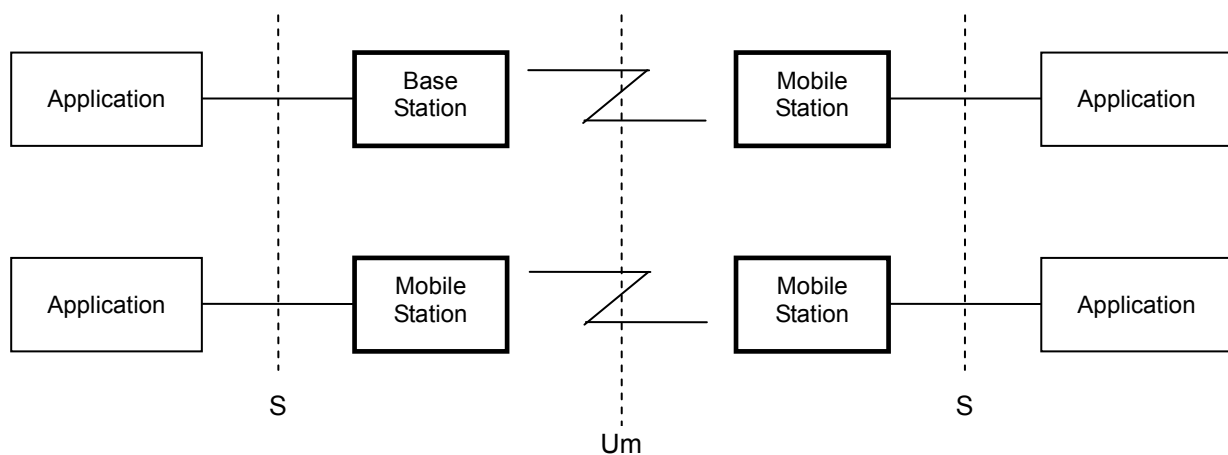

Point Um: Interface point between base station and mobile station as well as among mobile stations ••• Scope of standard

Point S: Interface point between base station and application as well as between mobile station and application ••• Outside the scope

Figure 2-1 Reference points for the interfaces

2.3 Basic functions of the system

This system provides communication means between base stations and mobile stations (Roadside-to-Vehicle Communications) as well as among mobile stations (Inter-Vehicle Communications) aimed at the following:

- Conveyance and exchange of information that contributes to reducing the number of traffic accidents.
- Conveyance and exchange of information that contributes to assisting safe driving.

2.3.1 Requirements of the system

This system provides high speed, short distance radio communications between base stations and mobile stations as well as among mobile stations, and has the following features:

- A high degree of frequency reuse with small area communication zones
- High capacity, high speed and low latency communications
- Broadcast communications by base stations and mobile stations

These features are expected to be used primarily by applications for assisting safe driving. Also, the following connectivity functions are intended, but not specified as part of this standard:

- Connectivity with a GPS device that provides information on its own vehicle
- Connectivity with an interior display device that shows on other vehicles
- Connectivity with a device that gathers traffic information

The radio communication requirements of this system shall be as follows:

- To be comprised with base stations and mobile stations, and radio communications among them
- To operate with a single channel in the 700 MHz band, and accommodate both Roadside-to-Vehicle and Inter-Vehicle Communications
- To support Inter-Vehicle Communications at a relative speed up to 140 km/h
- To support Roadside-to-Vehicle Communications at a vehicle speed of up to 70 km/h

2.3.2 Services provided by this system

The following services are intended to be provided by this system:

- Conveyance and exchange of information that contributes to reducing the number of traffic accidents
- Conveyance and exchange of information that contributes to assisting safe driving

— Other information providing services

2.4 Radio communication method

2.4.1 Transmission method

This system adopts Orthogonal Frequency Division Multiplexing (OFDM) as the modulation method. Table 2-1 summarizes the parameters related to the modulation and coding of this system:

Table 2-1 Specification of the modulation and coding method

Item	Parameter
Radio frequency	Single frequency in 700 MHz band
Frequency selection	Not required (fixed)
Error correction	Convolution FEC R=1/2, 3/4
Modulation	BPSK/OFDM, QPSK/OFDM, 16QAM/OFDM

2.4.2 Access method

As this system accommodates both Roadside-to-Vehicle and Inter-Vehicle Communications while it is operated with a single channel, it assigns different time periods for transmissions by base stations and mobile stations respectively. Base stations broadcast within their designated time period, while mobile stations follow the Carrier Sense Multiple Access / Collision Avoidance (CSMA/CA) access method within their designated time period.

2.5 Protocol

2.5.1 Protocol stack

Figure 2-2 shows the protocol stack of this system. The broken line in the figure indicates the scope of this standard. The standard refers to the OSI reference model when defining functional features at each layer, and specifies the following four layers: Layer 1 (L1: Physical Layer), Layer 2 (L2: Data Link Layer), IVC-RVC Layer (Inter-Vehicle and Roadside-to-Vehicle Communication Layer) and Layer 7 (L7: Application Layer). It also specifies primitives between Layer 7 and applications as well as between Layer 7 and the security management service.

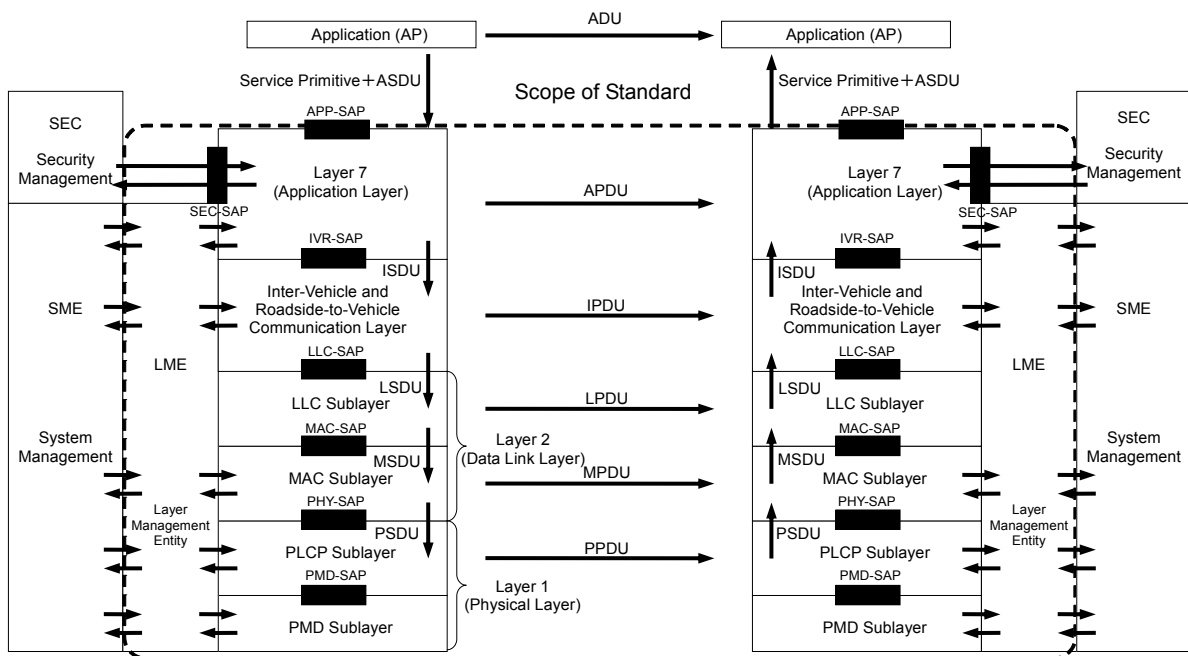

Figure 2-2 Protocol stack of this standard

2.5.1.1 Features of Layer 1

Layer 1 primarily functions as described in Document [1]. Details are specified in 4.2.

2.5.1.2 Features of Layer 2

Layer 2 is composed of the Medium Access Control (MAC) sublayer and Logical Link Control (LLC) sublayer.

The MAC sublayer follows the CSMA/CA access method for Inter-Vehicle Communications.

As CSMA/CA accommodates variable data length and transmission intervals very flexibly, it supports frequent inter-vehicle connectivity changes, which is highly suited to low latency yet high quality communications for assisting safe driving. Telecommunications management of the radio channel in the MAC sublayer supports "Frame control" and "Broadcast communication".

The LLC sublayer provides the "connection-less" service described in Document [2], which allows packet exchanges at higher layers. It also identifies the higher layer protocol by running the Subnetwork Access Protocol (SNAP) described in Document [3].

Layer 2 details are specified in 4.3.

2.5.1.3 Features of Inter-Vehicle and Roadside-to-Vehicle Communication Layer

The IVC-RVC Layer generates and manages information necessary for Inter-Vehicle Communications and Roadside-to-Vehicle Communications to operate on a single channel, and provides such information to the MAC sublayer. The interactions between IVC-RVC Layer and the MAC sublayer realize alternation of the two different modes without having a high level of interference with each other. Details of the IVC-RVC Layer are specified in 4.4.

2.5.1.4 Features of Layer 7

Layer 7 provides applications with data communication means and services via the IVC-RVC Layer. It also manages the applications in cooperation with the IVC-RVC Layer. Details of Layer 7 are specified in 4.5.

2.5.1.5 Internet protocol

This standard does not specify an Internet Protocol (IP).

2.5.2 Numbering plan (Addressing)

This System uses the link address (MAC address) as the identifier for base stations and mobile stations. This address is also used as the identifiers at Service Access Points (SAPs) of Layers 1, Layer 2 and Layer 7 as well as IVC-RVC Layer. Note that this standard does not specify how those identifiers are generated.

2.6 Security method

This standard does not specify a security method.

Empty page

Chapter 3 General Requirements and Technical Requirements for Radio Equipment

This chapter specifies the technical requirements for radio facilities and equipment conforming to the governing regulations and technical operational conditions noted in 1.4.

3.1 General requirements

3.1.1 Communication method

(ORE: Article 49-22-2)

The communication method shall be broadcast communication, one-way communication method or simplex communication method.

3.1.2 Content of communication

The content of communication shall be digitized data signal, image signal or audio signal.

3.1.3 Operating frequency band

(RERL: Article 4-4, NT: No.714, 2008, Revised NT: No.512, 2011)

The operating frequency band to be used shall be more than 755.5 MHz and 764.5 MHz or less. The center frequency shall be 760 MHz.

3.1.4 Security measures

To prevent unauthorized use of the system, security protection measures should be applied as needed.

3.2 Technical requirements for radio equipment

3.2.1 Transmitter

3.2.1.1 Antenna power

(ORE: Article 49-22-2)

The antenna power for the operating frequency band shall be 10 mW or less per 1 MHz bandwidth on average.

3.2.1.2 Antenna power tolerance

(ORE: Article 14)

The tolerance of the antenna power shall be within +20 %/-50 % for a base station, and shall be within +50 %/-50 % for a mobile station.

3.2.1.3 Frequency tolerance

(ORE: Article 5, Table 1)

The frequency tolerance shall be 20×10^{-6} or less.

3.2.1.4 Modulation

(ORE: Article 49-22-2)

The modulation method shall be Orthogonal Frequency Division Multiplexing (OFDM).

3.2.1.5 Occupied bandwidth

(ORE: Article 6, Table 2)

The occupied bandwidth shall be 9 MHz or less.

3.2.1.6 Transmission data rate

(ORE: Article 49-22-2)

The transmission data rate shall be 5 Mb/s or more.

3.2.1.7 Permissible values for unwanted emission intensity

(ORE: Article 7, Table 3)

The permissible values for unwanted emission intensity shall be as specified in 0 for a base station and 0 for a mobile station.

Table 3-1 Unwanted emission intensity (base station)

Frequency band	Emission limit (average power)
710 MHz or less	2.5 μ W or less per 100 kHz bandwidth
More than 710 MHz and 750 MHz or less	20 nW or less per 100 kHz bandwidth
More than 750 MHz and 755 MHz or less	0.1 mW or less per 100 kHz bandwidth
More than 765 MHz and 770 MHz or less	0.1 mW or less per 100 kHz bandwidth
More than 770 MHz and 810 MHz or less	0.32 nW or less per 100 kHz bandwidth
More than 810 MHz and 1 GHz or less	2.5 μ W or less per 100 kHz bandwidth
More than 1 GHz	2.5 μ W or less per 1 MHz bandwidth

Table 3-2 Unwanted emission intensity (mobile station)

Frequency band	Emission limit (average power)
710 MHz or less	2.5 μ W or less per 100 kHz bandwidth
More than 710 MHz and 750 MHz or less	20 nW or less per 100 kHz bandwidth
More than 750 MHz and 755 MHz or less	0.1 mW or less per 100 kHz bandwidth
More than 765 MHz and 770 MHz or less	0.1 mW or less per 100 kHz bandwidth
More than 770 MHz and 810 MHz or less	10 nW or less per 100 kHz bandwidth
More than 810 MHz and 1 GHz or less	2.5 μ W or less per 100 kHz bandwidth
More than 1 GHz	2.5 μ W or less per 1 MHz bandwidth

3.2.1.8 Modulation accuracy

The modulation accuracy shall be as specified in 4.2.3.8.2.

3.2.2 Receiver

3.2.2.1 Limits of incidentally produced radiation

(ORE: Article 24)

The limit on secondary radiated emissions shall be as specified in 0 for a base station and 0 for a mobile station.

Table 3-3 Limits of incidentally produced radiation (base station)

Frequency band	Limits of incidentally produced radiation
770 MHz or less	4 nW or less per 100 kHz bandwidth
More than 770 MHz and 810 MHz or less	0.32 nW or less per 100 kHz bandwidth
More than 810 MHz and 1 GHz or less	4 nW or less per 100 kHz bandwidth
More than 1 GHz	4 nW or less per 1 MHz bandwidth

Table 3-4 Limits of incidentally produced radiation (mobile station)

Frequency band	Limits of incidentally produced radiation
1 GHz or less	4 nW or less per 100 kHz bandwidth
More than 1 GHz	4 nW or less per 1 MHz bandwidth

3.2.2.2 Reception sensitivity

The reception sensitivity shall be as specified in 4.2.3.9.1.

3.2.2.3 Maximum input power for reception

The maximum input power for reception shall be -20 dBm. The error rate for packets with a PSDU length of 1,000 octets shall be less than 10% when this power is fed into the antenna connector. (Refer to Figure 4-2).

3.2.2.4 Blocking characteristics

The blocking characteristics performance is measured by feeding a signal by this system into the antenna connector at 3 dB over the reception sensitivity level specified in 4.2.3.9.1, while concurrently feeding an interference signal specified in Table 3-5 for a base station and Table 3-6 for a mobile station. The error rate for packets with the PSDU length of 1,000 octets shall be less than 10% under this condition. (Refer to Figure 4-2)

Table 3-5 Interference signal (base station)

Frequency band	Interference signal
More than 710 MHz and 748 MHz or less	-7 dBm
More than 773 MHz and 810 MHz or less	-7 dBm

Table 3-6 Interference signal (mobile station)

Frequency band	Interference signal
More than 710 MHz and 748 MHz or less	-21 dBm
More than 773 MHz and 810 MHz or less	-21 dBm

3.2.3 Controller

3.2.3.1 Interference prevention function

(RERL: Article 6-2, ORE: Article 9-4, NT: No.446, 2012)

The radio equipment of each mobile station shall automatically transmit/receive an identification code that is managed by an organization approved by the Minister for Internal Affairs and Communications.

3.2.3.2 Carrier sense function

(ORE: Article 49-22-2, NT: No.444, 2012)

(1) Base station

Base stations are not required to perform assessment of the channel availability before transmitting signals.

(2) Mobile station

A mobile station shall not transmit a signal if a power of -53 dBm or more is detected at the antenna connector.

3.2.3.3 Transmission time control function

(ORE: Article 49-22-2, NT: No.444, 2012)

(1) Base station

The total transmission time in arbitrary 100 ms shall be 10.5 ms or less.

(2) Mobile station

The total transmission time in arbitrary 100 ms shall be 0.66 ms or less, and the transmission burst length shall to be 0.33 ms or less.

3.2.4 Antenna

3.2.4.1 Antenna structure

This standard does not specify the antenna structure.

3.2.4.2 Antenna polarization

The antenna should have vertical polarization.

3.2.4.3 Antenna gain

(ORE: Article 49-22-2)

The absolute gain of the transmission antenna shall be 0 dBi or less. However, in the case where EIRP is less than the value 0 dB added by the maximum antenna power specified in 3.2.1.1, it is allowed to compensate for the difference by an antenna gain of 13 dB for a base station and 5 dB for a mobile station respectively.

3.2.4.4 Antenna installation

The height of an antenna should be around 4.7 m to 7.0 m for a base station and around 1.0 m to 3.0 m for a mobile station.

3.2.5 Other

3.2.5.1 Cabinet

(ORE: Article 49-22-2, OTF: Article 9, NT: No.444, 2012)

The cabinet shall be of tamper-proof construction. However, this provision does not apply to the power supply equipment, antenna and the following equipment specified in the Notification of the Ministry of Internal Affairs and Communications.

The following radio equipment does not need to be contained within the same cabinet.

- (1) Displays indicating the operation status of transmitter equipment and receiver equipment
- (2) Accessory equipment for data processing and other parts subjected to the same category
- (3) Signal processing equipment

3.2.5.2 Mark in relation to technical regulations conformity certification

(OTRCC: Article 8)

A mark in relation to technical regulations conformity certification in the specified format shall be visibly displayed on the radio equipment.

3.3 Connection to telecommunication circuit

All terminal equipment or private telecommunication equipment that is connected to the telecommunication circuit equipment shall meet the following conditions:

3.3.1 Identification code

(OTF: Article 9, NT: No.424, 1994, NT: No.537, 2011)

The coding length of the identification code shall be 48 bits or more.

3.3.2 Detection of the availability of the operating frequency band

(OTF: Article 9, NT: No.424, 1994, NT: No.537, 2011)

Detection is not necessary for a base station. Detection should be performed in a mobile station when the receiver input power is less than -53 dBm.

3.3.3 Mark in relation to technical requirements compliance approval for terminal equipment

(RTCCA: Article 10)

In the case where radio equipment is connected to telecommunication circuit equipment, a mark in relation to technical requirements compliance approval for terminal equipment in the specified format shall be visibly displayed on it.

Empty page

Chapter 4 Communication Control System

4.1 Overview

This chapter specifies the communication control system for the radio communication interfaces of this system. This system is composed of a four layer-structure, namely, Layer 1 (physical layer), Layer 2 (data link layer), Inter-vehicle Communication and Roadside-to-vehicle Communication Control Layer (IVC-RVC Layer), and Layer 7 (application layer).

Layer 1 consists of a physical medium dependent (PMD) sublayer and a physical layer convergence protocol (PLCP) sublayer. The PMD sublayer provides a method for transmission and reception of data between stations that utilize the OFDM system. The PLCP sublayer provides a function to adapt the PMD sublayer to services of the Physical Layer.

Layer 2 consists of a MAC sublayer and an LLC sublayer. Carrier sense multiple access / collision avoidance (CSMA/CA) is used as a communication control method of the MAC sublayer. The LLC sublayer provides an unacknowledged connectionless-mode service to transmit packets between entities of the upper layer.

The IVC-RVC Layer generates and manages information required for inter-vehicle communication and roadside-to-vehicle communication control, and specifies a method to provide parameters needed for communication control for the MAC sublayer.

Layer 7 provides a communication control method and services for application, and specifies a method for transmission and reception of data through the IVC-RVC Layer.

4.1.1 Overview of relationship between layers, layer management and system management

Figure 4-1 shows an overview of the relationship between layers, layer management and the system management service. An entity of each layer provides a data transmission service for a higher layer. Each layer management entity has a management information base (MIB), and provides access services for the higher layer management entities or the system management entity. The system management entity provides services for management information service users.

Each MIB is a virtual information database consisting of variables or parameters utilized for elements of procedures of each layer. Access to the MIB in the same layer is executed as a direct reference, and access to the MIB in another layer is executed as an indirect reference using the service primitives provided by each layer.

The service primitives and details of MIB for each layer, layer management entity and system management are specified in the layer standards.

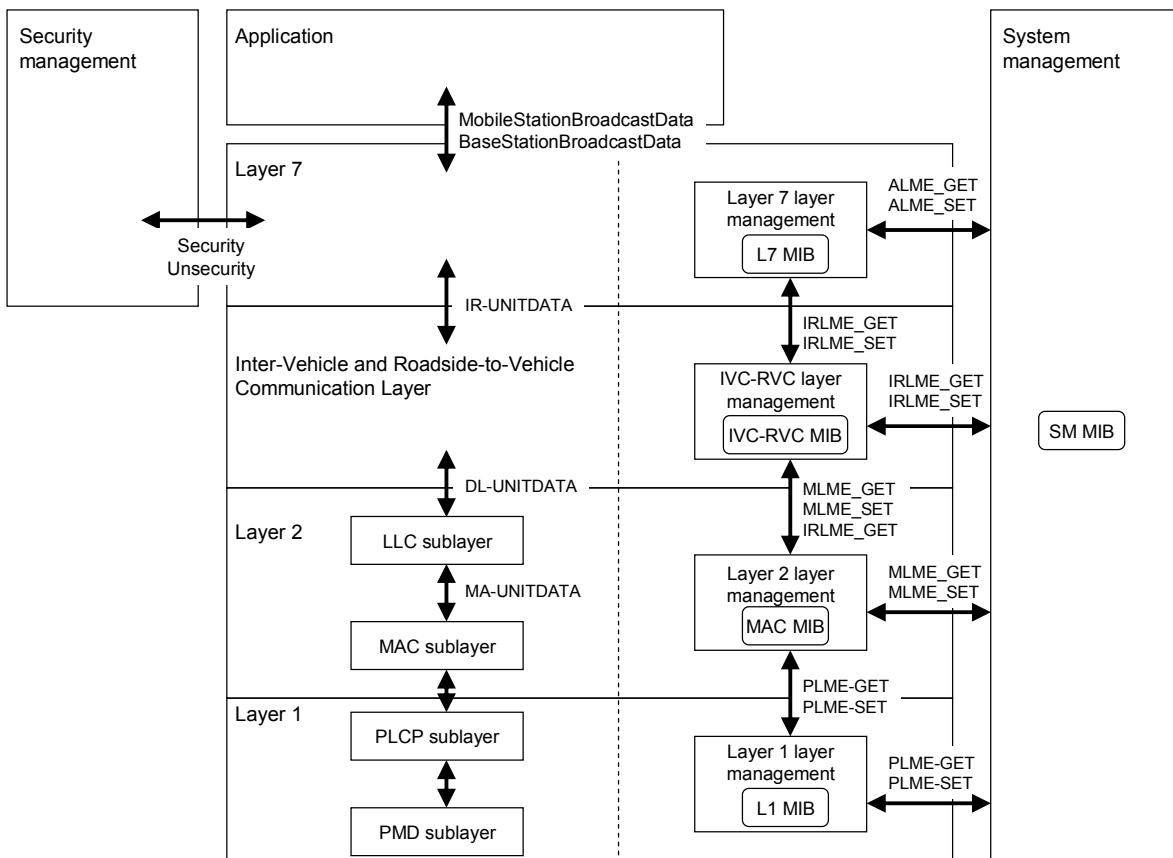

Figure 4-1 Overview of relationship between layers, layer management and system management

4.2 Layer 1 (Physical Layer) standards

4.2.1 Overview

In this section, the PHY layer technical requirements are specified, including the structure of the frame, the structure of channels, the structure of signals, etc.

Layer 1 in Figure 4-1 consists of three sublayers, the Physical Medium Depending (PMD) sublayer, which specifies the Physical Layer Protocol Data Unit (PPDU) between units of radio equipment, the Physical Layer Convergence Protocol (PLCP) sublayer, which converts the frame format between the MAC sublayer and the PMD sublayer and the Physical Layer Management Entity (PLME), which manages the Physical Layer. A base station that does not have the function with respect to the reception of frames or assessment of the channel availability does not need to meet the specifications regarding these functions.

4.2.2 Interface service specification of Physical Layer

4.2.2.1 Specification of service

4.2.2.1.1 PHY-DATA.request

The PHY-DATA.request shall be specified as described in “12.3.5.1 PHY-DATA.request” of Document [1].

4.2.2.1.2 PHY-DATA.indication

The PHY-DATA.indication shall be specified as described in “12.3.5.2 PHY-DATA.indication” of Document [1].

4.2.2.1.3 PHY-DATA.confirm

The PHY-DATA.confirm shall be specified as described in “12.3.5.3 PHY-DATA.confirm” of Document [1].

4.2.2.1.4 PHY-TXSTART.request

The PHY-TXSTART.request shall be specified as described in “12.3.5.4 PHY-TXSTART.request” of Document [1]. The “TXVECTOR” is specified in 4.2.2.2.1.

4.2.2.1.5 PHY-TXSTART.confirm

The PHY-TXSTART.confirm shall be specified as described in “12.3.5.5 PHY-TXSTART.confirm” of Document [1].

4.2.2.1.6 PHY-TXEND.request

The PHY-TXEND.request shall be specified as described in “12.3.5.6 PHY-TXEND.request” of Document [1].

4.2.2.1.7 PHY-TXEND.confirm

The PHY-TXEND.confirm shall be specified as described in “12.3.5.7 PHY-TXEND.confirm” of Document [1].

4.2.2.1.8 PHY-CCARESET.request

The PHY-CCARESET.request shall be specified as described in “12.3.5.8 PHY-CCARESET.request” of Document [1].

4.2.2.1.9 PHY-CCARESET.confirm

The PHY-CCARESET.confirm shall be specified as described in “12.3.5.9 PHY-CCARESET.confirm” of Document [1].

4.2.2.1.10 PHY-CCA.indication

The PHY-CCA.indication shall be specified as described in “12.3.5.10 PHY-CCA.indication” of Document [1].

4.2.2.1.11 PHY-RXSTART.indication

The PHY-RXSTART.indication shall be specified as described in “12.3.5.11 PHY-RXSTART.indication” of Document [1]. The “RXVECTOR” is specified in 4.2.2.2.2.

4.2.2.1.12 PHY-RXEND.indication

The PHY-RXEND.indication shall be specified as described in “12.3.5.12 PHY-RXEND.indication” of Document [1].

4.2.2.2 Service parameters

4.2.2.2.1 TXVECTOR parameters

The TXVECTOR parameters shall be specified as described in “17.2.2 TXVECTOR parameters” of Document [1]. In this system, 3, 4.5, 6, 9, 12 and 18 Mb/s of 10 MHz channel spacing and “1” of the “TXPWR LEVEL” shall be selected.

4.2.2.2.2 RXVECTOR parameters

The PHY-DATA.request shall be specified as described in “17.2.3 RXVECTOR parameters” of Document [1]. In this system, 3, 4.5, 6, 9, 12 and 18 Mb/s of 10 MHz channel spacing shall be selected.

4.2.3 Physical Layer Convergence Protocol (PLCP) sublayer

4.2.3.1 Frame format

The frame format shall be specified as described in “17.3.2 PLCP frame format” of Document [1]. In this system, BPSK, QPSK and 16QAM of 10 MHz channel spacing shall be selected.

4.2.3.2 Preamble

The preamble shall be specified as described in “17.3.3 PLCP preamble (SYNC)” of Document [1]. In this system, 10 MHz channel spacing shall be selected.

4.2.3.3 Signal field

The signal field shall be specified as described in “17.3.4 SIGNAL field” of Document [1]. In this system, 3, 4.5, 6, 9, 12 and 18 Mb/s of 10 MHz channel spacing shall be selected.

4.2.3.4 Data field

The data field shall be specified as described in “17.3.5 DATA field” of Document [1]. In this system, BPSK, QPSK and 16QAM of 10 MHz channel spacing shall be selected.

4.2.3.5 Detection of the operating channel (clear channel assessment)

The detection of the operating channel shall be specified as described in “17.3.6 CCA” of Document [1].

4.2.3.6 Data modulation and modulation rate change

The data modulation and modulation rate change shall be specified as described in “17.3.7 PLCP data modulation and modulation rate change” of Document [1].

4.2.3.7 General specification of PMD sublayer

4.2.3.7.1 Overview

The overview shall be specified as described in “17.3.8.1 Outline description” of Document [1]. In this system, BPSK, QPSK and 16QAM of 10 MHz channel spacing shall be selected, and 1/2 and 3/4 of the coding rate shall be selected.

4.2.3.7.2 TX RF delay

The TX RF delay shall be specified as described in “17.3.8.5 TX RF delay” of Document [1].

4.2.3.7.3 Slot time

The slot time shall be specified as described in “17.3.8.6 Slot time” of Document [1]. In this system, 10 MHz channel spacing shall be selected.

(The “dot11RegulatoryClassesRequired” shall be “false” and the “Slot time” shall be “0” for “coverage class” in “Table 7-27”.)

4.2.3.7.4 Antenna port impedance

The antenna port impedance shall be specified as described in “17.3.8.7 Transmit and receive antenna port impedance” of Document [1].

4.2.3.8 PMD transmitter specifications

4.2.3.8.1 Symbol clock frequency tolerance

The symbol clock frequency tolerance shall be specified as described in “17.3.9.5 Symbol clock frequency tolerance” of Document [1]. In this system, 10 MHz channel spacing shall be selected.

4.2.3.8.2 Modulation accuracy

(1) Transmitter center frequency leakage

The transmitter center frequency leakage shall be specified as described in “17.3.9.6.1 Transmitter center frequency leakage” of Document [1].

(2) Transmitter spectral flatness

The Transmitter spectral flatness shall be specified as described in “17.3.9.6.2 Transmitter spectral flatness” of Document [1].

(3) Transmitter constellation error

The transmitter constellation error shall be specified as described in “17.3.9.6.3 Transmitter constellation error” of Document [1]. In this system, BPSK, QPSK and 16QAM shall be selected.

4.2.3.8.3 Transmit modulation accuracy test

The transmit modulation accuracy test shall be specified as described in “17.3.9.7 Transmit

modulation accuracy test” of Document [1].

4.2.3.9 PMD receiver specifications

4.2.3.9.1 Receiver minimum input sensitivity

The receiver minimum input sensitivity shall be specified as described in “17.3.10.1 Receiver minimum input sensitivity” of Document [1]. In this system, BPSK, QPSK and 16QAM of 10 MHz channel spacing shall be selected.

4.2.3.9.2 CCA sensitivity

The CCA sensitivity shall be specified as described in “17.3.10.5 CCA sensitivity” of Document [1]. In this system, 10 MHz channel spacing shall be selected.

4.2.3.10 Transmit PLCP

The transmit PLCP shall be specified as described in “17.3.11 Transmit PLCP” of Document [1]. However, the base station is allowed to issue “PHY-TXSTART.request (TXVECTOR)” even if the base station has not received the “PHY-CCA.indication (IDLE)”.

4.2.3.11 Receive PLCP

The receive PLCP shall be specified as described in “17.3.12 Receive PLCP” of Document [1].

4.2.4 Physical Layer Management Entity

4.2.4.1 Management primitives

4.2.4.1.1 PLME-GET

The PLME-GET shall be specified as described in “10.2 Generic management primitives” of Document [1].

4.2.4.1.2 PLME-SET

The PLME-SET shall be specified as described in “10.2 Generic management primitives” of Document [1].

4.2.4.1.3 PLME-RESET.request

The PLME-RESET.request shall be specified as described in “10.4.1 PLME-RESET.request” of Document [1].

4.2.4.1.4 PLME-TXTIME.request

The PLME-TXTIME.request shall be specified as described in “10.4.6 PLME-TXTIME.request” of Document [1].

4.2.4.1.5 PLME-TXTIME.confirm

The PLME-TXTIME.confirm shall be specified as described in “10.4.7 PLME-TXTIME.confirm” of Document [1].

4.2.4.2 PHY MIB

The PHY MIB shall be specified as described in “17.4.2 OFDM PHY MIB” of Document [1]. In this system, parameters in Annex 1 shall be selected. And 3, 4.5, 6, 9, 12 and 18 Mb/s of 10 MHz channel spacing shall be selected for “Supported data rates Tx value” and “Supported data rates Rx value”.

4.2.4.3 TXTIME calculation

The TXTIME calculation shall be specified as described in “17.4.3 OFDM TXTIME calculation” of Document [1].

4.2.4.4 PHY characteristics

The PHY characteristics shall be specified as described in “17.4.4 OFDM PHY characteristics” of Document [1]. In this system, “aSlotTime”, “aCCATime”, “aPHY-RX-START-Delay”, “aRxTxTurnaroundTime”, “aTxPLCPDelay”, “aRxPLCPDelay”, “aRxTxSwitchTime”, “aTxRampOnTime”, “aTxRampOffTime”, “aTxRFDelay”, “aRxRFDelay”, “aAirPropagationTime”, “aMACProcessingDelay”, “aPreambleLength” and “aPLCPHeaderLength” of 10 MHz channel spacing in Table 17-15 shall be selected.

4.2.5 PMD sublayer

4.2.5.1 Scope and field of application

The scope and field of application shall be specified as described in “17.5.1 Scope and field of application” of Document [1].

4.2.5.2 Overview of service

The overview of the service shall be specified as described in “17.5.2 Overview of service” of Document [1].

4.2.5.3 Overview of interactions

The overview of interactions shall be specified as described in “17.5.3 Overview of interactions” of Document [1].

4.2.5.4 Basic service and options

The basic service and options shall be specified as described in “17.5.4 Basic service and options” of Document [1]. In this system, BPSK, QPSK and 16QAM of 10 MHz channel spacing in Table 17-18 shall be selected, and “1” shall be selected for the “TXPWR_LEVEL”.

4.2.5.5 Detailed service specification

The detailed service specification shall be specified as described in “17.5.5 PMD_SAP detailed service specification” of Document [1].

4.3 Layer 2 (Data Link Layer) standards

4.3.1 Overview

Layer 2, as a data link layer, specifies a medium access control (MAC) sublayer and a logical link control (LLC) sublayer.

The MAC sublayer manages the physical medium channel of Layer 1. The LLC sublayer performs data exchange between LLC sublayers and provides its service for the IVC-RVC Layer.

This section specifies the frame structure, elements for procedures and procedures for performing the above operations.

4.3.2 Protocol data unit

This section specifies the protocol data unit (PDU) of the MAC sublayer and the LLC sublayer in Layer 2.

The MAC protocol data unit (MPDU) in Layer 2 consists of a MAC Control field, an LLC Control field, an LLC service data unit (LSDU) and a frame check sequence (FCS) as shown in Figure 4-2. The length of the LLC protocol data unit (LPDU) shall be integral multiples of 1 octet.

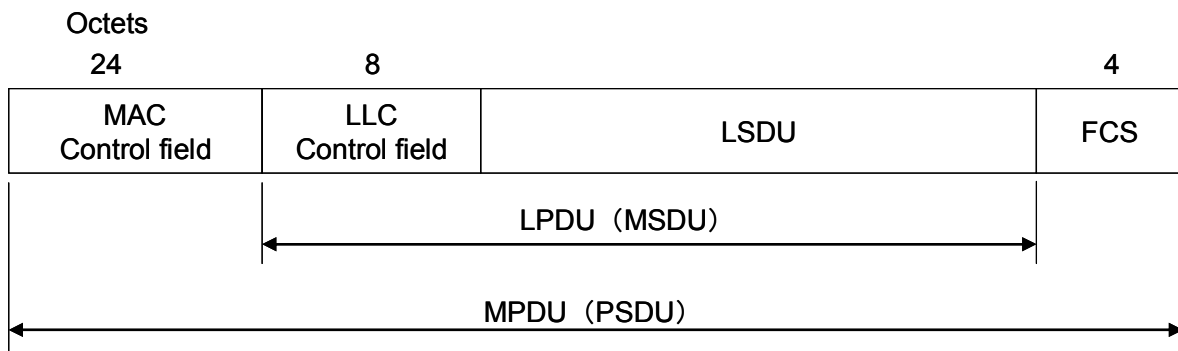

Figure 4-2 Configuration of Layer 2 MAC protocol data unit (PMDU)

4.3.2.1 MAC Control field

Figure 4-3 shows the structure of the MAC Control field.

Octets 2	2	6	6	6	2
Frame Control	Duration Period	Destination Address	Source Address	Wireless Call Number	Transmission Count

Figure 4-3 Configuration of MAC Control field

4.3.2.1.1 Frame Control field

Figure 4-4 shows the structure of the Frame Control field. The length of the Frame Control field is 16 bits. Bit number B3 shall be set to one and other bits shall be set to 0.



Figure 4-4 Configuration of Frame Control field

4.3.2.1.2 Duration Period field

Figure 4-5 shows the structure of the Duration Period field. The length of the Duration Period field is 16 bits. Bit number B15 and B14 shall be set to one and other bits shall be set to 0.

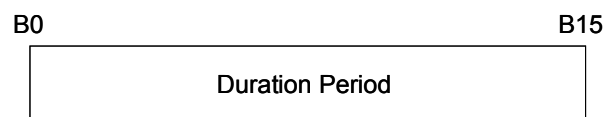

Figure 4-5 Configuration of Duration Period field

4.3.2.1.3 Destination Address field

The Destination Address field shall be set to the address of the destination mobile station. Details are specified in 4.3.3.

4.3.2.1.4 Source Address field

The Source Address field shall be set to the address of the source mobile station. Details are specified in 4.3.3.

4.3.2.1.5 Wireless Call Number field

The Wireless Call Number field shall be set to the identification code specified in 3.2.3. This field shall not be referred to as the MAC Control field.

4.3.2.1.6 Transmission Count field

Figure 4-6 shows the structure of the Transmission Control field. The length of the Transmission Count field is 16 bits. The bit number from B0 to B3 shall be set to 0. The bit number from B4 to B15 shall be incremented by one when a MPDU is transmitted, and shall be reset to “0x000” when the value reaches “0xFF”.

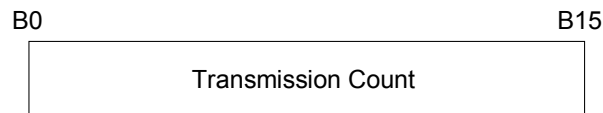

Figure 4-6 Configuration of Transmission Count field

4.3.2.2 LLC Control field

The LLC Control field is 8 octets and consists of fields from the DSAP Address field to the Protocol Identifier field, which are shown in Figure 4-14 in 4.3.5.3.1.

4.3.2.3 FCS field

The FCS field shall be specified as described in “7.1.3.7 FCS field” of Document [1].

4.3.2.4 Bit order

Each field shall be transmitted by the least significant bit (LSB) first. The FCS field is transmitted commencing with the coefficient of the highest-order term. An SDU, which is passed from an upper layer, shall be fragmented into 8-bit units, and each fragment shall be transmitted LSB first from the first byte.

4.3.3 Link address (MAC address)

The length of the link address (MAC address) is 48 bits, and the structure of the link address

is shown in Figure 4-7. This specification shall be applied to the Destination Address field and the Source Address field specified in 4.3.2.1.

The Destination Address field shall be the broadcast address whose bits are set to be 1. The broadcast address is used for broadcast communication to all base stations and mobile stations, and they shall comprehend the broadcast address.

Two bits from LSB in the first octet of the Source Address field shall be set to “01”, and the rest of the fields can be set to any values.

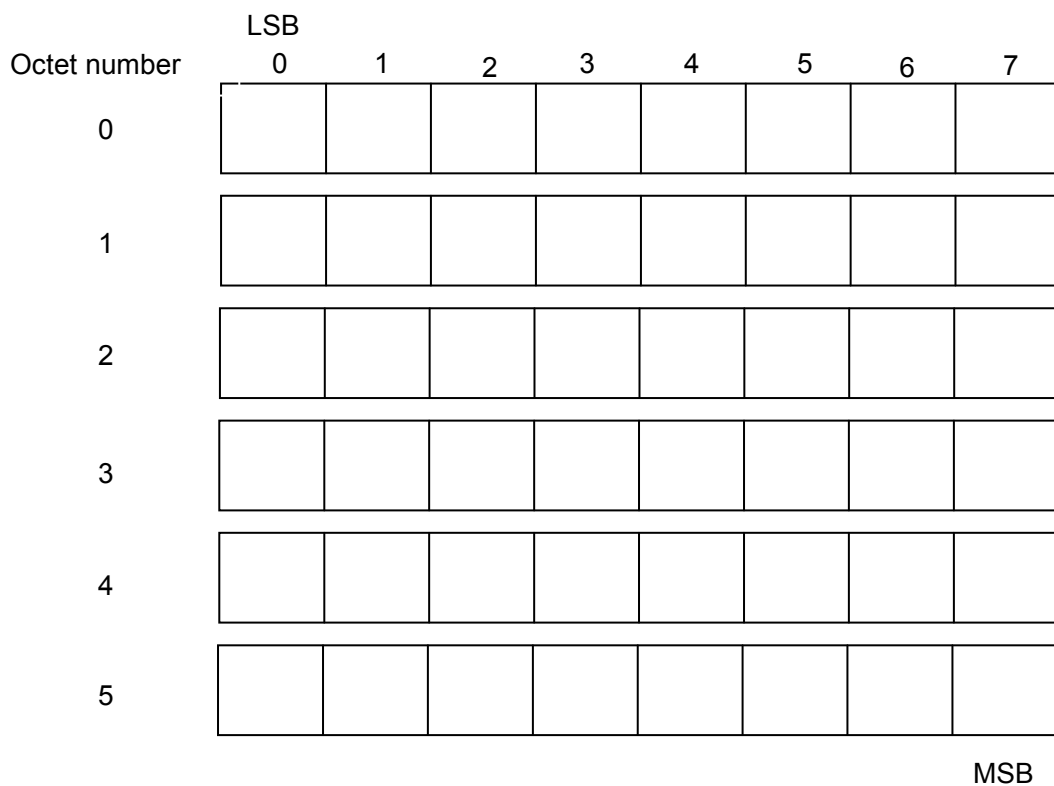

Figure 4-7 Configuration of link address (MAC address)

4.3.4 Medium access control (MAC) sublayer

4.3.4.1 Overview

4.3.4.1.1 Overview of services

The MAC sublayer manages the physical medium channel of Layer 1, and uses the CSMA/CA method as access control. The physical carrier sense function and the virtual carrier sense function are utilized to judge the medium condition.

The physical carrier sense function is provided by “PHY-CCA.indication”, which is passed from the PLSP sublayer through “PHY-SAP”. The virtual carrier sense function is provided by the transmission inhibition period, which is set based on the information of the IVC-RVC Layer.

The procedures and the elements for procedures are described by referring to the protocol data unit in the MAC sublayer specified in 4.3.2.

4.3.4.1.2 Definition of the services

This section specifies the access control for the physical medium channel of Layer 1. The access control for Layer 1 is used for the MAC sublayer entity residing in a base station and a mobile station. The MAC sublayer provides a data transmission service for the LLC sublayer.

The principal functions of the MAC sublayer are as follows:

- Generation of MPDU
- Transmission of MPDU
- CSMA control
- Management of the one second cycle timer for communication control
- Control of transmission inhibition period
- Insertion of the transmission time to the transmission frame

4.3.4.2 Specification of interface service of MAC sublayer

4.3.4.2.1 Overview of interactions between primitives

The MAC sublayer provides the LLC sublayer with the following primitives.

MA-UNITDATA.request

MA-UNITDATA.indication

MA-UNITDATA.request is passed from the LLC sublayer to the MAC sublayer to request the transmission of MAC service data unit (MSDU). MA-UNITDATA.indication is passed from the MAC sublayer to the LLC sublayer to indicate the arrival of MSDU.

4.3.4.2.2 Specification of service

This section specifies in detail the primitives and parameters associated with the service. The parameters (excluding "link address") are specified in an abstract way, and the information required on the receiver entity is also specified. A specific implementation is not constrained in the method of making this information available.

The “link address” is used to distinguish between SAPs of own station and SAPs of the remote station in the MAC sublayer and the LLC sublayer. The format of the “link address”

parameter is shown in Figure 4-7.

The “data” parameter may be provided by actually passing the MSDU or the pointer. The “data” parameter may be provided by other means.

Figure 4-8 shows the logical relationship between primitives.

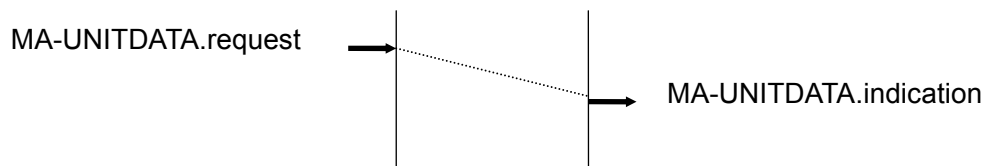

Figure 4-8 Logical relationship between primitives

(1) MA-UNITDATA.request

a) Function

This primitive is a service request primitive and shall be passed from the LLC sublayer to the MAC sublayer to request the transmission of an MSDU.

b) Semantics of service primitive

This primitive shall provide parameters as follows:

MA-UNITDATA.request (SequenceNumber, LinkAddress, data,
ControlInformation)

The “SequenceNumber” parameter shall be set to the parameters specified in 4.5.2.1.4(1). The “LinkAddress” parameter shall be set to the destination link address. The “data” parameter shall be set to the MSDU transmitted by the MAC entity. The “ControlInformation” parameter shall be set to the radio communication parameters specified in 4.5.2.1.4(2).

c) When generated

This primitive is generated by the LLC sublayer entity.

(2) MA-UNITDATA.indication

a) Function

This primitive shall be passed from the MAC sublayer to the LLC sublayer to indicate the successful reception of a valid MSDU.

b) Semantics of service primitive

This primitive shall provide parameters as follows:

MA-UNITDATA.indication (LinkAddress1, data, length, rxtime, LinkAddress3)

The “LinkAddress1” parameter shall be set to the destination private, group multicast, or broadcast link address. The “LinkAddress3” parameter shall be set to the wireless call number in the received MAC control field. The “data” parameter shall be set to the MSDU received by the MAC entity. The “length” parameter shall be set to the length of the MSDU, which is set to the “data” parameter. The “rxtime” parameter shall be set to the time when the MSDU is received.

c) When generated

This primitive is passed from the MAC sublayer to the LLC sublayer to indicate the arrival of a frame.

4.3.4.3 Function of MAC sublayer

4.3.4.3.1 Carrier sense function

This system specifies two kinds of carrier sense function: physical carrier sense function and virtual carrier sense function. The physical carrier sense function judges whether the medium is “BUSY” or “IDLE” by referring to the “PHY-CCA.indication”, which is passed from the PLCP sublayer through “PHY-SAP”. The virtual carrier sense function judges the medium as “BUSY” if transmission timing is within the transmission inhibition period, which is set based on the transmission inhibition period control variable specified in 4.4.3.2.2(5) and otherwise judges the medium as “IDLE”.

This system specifies two kinds of time spaces as an interval between frames: shortest space and distributed space. Both the shortest space and the distributed space are specified as an interval of medium timing, and shall be fixed value in any data rates.

The distributed space is specified as follows:

$$\text{Distributed Space} = \text{Shortest Space} + 2 \times \text{Slot Time}$$

The length of the shortest space shall be 32 μs, and that of the slot time is specified in 4.2.3.7.3.

4.3.4.3.2 Random waiting period

The base station or mobile station that starts the transmission of the MAC protocol data unit (MPDU) judges whether the medium is “BUSY” or “IDLE” by using the carrier sense function.

If the medium is BUSY, the station shall defer transmission for a period of distributed space after the last frame is received correctly. If the medium is IDLE for a period of time equal to the distributed space, a random waiting period, which is another deferral of frame transmission, shall be generated as specified in 4.3.4.4.1(2). This procedure can minimize the possibility of the collision of frames. Note that the random waiting period that is generated in the previous time shall be succeeded unless the current random waiting period is 0.

$$\text{Random Waiting Period} = \text{RANDOM} \times \text{Slot Time}$$

where RANDOM shall be a pseudo-random integer that is distributed uniformly from 0 to 63. Note that RANDOM shall be statistically independent among stations.

4.3.4.3.3 Management of one second cycle timer for communication control

The MAC sublayer manages a timer that controls Inter-Vehicle and Roadside-to-Vehicle Communication. The cycle of the timer is 1 second, and the value unit of the timer is in microseconds. The value of the timer shall vary from 0 to 999999, and it shall be corrected by the instruction from the IVC-RCV Layer. The value of the timer shall be corrected by referring to TC (corrected value of timer) when the TC in MIB is updated. The timer shall be put back if the TC is negative, and the timer shall be put forward if the TC is positive because the TC has a differential value.

4.3.4.3.4 Control of transmission inhibition period

In a base station, the MAC sublayer set the transmission inhibition period by referring to the transmission control variable when the one second cycle timer coincides with the time to set the transmission inhibition period. Details of the transmission control variable are specified in 4.4.3.2.1(2), and the procedures for setting the transmission inhibition period are specified in 4.3.4.5.1(3).

In a mobile station, the MAC sublayer sets the transmission inhibition period by referring to the transmission inhibition period control variable when the one second cycle timer coincides with the time to set the transmission inhibition period. Details of the transmission inhibition period control variable are specified in 4.4.3.2.2(5), and the procedures for setting the transmission inhibition period are specified in 4.3.4.5.2(3).

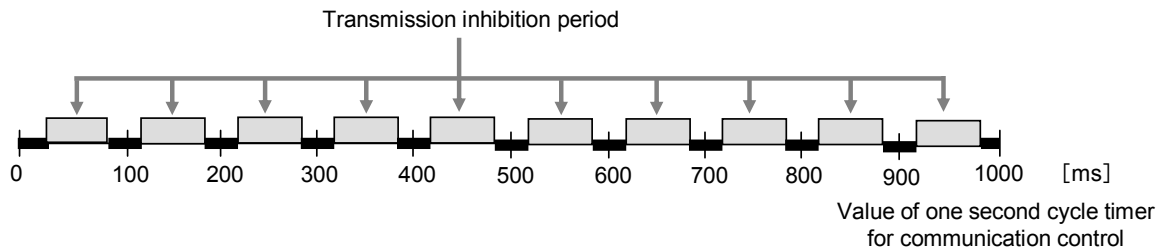

Figure 4-9 Relationship between one second cycle timer for communication control and transmission inhibition period

Figure 4-9 shows the relationship between the one second cycle timer and the transmission inhibition period. The control cycle of the roadside-to-vehicle communication period and the inter-vehicle communication period is 100 milliseconds, whereas the cycle of the timer is one second. If one transmission inhibition period is defined during the control cycle, ten transmission inhibition periods are set during the period of the one second cycle timer as shown in Figure 4-9.

4.3.4.3.5 Insertion of transmission time to transmission frame

The MAC sublayer sets the transmission time of the transmitted frame in the IR control field specified in 4.4.3.1.2. After termination of the random waiting period, the transmission time shall be set immediately before the frame is passed to the PLCP sublayer. The transmission time shall be the value of the one second cycle timer when the preamble of PLCP arrives at an antenna, so it shall be corrected with the delay time of going through Layer 1, which is measured in advance. The difference between the transmission time and the one second cycle timer shall be below plus or minus 2 μ s.

4.3.4.4 Access control

Two kinds of access control are specified in the MAC sublayer. One is the inter-vehicle and roadside-to-vehicle communication control to share the inter-vehicle communications and roadside-to-vehicle communications by timesharing. The other is the CSMA/CA control for inter-vehicle communications without a base station.

4.3.4.4.1 Inter-vehicle communication and roadside-to-vehicle communication control

(1) Access control based on virtual carrier sense function

If the medium is judged as “IDLE” by the virtual carrier sense function, a base station

shall be permitted to transmit a frame after a period of the shortest space. Frame transmission based on the virtual carrier sense function is shown in Figure 4-10.

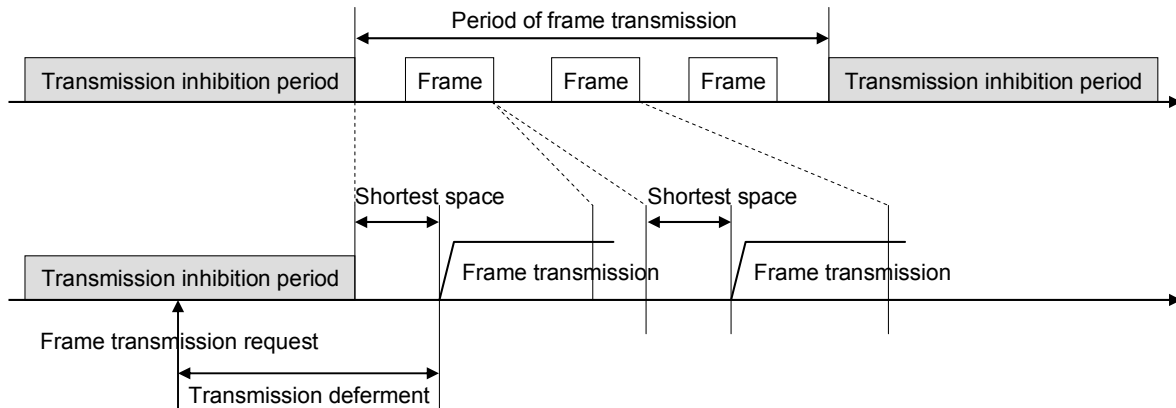

Figure 4-10 Frame transmission based on virtual carrier sense function

- 1) Wait until the medium is judged as “IDLE” by the virtual carrier sense function, i.e., wait until the transmission inhibition period has expired
- 2) Wait for a period of the shortest space
- 3) Transmit a frame when the period of the shortest space has expired
- 4) After transmitting the frame, Procedures 2) and 3) shall be executed if another frame is waiting to be transmitted
- 5) Repeat Procedure 4) until the medium is judged as “BUSY” by the virtual carrier sense function, i.e., until the transmission inhibition period begins

(2) Access control based on physical and virtual carrier sense function

If the medium is judged as “IDLE” by the virtual and physical carrier sense function over the distributed space period and random waiting period, a mobile station shall be permitted to transmit a frame. Frame transmission based on the physical and virtual carrier sense function is shown in Figure 4-11.

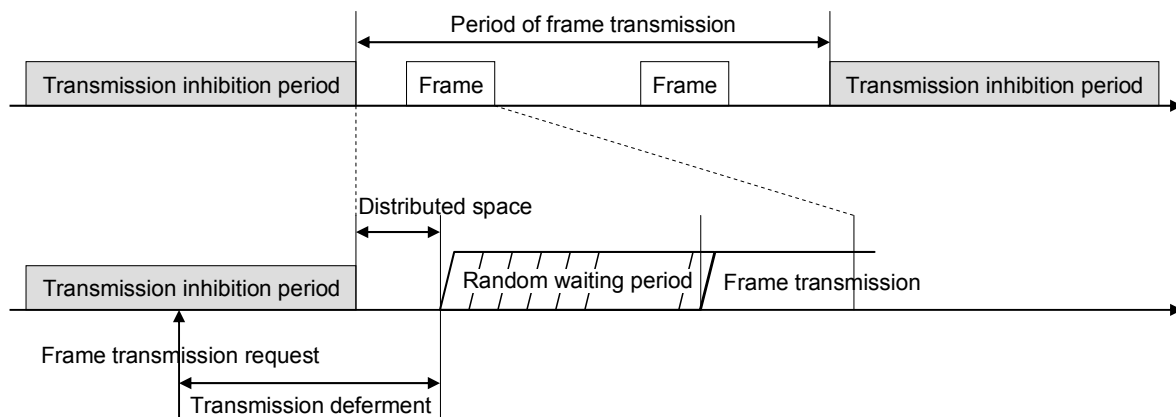

Figure 4-11 Frame transmission based on physical and virtual carrier sense function

- 1) Wait until the medium is judged as “IDLE” by the virtual carrier sense function, i.e., wait until the transmission inhibition period has expired.
- 2) Wait until the medium is judged as “IDLE” by the physical carrier sense function over the period of distributed space.
- 3) Generate a random integer value from 0 to 63, and determine the random waiting period, which is the product of the random value and the slot time.
- 4) After Procedure 2), the random waiting period that is determined in 3), shall be decreased every time the slot time elapses while the medium is judged as “IDLE” by the physical carrier sense function. If the random waiting period reaches 0, a MPDU is transmitted.
- 5) Wait until the medium becomes “IDLE” again if the medium is judged as “BUSY” by the physical carrier sense function during Procedure 4). If the medium becomes “IDLE”, Procedures 2) and 4) shall be executed again by using the random waiting period decreased in Procedure 4).
- 6) Procedure 5) shall be repeated until the medium is judged as “BUSY” by the virtual carrier sense function, i.e., until the transmission inhibition period begins.

4.3.4.5 Data transmission/reception control

4.3.4.5.1 Data transmission/reception control in a base station

(1) Procedures for data transmission

a) Maintenance and discard of MSDU

The MAC sublayer of a base station shall maintain MSDU, which is received from

LLC until the Roadside-to-Vehicle communication period. The base station shall check whether the number of maintained MSDU reaches the total number of "SequenceNumber". If all the "SequenceNumber" are assembled, the base station shall make a request of transmission to Layer 1 when the Roadside-to-Vehicle communication period in each control period (100 ms) starts. Before this operation, the base station shall request PLME-TXTIME to Layer 1 and get the transmission time. If the total transmission time including the short interframe space between packets exceeds 10.5 ms, the base station shall discard some MSDU so that the total transmission time is 10.5 ms or shorter. The base station shall also check whether all the packets can be transmitted within the Roadside-to-Vehicle communication period, and if the total transmission time including the short interframe space between packets exceeds the Roadside-to-Vehicle communication period, and the base station shall discard some MSDU so that the total transmission time is equal to the Roadside-to-Vehicle communication period or shorter. When plural Roadside-to-Vehicle communication periods are set, the base station shall check whether packets can be transmitted in each Roadside-to-Vehicle transmission time, and discard some packets so that all packets can be transmitted in all Roadside-to-Vehicle transmission periods if necessary. (Description 1 indicates an example of the calculation of time for transmitting plural packets consecutively.) If the number of maintained MSDU does not reach the total number of "SequenceNumber", the base station shall not make a request of transmission to Layer 1 and maintain the MSDU until the next control period. If the MAC sublayer receives two or more full sets of MSDU each of which completes all the packets indicated by "SequenceNumber", the base station shall maintain only the newest sets of MSDU and discard others.

b) Generation of MPDU

The base station generates MPDU by adding a MAC control field and an FCS field (shown in 4.3.2) to MSDU. The Destination Address field shall be set according to the parameters of "LinkAddress", which are received from the LLC sublayer, and the Source Address field shall be set according to the MAC address that is registered in MIB. The Wireless Call Number field shall also be set. When making a request of transmission to Layer 1, the base station shall set the timestamp in the IR control field, which is shown in 4.4.3.1.2, referring to 4.3.4.3.5 to determine what time to set to the timestamp.

c) Generation of parameters for TXVECTOR

The base station shall set DATARATE according to the "ControlInformation" parameter, which is received from the LLC sublayer, referring to TXVECTOR shown in 4.2.2.2.1.

d) Transmission request to Layer 1

The base station shall send MPDU to Layer 1 according to "Access Control based on Virtual Carrier Sense Function" in 4.3.4.4.1(1) and using the packet transmission procedure of Transmit PLCP shown in 4.2.3.10. When the base station sends MPDU to Layer 1, "RPC" in MIB shall be increased by "1". If "RPC" is "255" when sending the MPDU, "RPC" shall be reset to "0" and re-increased again.

(2) Procedures for data reception

When a MPDU arrives from Layer 1, the MAC sublayer of the base station shall send MA-UNITDATA.indication to the upper layer. The base station shall also set the frame reception time to the "rxtime" parameter. The frame reception time shall be the value of the one second cycle timer when the preamble of PLCP arrives at the antenna, so it must be corrected with the delay time of going through Layer 1, which is measured in advance.

(3) Procedures for setting of transmission inhibition period

The base station shall set the transmission inhibition period referring to "RTC" in the MIB of the IVC-RVC Layer. The transmission inhibition period shall be set to "all the time" except for each transmission period duration from transmission timing. Concretely, as shown in Figure 4-12, in each control cycle (100 ms), the transmission inhibition period shall be set except for the time when the value of less than 100 ms of the one second cycle timer is within the transmission period duration indicated by "RTC.TRP" from the transmission timing indicated by "RTC.TST". If the total transmission inhibition period in each control period is shorter than 89.5 ms, the base station shall add the transmission inhibition period to the time so that the transmission period duration is 10.5 ms or longer. This procedure shall be performed every time the "RTC" parameter is updated.

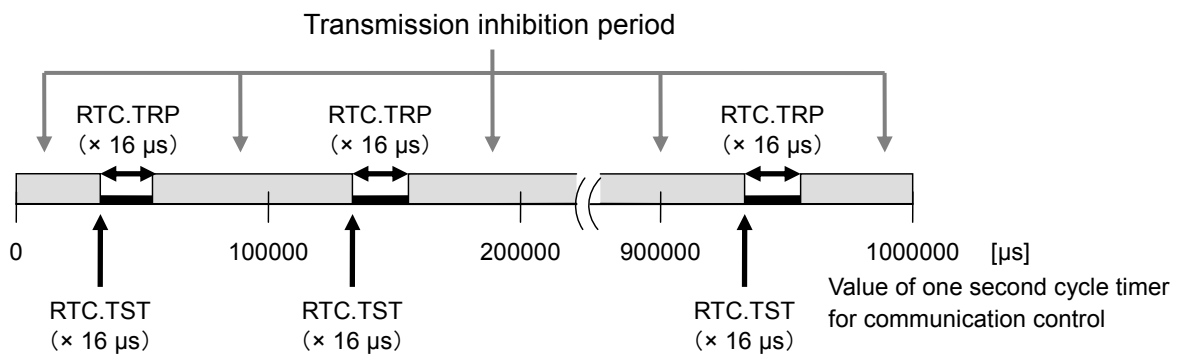

Figure 4-12 Procedures for setting of transmission inhibition period in a base station

4.3.4.5.2 Data transmission/reception control in mobile station

(1) Procedures for data transmission

a) Maintenance and discard of MSDU

The transmission time of MSDU, which is passed from the LLC sublayer, is acquired by PLME-TXTIME.request. If the transmission time exceeds 300 μs , the MSDU shall be discarded. A MSDU shall also be discarded if “Sequence” and “TotalNumber”, which are part of the primitive parameter “SequenceNumber”, are not 0. If a MSDU is passed from the LLC sublayer outside the period, which is judged BUSY by the virtual carrier sense function or physical carrier sense function, a MPDU shall be generated, and then a transmission request shall be issued to Layer 1. If a MSDU is passed from the LLC sublayer within a period that is judged “BUSY” by a virtual carrier sense function or a physical carrier sense function, the MSDU shall be maintained in the MAC sublayer. If the medium is judged “IDLE” by the virtual carrier sense function and the physical carrier sense function, a MPDU shall be generated and a transmission request is issued to Layer 1. Note that access control for the transmission of the MSDU shall begin after 100 ms has elapsed since the previous access control. If a new MSDU is passed from the LLC sublayer before the completion of the transmission of a MPDU to Layer 1 within 100 ms, the MSDU maintained in the MAC sublayer shall be discarded.

b) Generation of MPDU

The mobile station generates MPDU by adding MAC Control field and FCS field (shown in 4.3.2) to MSDU received from the LLC sublayer. The Destination Address field shall be set according to a parameter of “LinkAddress”, which is received from

the LLC sublayer, and the Source Address field shall be set according to the MAC address that is registered in MIB. The Wireless Call Number field shall also set an identification code. When making a request of transmission to Layer 1, the mobile station shall set the timestamp in the IR Control field, which is specified in 4.4.3.1.2, referring to 4.3.4.3.5 to determine what time to set the timestamp.

c) Generation of parameters for TXVECTOR

The mobile station shall set DATARATE according to the “ControlInformation” parameter, which is received from the LLC sublayer, referring to the TXVECTOR parameter specified in 4.2.2.2.1.

d) Transmission request to Layer 1

The mobile station shall send MPDU to Layer 1 by using the packet transmission procedure of Transmit PLCP specified in 4.2.3.10 according to the “Access Control based on physical and virtual carrier sense function” specified in 4.3.4.4.1(2). When the mobile station sends a MPDU to Layer 1, “OPC” in MIB shall be increased by “1”. “RPC” shall be reset to “0” and re-increase again when “OPC” reaches “255”.

(2) Procedures for data reception

When a MPDU arrives from Layer 1, the MAC sublayer of the mobile station shall send a MA-UNITDATA.indication to an upper layer. The mobile station shall also set the frame reception time to the “rxtime” parameter. The frame reception time shall be the value of the one second cycle timer when the preamble of PLCP arrives at an antenna, so it must be corrected with the delay time of going through Layer 1, which is measured in advance.

(3) Procedures for setting of transmission inhibition period

The mobile station shall set the transmission inhibition period referring to “ONC” in the MIB of the IVC-RVC Layer. Each period from the transmission timing to the end of the transmission inhibition period, which is defined by “ONC”, shall be set to the transmission inhibition period. Concretely, as shown in Figure 4-13, in each control cycle (100 ms), the period from the transmission timing (“ONC(1).NST”, which is indicated by the value of less than 100 ms of the one second cycle timer) to the end of transmission timing (the end of “ONC(1).NVP) shall be set to the transmission inhibition period. Figure 4-13 shows the case where one “ONC” is defined, and the maximum number of

“ONC” is 16. This procedure shall be performed every time the “RTC” parameter is updated.

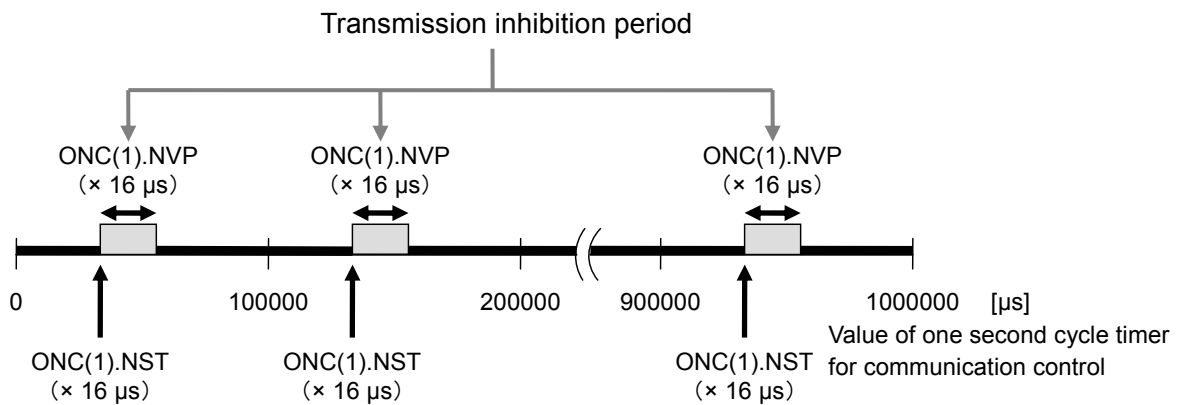

Figure 4-13 Procedures for setting of transmission inhibition period in a mobile station

4.3.5 Logical Link Control sublayer (LLC sublayer)

4.3.5.1 Overview

This section specifies the functions, protocols, and services of the Logical Link Control (LLC) sublayer. The LLC sublayer provides unacknowledged connectionless-mode services (Type 1 operation) to exchange packets between higher layer entities. In addition, the LLC sublayer identifies the higher layer protocol with Subnetwork Access Protocol (SNAP).

The LLC sublayer has the functions as follows:

- Generating the LLC Protocol Data Unit (LPDU)
- Sending and Receiving LPDUs

4.3.5.2 LLC sublayer interface service specifications

The LLC sublayer interface service specifications shall be specified as described in “2.2 Network layer/LLC sublayer interface service specification” of Document [2]. In this system, “Unacknowledged connectionless-mode services” shall be selected.

4.3.5.2.1 Overview of interactions

The overview of interactions shall be specified as described in “2.2.1 Overview of interactions” of Document [2]. In this system, “Unacknowledged connectionless-mode services” shall be selected.

4.3.5.2.2 Service specifications

(1) DL-UNITDATA.request

a) Function

This primitive is the service request primitive for the unacknowledged connectionless-mode service.

b) Semantics of the service primitive

This primitive shall provide parameters as follows:

DL-UNITDATA.request (LinkAddress, data, SequenceNumber,
ControlInformation)

The LinkAddress parameter specifies the destination address. The data parameter specifies the LSDU to be transferred by the data link layer entity. The SequenceNumber parameter specifies the parameter as described in 4.5.2.1.4(1). The ControlInformation parameter specifies the parameter as described in 4.5.2.1.4(2).

c) When generated

This primitive shall be passed from the higher layer entity to the LLC sublayer entity to request that an LSDU is to be transferred.

(2) DL-UNITDATA.indication

a) Function

This primitive is the service indication primitive for the unacknowledged connectionless-mode service.

b) Semantics of the service primitive

This primitive shall provide parameters as follows:

DL-UNITDATA.indication (LinkAddress1, data, length, rxtime, LinkAddress3)

The LinkAddress1, LinkAddress3, and rxtime specify the parameters contained in the MA-UNITDATA.indication received from the MAC sublayer entity. The data parameter specifies the LSDU received by the LLC sublayer. The length parameter specifies the length of the LSDU specified in the data parameter.

c) When generated

This primitive shall be passed from the LLC sublayer entity to the higher layer

entity to indicate the arrival of an LSDU.

4.3.5.3 LLC Protocol Data Unit (PDU)

This section specifies the structure of LLC PDU.

4.3.5.3.1 LLC PDU structure

All LLC PDUs shall conform to the format shown in Figure 4-14.

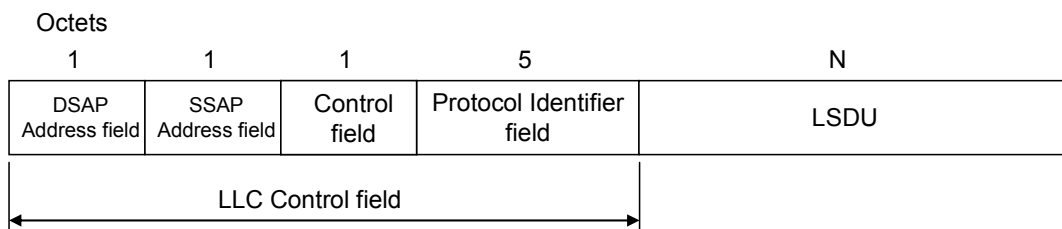

Figure 4-14 LLC PDU format

4.3.5.3.2 Elements of the LLC PDU

(1) Address fields

The address fields shall be specified as described in “3.3.1 Address fields” of Document [2]. The address usage shall be specified as described in “10.3.1 SNAP address” of Document [3]. In this system, the bit pattern “01010101” (starting with LSB, “0xAA” in hexadecimal representation) shall be selected as the Destination Service Access Point (DSAP) and Source Service Access Point (SSAP).

(2) Control field

The control field is specified in 4.3.5.5.1.

(3) Protocol identifier

The protocol identifier is specified in 4.3.5.5.3.

(4) LSDU

The LSDU shall consist of an integral number (including 0) of octets.

(5) Invalid LLC PDU

An invalid LLC PDU shall be specified as one that meets at least one of the following

conditions:

- It is determined to be invalid by Layer 1 or a MAC sublayer.
- Its length is not an integral number of octets.
- Its length is less than 8 octets.
- It contains no valid control fields that are specified in this standard.

Invalid LLC PDUs shall be ignored.

4.3.5.4 LLC types of procedures

The LLC types of procedures shall be specified as described in “4. LLC types and classes of procedures” of Document [2]. In this system, “Type 1 Operation” shall be selected.

4.3.5.5 LLC elements of procedure

This section specifies the elements of the LLC procedures that use the LPDU structure (see 4.3.5.3).

4.3.5.5.1 Control field format

The control field format shall be specified as described in “5.2 Control field formats” of Document [2]. In this system, “Unnumbered format command” shall be selected.

4.3.5.5.2 Command

The command shall be specified as described in “5.4 Commands and responses” of Document [2]. In this system, “Unnumbered information (UI) command” of “Type1 operation commands” shall be selected and the bit pattern “01010101” (starting with LSB, “0xAA” in hexadecimal representation) shall be selected as DSAP (Destination Service Access Point) and SSAP (Source Service Access Point).

4.3.5.5.3 Protocol identifier format

The protocol identifier format shall be specified as described in “9.3 Protocol identifiers” of Document [3].

4.3.5.6 LLC procedures

4.3.5.6.1 Procedure for addressing

The procedure for addressing shall be specified as described in “6.2 Procedure for addressing” of Document [2]. Address usage for DSAP and SSAP shall be specified as described in “10.3.1 SNAP address” of Document [3]. In this system, the bit pattern “01010101” (starting with LSB,

0xAA in hexadecimal representation) shall be selected.

4.3.5.6.2 Procedure for the use of the P bit

The procedure for the use of the P bit shall be specified as described in “6.3 Procedure for the use of the P/F bit” of Document [2]. In this system, “UI command” shall be selected.

4.3.5.6.3 Procedure for the use of protocol identifier

The structure of the protocol identifier is shown in 0. In the first 24 bits (Octet 0 to Octet 2), the LSB (Bit 0) of Octet 0 is reserved and shall be set to 1, Bit 1 of Octet 0 shall be set to 1, and the remaining bits are reserved and shall be set to 0. The remaining 16 bits (Octet 3 and Octet 4) represent the higher layer protocol and shall be specified as shown in 0.

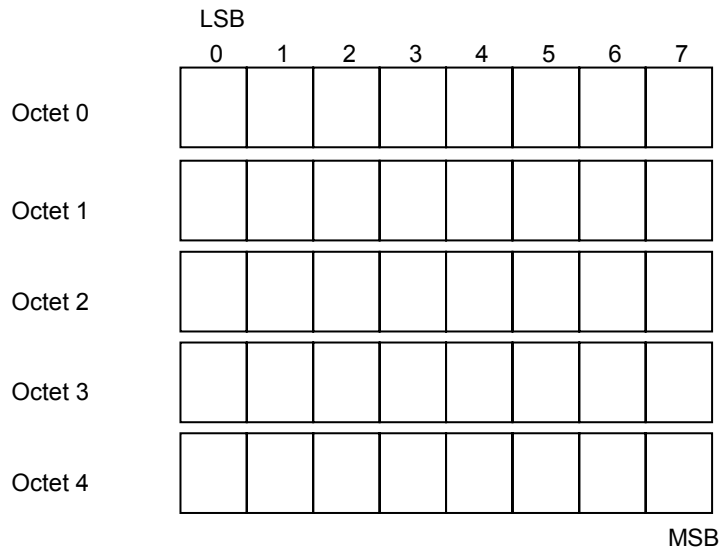

Octets 3 and 4	Meaning
0x0000	Reserved
0x0001	Inter-vehicle Communication and Roadside-to-vehicle Communication Control Layer (IVC-RVC Layer)
0x0002 - 0xFFFF	Reserved

Figure 4-15 Protocol identifier

4.3.5.6.4 Procedure of information transfer

(1) Sending UI PDUs

The sending UI PDUs shall be specified as described in “6.5.1 Sending UI PDUs” of

Document [2].

(2) Receiving UI PDUs

The receiving UI PDUs shall be specified as described in “6.5.2 Receiving UI PDUs” of Document [2].

4.3.5.6.5 List of logical data link parameters

(1) Maximum number of octets in a UI PDU

No restriction is imposed in the LLC sublayer.

(2) Minimum number of octets in a UI PDU

The minimum length valid PDU shall contain two SAP address fields, one control field and one SNAP header.

4.3.6 Layer 2 layer management service interface

4.3.6.1 Overview of interactions between primitives

The Layer 2 layer management entity (MAC sublayer management entity (MLME)) provides the following primitives to the IVC-RVC Layer, Layer 7 or the system management.

MLME_GET.request

MLME_GET.confirm

MLME_SET.request

MLME_SET.confirm

The management information specific to Layer 2 is represented as a Layer 2 MIB. The MLME_GET.request primitive is passed from the IVC-RVC Layer or the system management to MLME to request the getting of the value of the MIB attribute. The MLME_GET.confirm is passed from the MLME to the IVC-RVC Layer or the system management to convey the results of the previous action associated with the MLME_GET.request primitive. The MLME_SET.request primitive is passed from the IVC-RVC Layer or the system management to MLME to request the setting of the value of the MIB attribute. The MLME_SET.confirm is passed from the MLME to the IVC-RVC Layer or the system management to convey the results of the previous action associated with the MLME_SET.request primitive. Details of the variable definition of Layer 2 MIB are specified in Annex 1.

4.3.6.2 Specification of service

(1) MLME_GET.request

a) Function

This primitive is to request the MIB access service.

b) Semantics of service primitive

The primitive parameters shall be as follows:

MLME_GET.request (MIB_attribute)

The “MIB_attribute” parameter is specific to the attribute of the MIB.

c) When generated

This primitive is generated by the IVC-RVC entity or the system management entity to request the getting of the MIB attribute of the MLME and is passed to the MLME.

(2) MLME_GET.confirm

a) Function

This primitive is to report the results of the action associated with the MLME_GET.request.

b) Semantics of service primitive

The primitive parameters shall be as follows:

MLME_GET.confirm (status, MIB_attribute, MIB_attribute_value)

The “status” parameter indicates the success or the failure of the MIB_attribute reading requests. The “MIB_attribute” parameter specifies the attribute provided by the MLME_GET.request. The “MIB_attribute_value” specifies the value of the attribute itself.

c) When generated

This primitive is generated by the MLME to report the results of the previous action provided by the MLME_SET.request primitives and is passed to the IVC-RVC entity or the system management entity.

(3) MLME_SET.request

a) Function

This primitive is to request the MIB access service.

b) Semantics of service primitive

The primitive parameters shall be as follows:

MLME_SET.request (MIB_attribute, MIB_attribute_value)

The “MIB_attribute” parameter specifies the attribute of the MIB. The “MIB_attribute_value” specifies the value.

c) When generated

This primitive is generated by the IVC-RVC entity or the system management entity to request writing the MIB attribute of the MLME and is passed to the MLME.

(4) MLME_SET.confirm

a) Function

This primitive is to report the results of the action provided by the MLME_SET.request.

b) Semantics of service primitive

The primitive parameters shall be as follows:

MLME_SET.confirm (status, MIB_attribute)

The “status” parameter indicates the success or failure of the setting MIB_attribute request provided by MLME_SET.request. The “MIB_attribute” parameter specifies the attribute provided by MLME_SET.request.

c) When generated

This primitive is generated by the MLME to report the results of the previous action provided by the MLME_SET.request primitives and is passed to the IVC-RVC entity or the system management entity.

4.4 Inter-vehicle Communication and Roadside-to-vehicle Communication Control Layer (IVC-RVC Layer) standards

4.4.1 Overview

The IVC-RVC Layer generates and maintains information in order to divide time into inter-vehicle communication periods and roadside-to-vehicle communication periods and prevent interference between an inter-vehicle communication and a roadside-to-vehicle communication. In this standard, “inter-vehicle communication” means a communication between mobile stations, and “roadside-to-vehicle communication” means a communication between a base station and a mobile station.

4.4.1.1 General

Base stations and mobile stations carry out communications normally in a cycle of 100 ms. A base station transfers the transmission timestamp and the roadside-to-vehicle communication (RVC) period information (including the transfer count and the duration of the RVC period) to surrounding mobile stations, so that it acquires its own communication period. Besides, a base station shall maintain synchronization with the other base stations that is $\pm 16 \mu\text{s}$ or less (an example of the method for time synchronization between base stations is described in Description 2). A mobile station synchronizes its local clock based on the transmission timestamp received from a base station, and inhibits its transmission based on the RVC period information, so that it transmits packets at a time other than transmission periods for base stations. The IVC-RVC Layer plays the role of generating and maintaining the control information, and passing the information that is needed for the transmission control to Layer 2.

The allocation of transmission periods for base stations (RVC periods) is shown in Figure 4-16. The control period is 100 ms and the control time unit is $16 \mu\text{s}$. Therefore, the duration of the control period is 6250 in control time units. The maximum number of RVC periods allocated within the control periods is 16, and the RVC periods shall be allocated every 390 time units ($6240 \mu\text{s}$) from the beginning of the control period. The maximum duration of the RVC period shall be 189 ($3024 \mu\text{s}$) in control time units.

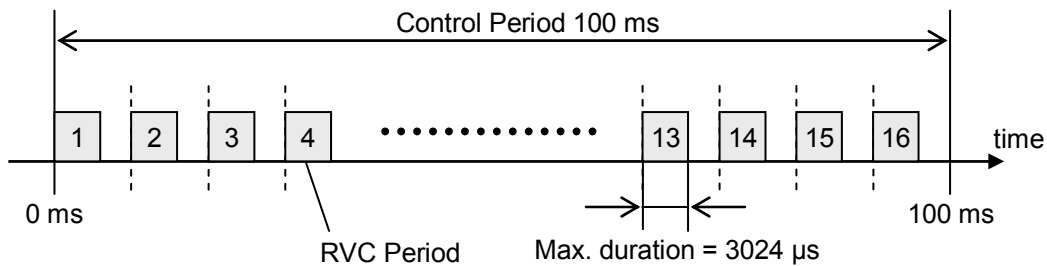

Figure 4-16 Roadside-to-vehicle communication periods

4.4.1.2 Functions

The IVC-RVC Layer maintains the information for IVC-RVC control, and provides the required control parameters to Layer 2. The IVC-RVC Layer mainly provides the services as follows:

(1) Generating IVC-RVC protocol data units (IPDUs)

When transmitting a frame, the IVC-RVC Layer receives an IVC-RVC service data unit (ISDU) from Layer 7, and generates an IVC-RVC protocol data unit (IPDU). The details of the IPDU are specified in 4.4.3.1.

(2) Sending and receiving IPDUs

When transmitting a frame, the IVC-RVC Layer generates an IPDU and requests a transfer of the IPDU to the LLC sublayer. When receiving a frame, the IVC-RVC Layer receives an IPDU (LSDU) from the LLC sublayer and passes the ISDU to Layer 7.

(3) Inter-vehicle Communication and Roadside-to-vehicle Communication Control
(Transmission Inhibition Periods Control)

A base station sets transmission inhibition periods at times other than RVC periods. A mobile station sets transmission inhibition periods at times indicated by a base station. The actual operation for setting the transmission inhibition periods is carried out by the MAC sublayer entity in Layer 2. The IVC-RVC Layer therefore indicates the parameters required for the transmission inhibition period control to Layer 2.

(4) Maintaining Roadside-to-vehicle Communication Period Information

A base station maintains the RVC period information for its own transmission. A mobile station inserts, updates, and deletes RVC period information based on the

information received from a base station or other mobile stations.

4.4.2 IVC-RVC Layer interface service specifications

4.4.2.1 IVC-RVC data service interface

4.4.2.1.1 Overview of interactions

The IVC-RVC Layer provides the following primitives to Layer 7:

IR-UNITDATA.request

IR-UNITDATA.indication

The IR-UNITDATA.request is passed from Layer 7 to the IVC-RVC Layer to request a transfer of an ISDU. The IR-UNITDATA.indication is passed from the IVC-RVC Layer to Layer 7 to indicate the arrival of an ISDU.

4.4.2.1.2 Service specifications

(1) IR-UNITDATA.request

a) Function

This primitive is the service request primitive for requesting the transfer of an ISDU.

b) Semantics of the primitive

This primitive shall provide the parameters as follows:

IR-UNITDATA.request (LinkAddress, data, SequenceNumber,
ControlInformation)

The LinkAddress parameter specifies the destination address. The data parameter specifies the ISDU to be transferred by the IVC-RVC Layer. The SequenceNumber parameter specifies the parameter as described in 4.5.2.1.4(1). The ControlInformation parameter specifies the parameter as described in 4.5.2.1.4(2).

c) When generated

This primitive is always generated by the Layer 7 entity.

(2) IR-UNITDATA.indication

a) Function

This primitive is the transfer primitive of ISDU from the IVC-RVC Layer entity to the Layer 7 entity.

b) Semantics of the primitive

This primitive shall provide the parameters as follows:

IR-UNITDATA.indication (LinkAddress1, data, length, LinkAddress3)

The LinkAddress1 and LinkAddress3 parameters specify the corresponding values that are specified in the associated DL-UNITDATA.indication received from the LLC sublayer. The data parameter specifies the ISDU to be received by Layer 7. The length parameter specifies the length of the ISDU specified in the data parameter.

c) When generated

The IR-UNITDATA.indication is passed from the IVC-RVC Layer to Layer 7 to indicate the arrival of a message.

4.4.2.2 IVC-RVC Layer management service interface

4.4.2.2.1 Overview of interactions

The IVC-RVC Layer Management Entity (IRLME) provides the following primitives to Layer 7 or the System Management Entity (SME). The IRLME_GET.request and the IRLME_GET.confirm are also provided to Layer 2.

IRLME_GET.request

IRLME_GET.confirm

IRLME_SET.request

IRLME_SET.confirm

The IRLME_GET.request is passed from Layer 7, Layer 2, or the SME to the IRLME in order to request the getting of an attribute stored in the Management Information Base (MIB) in the IRLME. The IRLME_GET.confirm is passed from the IRLME to Layer 7, Layer 2, or the SME that issued the associated IRLME_GET.request in order to report the result of getting an MIB attribute. The IRLME_SET.request is passed from Layer 7 or the SME to the IRLME to request the setting of a value to an MIB attribute. The IRLME_SET.confirm is passed from the IRLME to Layer 7 or the SME that issued the associated IRLME_SET.request in order to report the result of setting a value to an MIB attribute.

4.4.2.2.2 Service specifications

(1) IRLME_GET.request

a) Function

This primitive is the service request primitive for the MIB access control service.

b) Semantics of the primitive

This primitive shall provide the parameter as follows:

IRLME_GET.request (MIB_attribute)

The MIB_attribute parameter specifies the name of the MIB attribute.

c) When generated

This primitive is invoked when the getting of an MIB attribute of the IRLME is requested. This primitive is passed from Layer 7, Layer 2, or the SME to the IRLME.

(2) IRLME_GET.confirm

a) Function

This primitive is the service confirmation primitive for the MIB access control service.

b) Semantics of the primitive

This primitive shall provide the parameters as follows:

IRLME_GET.confirm (status, MIB_attribute, MIB_attribute_value)

The status parameter specifies whether getting an MIB attribute by the IRLME_GET.request has succeeded. The MIB_attribute parameter specifies the name of the parameter specified in the associated IRLME_GET.request. The MIB_attribute_value parameter specifies the value of the parameter specified in the associated IRLME_GET.request.

NOTE 1: If an invalid attribute name is specified, status = "error".

NOTE 2: If status = "error", the value of the MIB_attribute_value is not guaranteed.

NOTE 3: MIB_attributes are described in Annex 1.

c) When generated

The IRLME_GET.confirm primitive is invoked when the result of getting an MIB_attribute is indicated. This primitive is passed from the IRLME to Layer 7,

Layer 2, or the SME.

(3) IRLME_SET.request

a) Function

This primitive is the service request primitive for the MIB access control service.

b) Semantics of the primitive

This primitive shall provide the parameters as follows:

IRLME_SET.request (MIB_attribute, MIB_attribute_value)

NOTE: MIB_attributes are described in Annex 1.

c) When generated

This primitive is invoked when an MIB attribute of the IRLME is requested to be set. This primitive is passed from Layer 7 or the SME to the IRLME.

(4) IRLME_SET.confirm

a) Function

This primitive is the service confirmation primitive for the MIB access control service.

b) Semantics of the primitive

This primitive shall provide the parameters as follows:

IRLME_SET.confirm (status, MIB_attribute)

The status parameter specifies whether setting an MIB_attribute by the IRLME_SET.request has succeeded. The MIB_attribute parameter specifies the name of the parameter specified in the associated IRLME_SET.request.

NOTE 1: If an invalid attribute name is specified, status = "error".

NOTE 2: MIB_attributes are described in Annex 1.

c) When generated

The IRLME_SET.confirm primitive is invoked when the result of setting a value to an MIB attribute is indicated. This primitive is passed from the IRLME to Layer 7 or the SME.

4.4.3 Inter-vehicle Communication and Roadside-to-vehicle Communication Control

4.4.3.1 IVC-RVC Protocol Data Unit (PDU)

4.4.3.1.1 IVC-RVC PDU format

The IVC-RVC Layer protocol data unit (IPDU) is comprised of the IR control field and the ISDU, as shown in Figure 4-17. Besides, the first bit of each field shall be MSB and the endianness shall be big-endian, unless otherwise specified.

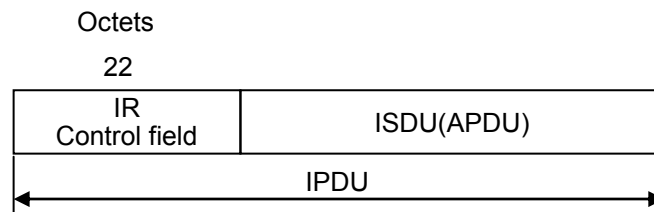

Figure 4-17 IVC-RVC PDU format

4.4.3.1.2 Elements of the IVC-RVC PDU

(1) IR Control field

The IR control field is 22 octets in length, as shown in Figure 4-18.

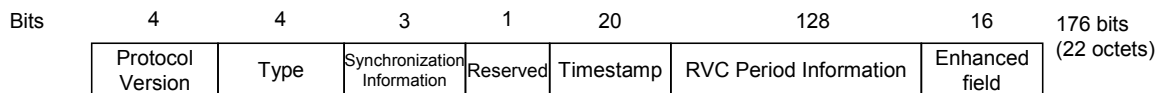

Figure 4-18 IR Control field

a) Protocol Version field

The protocol version field is 4 bits in length, as shown in Figure 4-19. The protocol version shall be set to 0, and the values from 1 to 15 are reserved for future use.

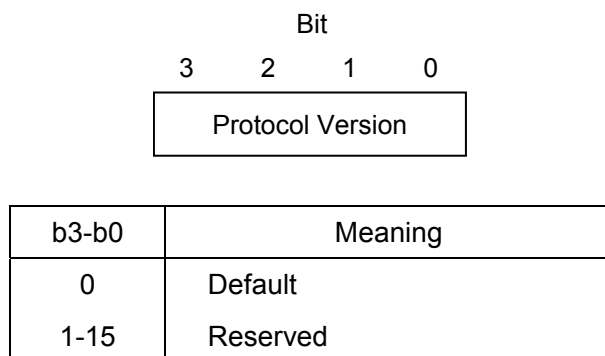

Figure 4-19 Protocol Version field

b) Type field

The type field is 4 bits in length, as shown in Figure 4-20. Bit number 3 (b3) is used to specify the type of source. This bit shall be set to 1 for a base station and 0 for a mobile station. The other bits from bit number 2 to bit number 0 (b2-b0) are reserved for future use and shall be set to 0.

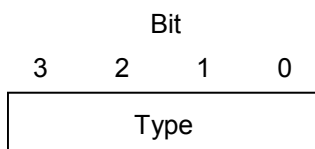

Figure 4-20 Type field

c) Synchronization Information field

This field is 3 bits in length and indicates the synchronization status. The bit 2 (b2) is used to indicate whether a station is synchronized or not. The bit b2=1 means “synchronized” and b2=0 means “unsynchronized”. The bit 1 and bit 0 (b1, b0) are valid only if the sender is a mobile station and the synchronization status is “synchronized” (i.e. b2=1). The meaning of the bits is shown in Figure 4-21. If the sender is a base station, or if the sender is a mobile station and the synchronization status is “unsynchronized” (i.e. b2=0), b1 and b0 shall be set to 0.

Bit
2 1 0
Synchronization Information

b1 b0	Meaning
0 0	Synchronized directly with a base station
0 1	Synchronized by using information that is transferred once by an MS
1 0	Synchronized by using information that is transferred two times by MSs
1 1	Synchronized by using information that is transferred three times by MSs

Figure 4-21 Synchronization Information field

d) Reserved

This field is reserved for future use and shall be set to 0.

e) Timestamp field

The timestamp field is 20 bits in length and represents the transmission time of the frame. This field indicates the value of the one second cycle timer for communication control in microseconds and its range shall be from 0 to 999999. The timestamp shall be set to the value of the one second cycle timer at the time when the beginning of the PLCP preamble is transmitted from the antenna. This shall be performed by the MAC sublayer. The timing of setting the timestamp is specified in the MAC sublayer. The accuracy of the timestamp shall be $\pm 2 \mu\text{s}$ or better. The IVC-RVC Layer sets the value to 0.

f) Roadside-to-vehicle Communication (RVC) Period Information field

The RVC period information field consists of a plurality of 8 bit fields, each of which corresponds to an RVC period and consists of the transmission count of 2 bits and the RVC period duration of 6 bits. Since the number of the RVC periods in a control period is 16, the length of the RVC period information field is 128 bits (16 octets). The RVC period duration represents the length of the RVC period in 3 units (48 μs) or represents that there is no RVC period if it is set to 0. The meanings of the transmission count and the RVC period duration fields are shown in Figure 4-22.

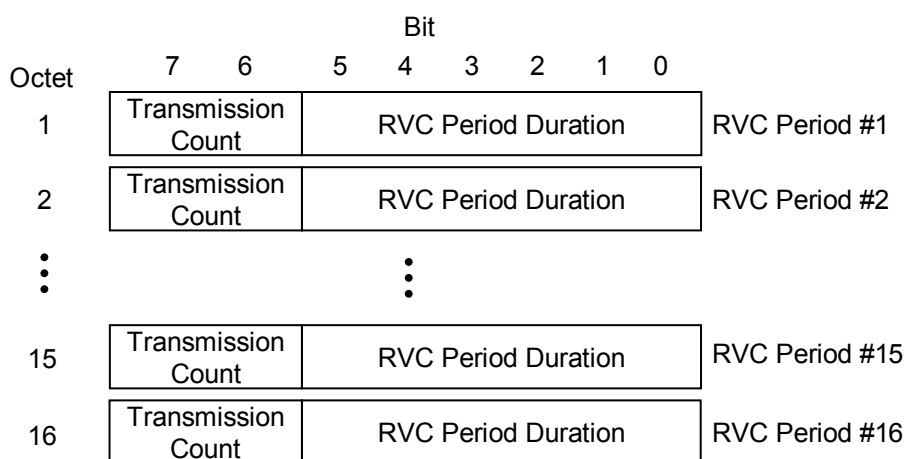

b7 b6	Meaning
0 0	Do not transfer
0 1	Transfer once
1 0	Transfer twice
1 1	Transfer three times

b5-b0	Meaning
0	No RVC Period Information contained
1	RVC Period Duration: 48 μs (3 units)
2	RVC Period Duration: 96 μs (6 units)
:	:
63	RVC Period Duration: 3024 μs (189 units)

Figure 4-22 Roadside-to-vehicle Communication (RVC) Period Information field

g) Enhanced field

This field is reserved for future use and shall be set to 0.

(2) ISDU (APDU) format

The format of the APDU is specified in 4.5.3.1.

4.4.3.2 IVC-RVC elements of procedure

4.4.3.2.1 Base station

(1) RVC Period Information variable (RRC)

The RVC period information variable (RRC) is an array of structures and represents the information of the RVC period. The number of elements is 16. RRC[1] to RRC[16] correspond to the first RVC period to the 16th RVC period, respectively. Each element consists of the transmission count variable “RRC.TRC” and the RVC period duration variable “RRC.RCP”. The range of the value of each variable is specified in 4.4.3.1.2(1)f).

(2) Transmission Control variable (RTC)

The transmission control variable (RTC) is an array of structures and is used for the transmission control. The number of elements is m, where m is implementation dependent and is not specified in this standard. Each element consists of the transmission timing variable “RTC.TST” and the transmission period duration variable “RTC.TRP”. The RTC.TST represents the timing when the transmission begins and is an integer value that is represented in a manner that treats 16 μ s (the control time unit) as 1. The range of the value shall be from 0 to 6249. The RTC.TRP represents the duration of the transmission period and is an integer value that is represented in the same manner as the RTC.TST. The range of the value shall be from 0 to 6250 and the value = 0 indicates that there is no transmission period.

4.4.3.2.2 Mobile station

(1) RVC Period Information Valid Time variable (ORV)

The RVC period information valid time variable (ORV) represents the valid time of the received timestamp and the RVC period information. The value is in milliseconds and the range of the value shall be from 300 to 65535. The received RVC period information is updated every time ORV elapses. The default value shall be 300.

(2) Guard Time (OGT)

The guard time (OGT) represents the time that is added to both ends of the RVC period and is an integer value that is represented in a manner that treats 16 μ s (the control time unit) as 1. The range of the value shall be from 4 to 63 and the default value shall be 4.

(3) RVC Period Information Table (ORT)

The RVC period information table (ORT) is an information table for maintaining the RVC period information and consists of one synchronization information variable “ORT.SYN” and multiple entries of “ORT.ENT”. However, depending on the contents of the received IR control fields, the ORT may have no entry or have a single entry.

The ORT.SYN is a variable of a structure for indicating the synchronization information and consists of the synchronization status variable “ORT.SYN.STA” and the elapsed time variable “ORT.SYN.ELT”. The range and meaning of “ORT.SYN.STA” are specified in 4.4.3.1.2(1)c). The ORT.SYN.ELT represents the elapsed time from updating the ORT.SYN.STA. The range and the unit of the value are not specified in this standard, but it shall clock the ORV.

The ORT.ENT is a variable of a structure for indicating the RVC period information and consists of the RVC period number “ORT.ENT.RCN”, the transmission count “ORT.ENT.TRC”, the RVC period duration “ORT.ENT.RCP”, and the elapsed time “ORT.ENT.ELT”. The ORT.ENT.RCN is an integer and the range of the value shall be from 1 to 16. Each value corresponds to that from the first RVC period to the 16th RVC period, respectively. The range and meaning of the value of the ORT.ENT.TRC and the ORT.ENT.RCP are specified in 4.4.3.1.2(1)f). The range of the value and the unit of the ORT.ENT.ELT are not specified in this standard, but it shall clock the ORV.

Multiple entries with the same RVC period number may register to the ORT.

(4) RVC Period Transmission Information variable (OTI)

The RVC period transmission information variable (OTI) is an array of structures to indicate the RVC period information to be transferred. The number of elements is 16. From OTI[1] to OTI[16] corresponds to that from the first RVC period to the 16th RVC period, respectively. Each element consists of the transmission count “OTI.TRC” and the RVC period duration “OTI.RCP”. The range of the value is specified in 4.4.3.1.2.

(5) Transmission Inhibition Period Control variable (ONC)

The transmission inhibition period control variable (ONC) is an array of structures for the transmission inhibition period control. The number of elements is 16. Each element consists of the transmission inhibition period start timing “ONC.NST” and the transmission inhibition period duration “ONC.NVP”. The ONC.NST represents the time at which the transmission inhibition begins in the control period and is an integer that is represented in the manner that treats 16 μ s (the control time unit) as 1. The range of the

value shall be from 0 to 6249. The `ONC.NVP` represents the duration of a transmission inhibition period and is an integer that is represented in the same manner as `ONC.NST`, which treats 16 μ s (the control time unit) as 1. The range of the value shall be from 0 to 6250 and the value=0 represents that there is no transmission inhibition period.

4.4.3.2.3 Management Information Base (MIB)

The management information base (MIB) is a virtual database in a layer management entity and is constituted by variables such as RRC. The MIB in this layer is not allowed to be accessed directly from all entities except in the IVC-RVC Layer. Besides, an indirect access through an MIB access control service between entities in different management layers is allowed. The MIB attributes are specified in Annex 1.

4.4.3.3 IVC-RVC procedures

The procedures of the IVC-RVC Layer for a base station and a mobile station are specified as follows:

4.4.3.3.1 Base station

(1) Procedures of transmission

a) Generating IPDUs

An IPDU is generated for the ISDU received from Layer 7. The IPDU shall be generated by appending the IR control field specified in 4.4.3.1.2 at the start of the ISDU. The RVC period information field shall be generated by getting the RRC registered in the MIB. The other fields shall be set as specified in 4.4.3.1.2.

b) Requesting a transfer of IPDU to LLC sublayer

After generating an IPDU, the IVC-RVC Layer entity calls the `DL-UNITDATA.request` primitive in the LLC sublayer to request a transfer of the IPDU. At this time, the IVC-RVC Layer shall transfer the “LinkAddress”, “SequenceNumber”, and “ControlInformation” parameters received from Layer 7 to the LLC sublayer with the IPDU.

(2) Procedures of reception

a) Receiving IPDUs

An IPDU is received from the LLC sublayer by the `DL-UNITDATA.indication` primitive. If an IPDU the length of which is less than 22 octets is received, the IPDU shall be discarded and the subsequent procedure shall be cancelled.

b) Dividing the IR control field

An ISDU shall be extracted from the IPDU received from the LLC sublayer by dividing the IR control field from the IPDU.

c) Indicating a reception of IPDU in Layer 7

The reception of an ISDU is indicated in Layer 7 by the IR-UNITDATA.indication primitive. At this time, the length of the ISDU and the LinkAddress1 and LinkAddress3 parameters received from the LLC sublayer are passed to Layer 7 with the ISDU.

(3) Procedure of setting the RVC Period Information variable

A base station shall set the RVC period information "RRC" to the MIB constituted in advance by using the MIB access control service.

(4) Procedure of setting the Transmission Timing and Transmission Period Duration variables

A base station shall set the RTC to the MIB constituted in advance by using the MIB access control service.

4.4.3.3.2 Mobile station

(1) Procedure of transmission

a) Generating IPDUs

An IPDU is generated for the ISDU received from Layer 7. The IPDU shall be generated by appending the IR control field specified in 4.4.3.1.2 at the start of the ISDU. The synchronization information field shall be generated by getting the ORT.SYN.STA, and the RVC period information field shall be generated by getting the OTI. The other fields shall be set as specified in 4.4.3.1.2.

b) Requesting a transfer of IPDU to LLC sublayer

After generating the IPDU, the IVC-RVC Layer entity issues the DL-UNITDATA.request primitive in the LLC sublayer and indicates the transmission request to the LLC sublayer. At this time, the LinkAddress and the SequenceNumber parameters received from Layer 7 shall be passed to the LLC sublayer with the IPDU.

(2) Procedure of reception

a) Receiving IPDUs

An IPDU is received from the LLC sublayer by the DL-UNITDATA.indication primitive. If an IPDU the length of which is less than 22 octets is received, the IPDU shall be discarded and the subsequent procedure shall be cancelled.

b) Extracting IPDUs and transferring IR Control fields to the IVC-RVC Layer Management Entity

An ISDU is extracted from the IPDU received from the LLC sublayer by dividing the IR control field from the IPDU. The IR control field and the rxtime parameter received from the LLC sublayer shall be passed to the IRLME.

c) Indicating a reception of IPDU in Layer 7

The reception of an ISDU is indicated in Layer 7 by the IR-UNITDATA.indication primitive. At this time, the ISDU length, the LinkAddress1 and the LinkAddress3 parameters received from the LLC sublayer shall be passed to Layer 7 with the ISDU.

(3) Procedures of updating the RVC Period Information table (ORT) in the case of receiving an IR Control field

The validity of the received IR control field shall be checked and the ORT shall be updated if the IR control field is determined to be valid. The IR control field shall be determined to be invalid if it meets at least one of the following conditions:

- One of the values in the IR control field is outside the range specified in 4.4.3.1.2.
- The bit 2 of the synchronization information is set to 0 or the bits 1 and 0 are set to "11".
- The value of the RVC period duration in the RVC period information is set to 0.

If the received IR control field is valid, the ORT.SYN and the ORT.ENT shall be updated according to the following procedures:

a) Procedure of updating the Synchronization Information variable (ORT.SYN)

When the IR control field is received from a base station, the ORT.SYN.STA shall be set to 4 (100b).

When the IR control field is received from a mobile station, if the ORT.SYN.STA is 0 (000b), then the ORT.SYN.STA shall be set to the value that is derived by adding 1 to the value of the synchronization information in the received IR control field. If the

ORT.SYN.STA is other than 0(000b), then the value of the synchronization information in the received IR control field shall be compared with the ORT.SYN.STA. If the ORT.SYN.STA is larger than the value of the synchronization information, then the ORT.SYN.STA shall be set to the value that is derived by adding 1 to the value of the synchronization information in the received IR control field.

If the ORT.SYN.STA is updated, the ORT.SYN.ELT shall be set to 0 to reset the elapsed time.

b) Procedure of updating the RVC Period Information Entries (ORT.ENT)

The ORT.ENT shall be updated using the RVC period information the duration of which is not 0 in the received IR control field. If there is no entry in ORT.ENT that has the same RVC period number “ORT.ENT.RCN” as that of the received RVC period information, the received RVC period information is added to the ORT as a new entry. At that time, the ORT.ENT.ELT of the entry shall be set to 0. Otherwise, the ORT.ENT shall be updated according to the following conditions:

- If there is no entry in ORT.ENT that has the same RVC period duration as that of the received RVC period information, the received RVC period information shall be added to the ORT as a new entry. The ORT.ENT.ELT of the entry shall be set to 0.
- Otherwise, the transmission count of the received RVC period information is compared with the ORT.ENT.TRC. If the transmission count of the received RVC period information is larger than the ORT.ENT.TRC, the ORT.ENT.TRC shall be updated to the transmission count of the received RVC period information and the ORT.ENT.ELT shall be set to 0. If the transmission count of the received RVC period information is the same as the ORT.ENT.TRC, only the ORT.ENT.ELT shall be set to 0.

(4) Procedures of periodically updating the RVC Period Information table (ORT)

Each element of ORT has variables that indicate the elapsed time (ORT.SYN.ELT, ORT.ENT.ELT). These elapsed times are updated by IRLME and once one of the elapsed times exceeds the ORV, the corresponding ORT.SYN or ORT.ENT shall be updated according to the procedures specified below. The interval of updating the elapsed times is not specified in this standard.

a) Procedure of updating the Synchronization Information variable (ORT.SYN)

If the ORT.SYN.STA is 0 (“unsynchronized”), no operation shall be carried out. If it is from 4 to 6, the ORT.SYN.STA shall be incremented by 1 and ORT.SYN.ELT shall be set to 0 every time the ORT.SYN.ELT exceeds the ORV. If it is 7, the ORT.SYN.STA shall be set to 0 and all the entries in ORT shall be deleted.

b) Procedure of updating the RVC Period Information Entries (ORT.ENT)

Each entry is updated as follows: If the ORT.ENT.TRC is 1 or larger, the ORT.ENT.TRC shall be decremented by 1 and the ORT.ENT.ELT shall be set to 0 every time the ORT.ENT.ELT exceeds the ORV. If the ORT.ENT.TRC is 0, the entry shall be deleted.

(5) Procedure of synchronization

If the ORT.SYN was updated after receiving an IR control field, the local clock shall be synchronized by compensating the timer in the LME of Layer 2. The compensation shall be carried out by calculating the difference between the timestamp of the received IR control field and the rxtime parameter received by the LLC sublayer, and setting the difference to the MIB attribute TC. The difference between the timestamp of the received IR control field and the value of the one second cycle timer for communication control just after the synchronization shall be $\pm 4 \mu\text{s}$ or less.

(6) Procedure of updating the RVC Period Transmission Information variable (OTI)

If the ORT was updated, the OTI is updated by referencing the ORT. The OTI[n] shall be updated by an entry that has the largest ORT.ENT.TRC among the entries the ORT.ENT.RCN of which is “n”. If the ORT.ENT.TRC is 1 or larger, the OTI[n].TRC shall be set to ORT.ENT.TRC-1 and the OTI[n].RCP shall be set to ORT.ENT.RCP. If the ORT.ENT.TRC is equal to 0, both OTI[n].TRC and OTI[n].RCP shall be set to 0. If there are multiple entries that have the largest ORT.ENT.TRC, the OTI[n].RCP shall be set to the largest ORT.ENT.RCP among those entries. If there is no entry ORT.ENT.RCN of which is “n”, the OTI[n].TRC and the OTI[n].RTP shall be set to 0.

(7) Procedure of updating the Transmission Inhibition Period Control variable (ONC)

If the ORT was updated, the ONC is updated by referencing the ORT. The ONC[n] shall be updated by an entry that has the largest ORT.ENT.RCP among the entries the ORT.ENT.RCN of which is “n”. The ONC[n].NST shall be set to the value that is derived

by subtracting the OGT and a unit number that is equivalent to the duration of a PPDU to be transmitted from the start timing of the RVC period corresponding to the entry. If the updated value is a negative number, 6250 shall be added to the derived value. The $ONC[n].NVP$ shall be set to the value that is a unit number corresponding to the entry plus three times the $ORT.ENT.RCP$ and twice the OGT. If the derived value is larger than 6250, the $ONC.NVP$ shall be set to 6250.

4.5 Layer 7 standards

4.5.1 Scope

This section specifies the architecture and service items of Layer 7.

The purpose of Layer 7 is to provide communication tools for the application whilst the scope of the application oriented working groups is to build the application using the tools provided by Layer 7.

The operation regarding the application service data unit (ASDU) is performed by the invocation from service primitives (SP).

The following subjects are covered by this standard:

- Layer 7 structure and framework.
- Services to enable data transfer and remote operations.
- Common encoding rules to translate data in local syntax with an abstract syntax defined by Abstract Syntax Notation One (ASN.1) into transfer syntax and vice versa (Annex 2).

This standard does not cover the fragmentation procedure, defragmentation procedure, transmission repetition procedure, etc., which are supposed to be performed by the application.

4.5.1.1 Structure

The Figure 4-23 shows the Layer 7 structure and service access points.

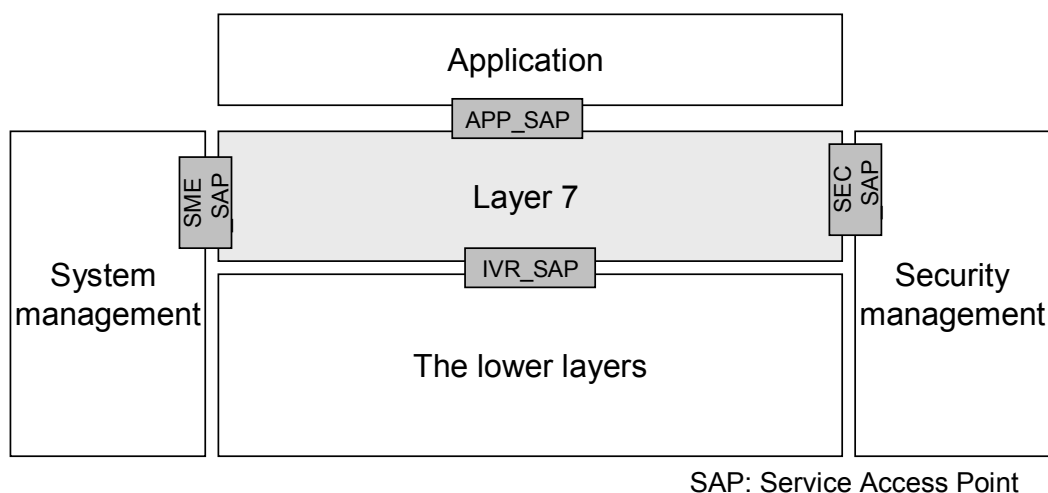

Figure 4-23 Layer 7 structure and service access points

Layer 7 provides the data transmission service to the application through the Application Service Access Point (APP_SAP). If needed, Layer 7 may exchange information with the system management entity and the security management entity through the System Management Service Access Point (SME_SAP) and the Security Management Service Access Point (SEC_SAP), and then pass the transmission request to the lower layer through the Inter-Vehicle and Roadside-to-Vehicle Service Access Point (IVR_SAP).

The above services are provided to service users by service primitives.

4.5.2 Layer 7 service interface

4.5.2.1 Layer 7 data service interface

4.5.2.1.1 General description

Data communication between Layer 7 and the application is performed by the primitive provided by Layer 7.

4.5.2.1.2 Relationship of primitives

There are two kinds of primitives specified in this section as follows:

- The primitives between the application and Layer 7
- The primitives between Layer 7 and the security management entity

Figure 4-24 shows the type and the relationship between these primitives.

a) Request

The request primitive is passed from the application to Layer 7, or Layer 7 to the security management entity to request a service.

b) Indication

The indication primitive is passed from Layer 7 to the application to indicate a service came from another station.

c) Response

The response primitive is passed from the security management entity to Layer 7 to send a response with processing results.

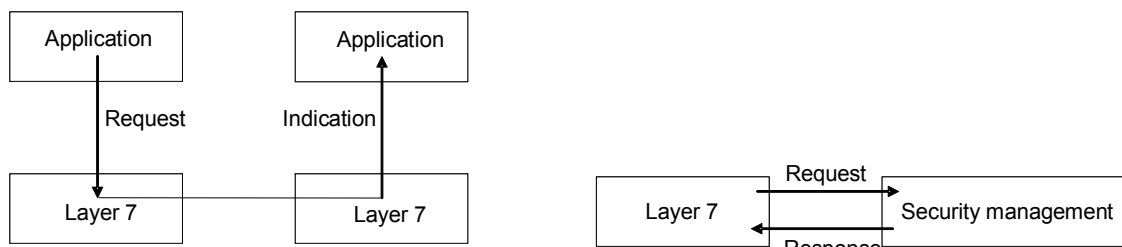

(1) Primitives between the application and layer 7

(2) Primitives between layer 7 and security management

Figure 4-24 Relationship between primitives and entities

4.5.2.1.3 Service specification

(1) MobileStationBroadcastData primitive

a) Function

The MobileStationBroadcastData primitive is used for a mobile station to request a broadcast data transmission, or to receive a broadcast data transmission.

b) Format

The format is as below.

MobileStationBroadcastData.request (ControlInformation, SecurityClassification, SecurityInformation, ApplicationAssociatedInformation, ApplicationDataLength, ApplicationData, LinkAddress)

MobileStationBroadcastData.indication (SecurityClassification, SecurityInformation, ApplicationAssociatedInformation, ApplicationDataLength, ApplicationData, LinkAddress)

(2) BaseStationBroadcastData primitive

a) Function

The BaseStationBroadcastData primitive is used for a base station to request a broadcast data transmission, or to receive a broadcast data transmission.

b) Format

The format is as below.

BaseStationBroadcastData.request (SequenceNumber, ControlInformation, SecurityClassification, SecurityInformation, ApplicationAssociatedInformation, ApplicationDataLength, ApplicationData, LinkAddress)

BaseStationBroadcastData.indication (SecurityClassification,

SecurityInformation, ApplicationAssociatedInformation, ApplicationDataLength, ApplicationData, LinkAddress)

(3) Security primitive

a) Function

The security primitive is used for Layer 7 to transfer the application data to the security management entity to perform the digital signature and/or the encryption processes and receive the results from the security management entity. The security primitive will not be invoked by the application directly and is invoked by the MobileStationBroadcastData.request or BaseStationBroadcastData.request.

b) Format

The format is as below.

Security.request (SecurityInformation, ApplicationAssociatedInformation, ApplicationDataLength, ApplicationData)

Security.response (ApplicationDataLength, SecureApplicationData)

(4) Unsecurity primitive

a) Function

The unsecurity primitive is used for Layer 7 to transfer the received application data to the security management entity to perform the signature verification and/or the decryption processes and receive the results from the security management entity. The security primitive will not be invoked by the application directly and is invoked by the MobileStationBroadcastData.indication or BaseStationBroadcastData.indication.

b) Format

The format is as below.

Unsecurity.request (ApplicationAssociatedInformation, ApplicationDataLength, SecureApplicationData)

Unsecurity.response (SecurityInformation, ApplicationDataLength, ApplicationData)

4.5.2.1.4 Parameters

The parameters described in primitives in 4.5.2.1.3 shall be specified as below. Unless a

modification is notified, it is assumed that the first bit is MSB and the endian is big-endian.

(1) SequenceNumber

SequenceNumber shows the total number and the sequence of the packets generated by the application each time. The format of SequenceNumber is shown in Figure 4-25.

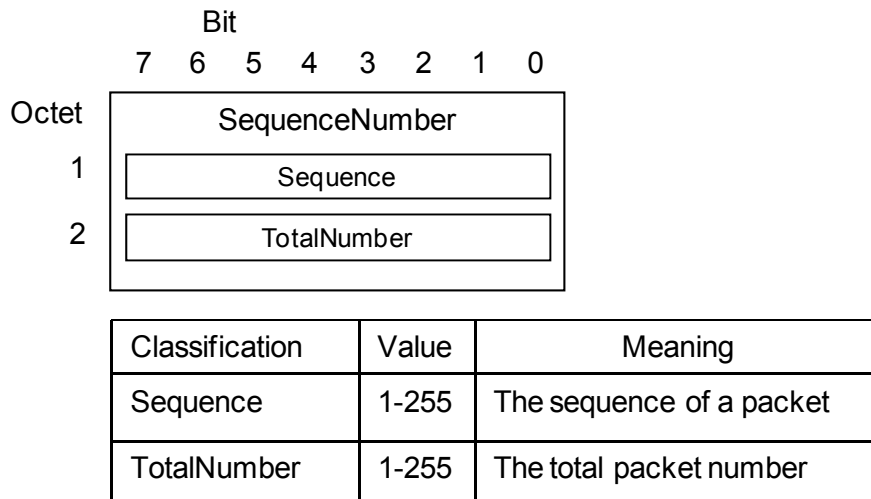

Figure 4-25 The format of SequenceNumber

(2) ControlInformation

ControlInformation shows the control information of radio communication, which is passed from the application to Layer 7. The format of ControlInformation is shown in Figure 4-26.

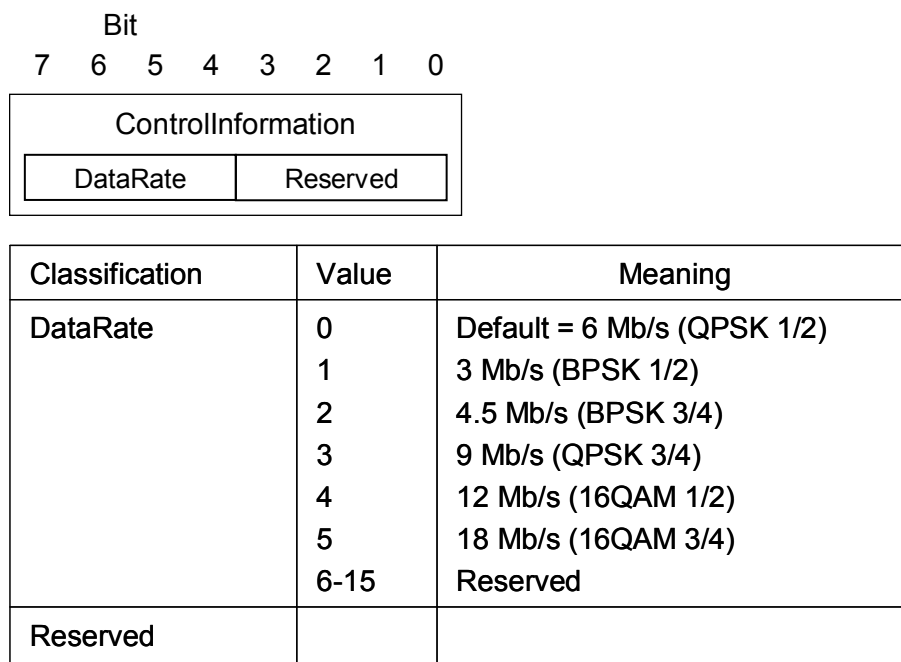

Figure 4-26 The format of ControlInformation

(3) SecurityClassification

SecurityClassification shows the security classification information, which is passed from the application to Layer 7. The format of SecurityClassification is shown in Figure 4-27.

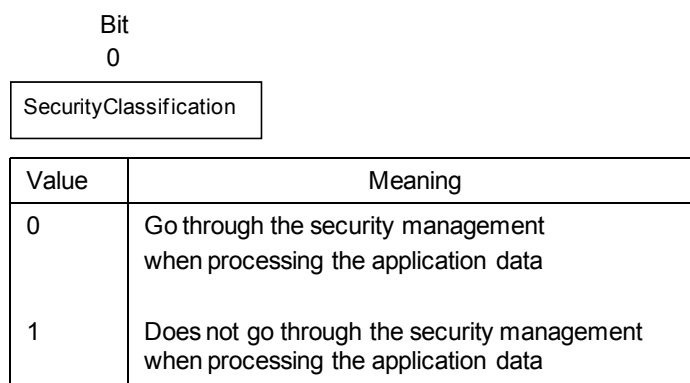

Figure 4-27 The format of SecurityClassification

(4) SecurityInformation

SecurityInformation shows the security related information, which is passed from the application to Layer 7 on the transmitting side or from Layer 7 to the application on the receiving side.

In addition, on the transmitting side if the above SecurityClassification is “1”, Layer 7 treats SecurityInformation as valid information and shall pass it to the security management entity. If the above SecurityClassification is “0”, Layer 7 treats SecurityInformation as invalid information. Likewise on the receiving side if the above SecurityClassification is “1”, the application treats SecurityInformation as valid information. If the above SecurityClassification is “0”, the application treats SecurityInformation as invalid information.

The format of SecurityInformation is shown in Figure 4-28.

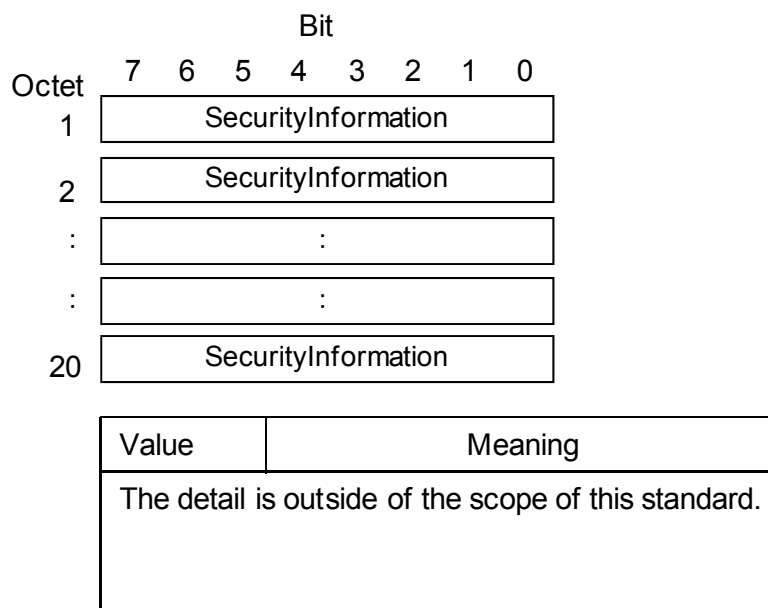

Figure 4-28 The format of SecurityInformation

(5) ApplicationAssociatedInformation

ApplicationAssociatedInformation shows the application related information, which is passed from the application to Layer 7 on the transmitting side or from Layer 7 to the application on the receiving side.

The format of ApplicationAssociatedInformation is shown in Figure 4-29.

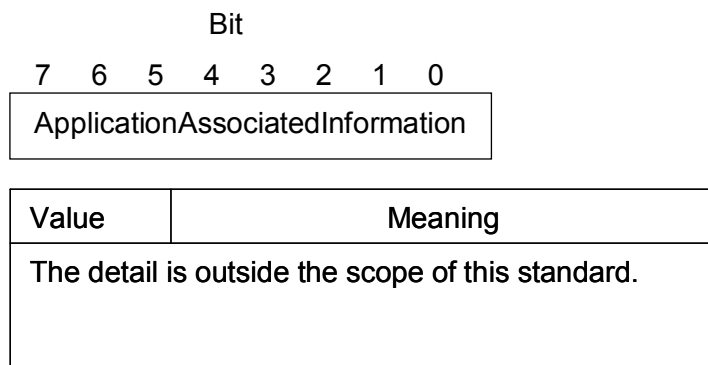

Figure 4-29 The format of ApplicationAssociatedInformation

(6) ApplicationDataLength

ApplicationDataLength shows the length of the application data. ApplicationDataLength is exchanged between the application and Layer 7, or between Layer 7 and the security management entity, or between Layer 7 and the IVC-RVC Layer.

The format of ApplicationDataLength is shown in Figure 4-30.

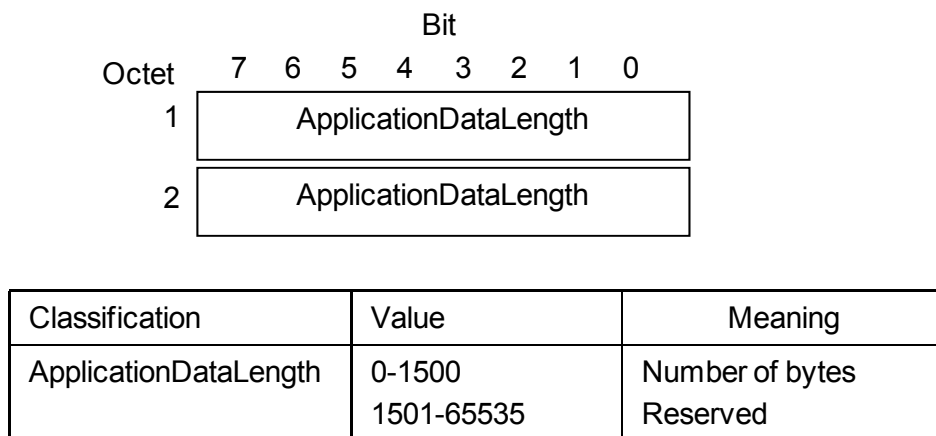

Figure 4-30 The format of ApplicationDataLength

(7) ApplicationData

ApplicationData shows the application data, which is passed from the application to Layer 7 on the transmitting side or from Layer 7 to the application on the receiving side.

The format of ApplicationData is shown in Figure 4-31.

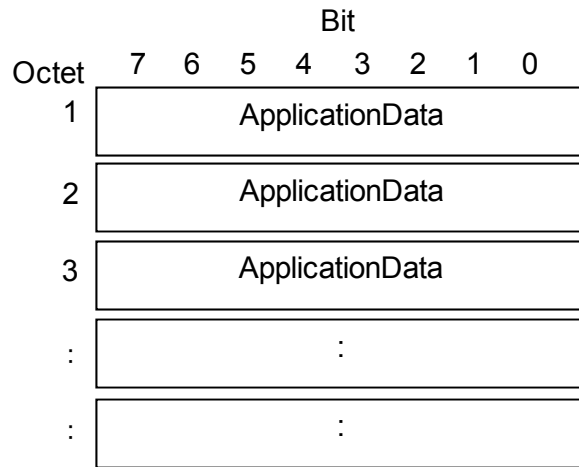

Figure 4-31 The format of ApplicationData

(8) SecureApplicationData

SecureApplicationData shows the digitally-signed or encrypted application data, which is passed from the security management entity to Layer 7 on the transmitting side, or shows the verified or decrypted application data, which is passed from the security management entity to Layer 7 on the receiving side.

The format of SecureApplicationData is shown in Figure 4-32.

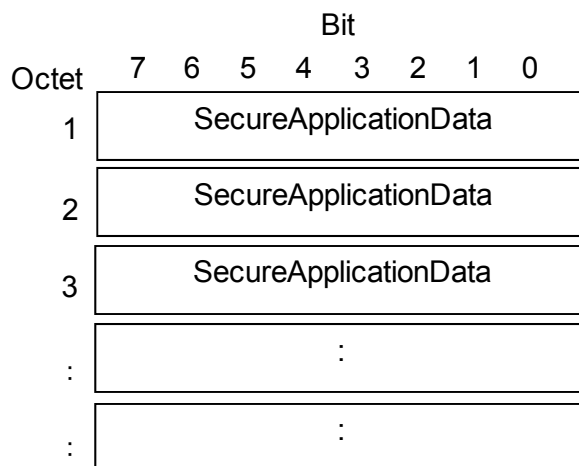

Figure 4-32 The format of SecureApplicationData

(9) LinkAddress

LinkAddress shows the destination address on the transmitting side, which is passed from the application to Layer 7, or shows the identification code of the transmitter on the receiving side, which is passed from Layer 7 to the application.

In the case of the destination address passed from the application to Layer 7, “LinkAddress” shall be set as a destination address specified in MAC’s control field, which is specified in 4.3.2.1. “LinkAddress” shall be passed from Layer 7 to the IVC-RVC Layer through IR-UNITDATA.request primitive.

In the case of the identification code passed from Layer 7 to the application, “LinkAddress” shall be set as an identification code specified in MAC’s control field. “LinkAddress” shall be passed from the IVC-RVC Layer to Layer 7 through IR-UNITDATA.indication primitive and shall be passed to the application.

4.5.2.1.5 Procedures (Sequences)

One procedure shall be selected depending on the value of “SecurityClassification”. If “SecurityClassification” is “0”, the procedure shown in Figure 4-33 shall be selected. If “SecurityClassification” is “1”, the procedure shown in Figure 4-34 shall be selected.

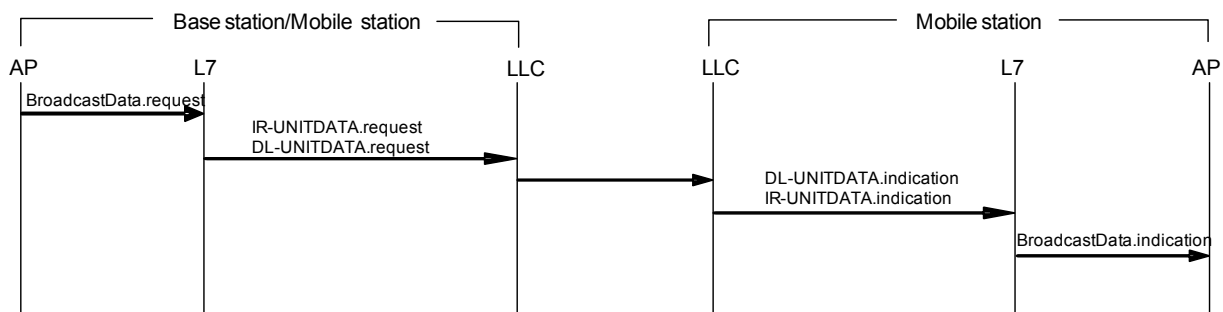

Figure 4-33 The procedure without the pass of the security management entity

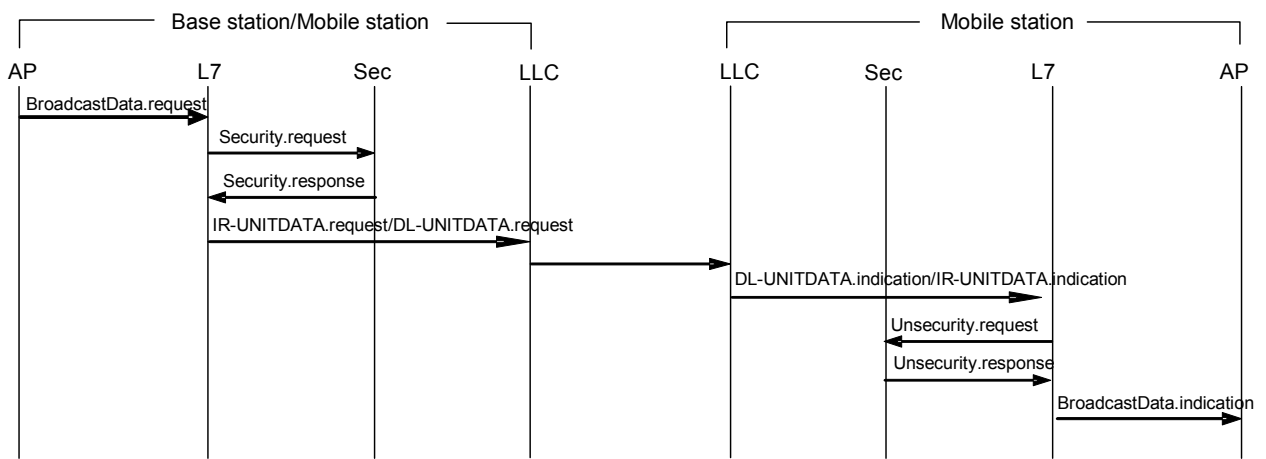

Figure 4-34 The procedure with the pass of the security management entity

4.5.2.2 Layer 7 management service interface specification

4.5.2.2.1 Overview

The Layer 7 management entity (ALME: Application Layer Management Entity) consists of a communication parameter list, other necessary information for communication management, and the functions accessing this information.

The communication parameter list and management information are stored in the Management Information Base (MIB). The details of MIB related to the Layer 7 management entity are specified in Annex 1.

4.5.2.2.2 Relationship of primitives

The Layer 7 management entity provides the following primitives for the system management entity.

ALME_GET.request

ALME_GET.confirm

ALME_SET.request

ALME_SET.confirm

The ALME_GET.request primitive is passed from the system management entity to Layer 7 to request readout of a variable stored in MIB. The ALME_GET.confirm primitive is passed from Layer 7 to the system management entity to report the MIB results requested by ALME_GET.request. The ALME_SET.request primitive is passed from the system management entity to Layer 7 to request update of a variable stored in MIB. The ALME_SET.confirm primitive is passed from Layer 7 to the system management entity to send back the status result of the MIB updating requested by the ALME_SET.request.

4.5.2.2.3 Management service specification

This section describes the details of the primitives and the parameters associated with the management services specified in 4.5.2.2.2. The parameters are specified abstractly, focusing on the necessary information on the receiver side. In addition, there is no limitation on the implementation method. The logical relationship of primitives is shown in Figure 4-35.

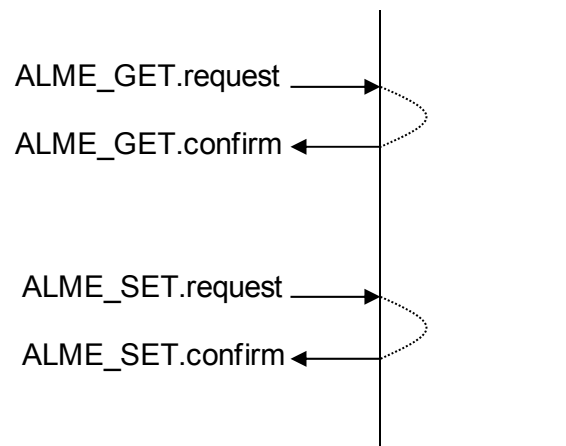

Figure 4-35 The logical relationship of primitives

(1) ALME_GET.request

a) Function

This primitive is used to request a service for Layer 7 management.

b) Semantics of the service primitive

This primitive uses the following parameter:

ALME_GET.request(MIB_attribute)

The name of the MIB variable is supposed to be set as the above “MIB_attribute”.

c) When generated

This primitive is generated by the system management entity to request the getting of an MIB attribute of the ALME, which is passed from the system management entity to Layer 7.

(2) ALME_GET.confirm

a) Function

This primitive is used to report the results associated with the ALME_GET.request.

b) Semantics of the service primitive

This primitive uses the following parameters:

ALME_GET.confirm (status, MIB_attribute, MIB_attribute_value)

The “status” indicates the success or failure of the readout of the MIB_attribute. The “MIB_attribute” is the variable name provided by the ALME_GET.request. The “MIB_attribute_value” is the value of the variable.

c) When generated

This primitive is generated by Layer 7 to report the results associated with the ALME_GET.request, which is passed from Layer 7 to the system management entity.

(3) ALME_SET.request

a) Function

This primitive is used to request a service for Layer 7 management.

b) Semantics of the service primitive

This primitive uses the following parameters:

ALME_SET.request (MIB_attribute, MIB_attribute_value)

The “MIB_attribute” is the MIB variable name. The “MIB_attribute_value” is the value of the variable.

c) When generated

This primitive is generated by the system management entity to request the setting of an MIB attribute of the ALME, which is passed from the system management entity to Layer 7.

(4) ALME_SET.confirm

a) Function

This primitive is used to report the results associated with the LME_SET.request.

b) Semantics of the service primitive

This primitive uses the following parameters:

ALME_SET.confirm (status, MIB_attribute)

The “status” indicates the success or failure of the update of the MIB_attribute. The “MIB_attribute” is the variable name provided by the ALME_SET.request.

c) When generated

This primitive is generated by Layer 7 to report the results associated with ALME_SET.request, which is passed from Layer 7 to the system management entity.

4.5.3 Layer 7 communication control

4.5.3.1 Layer 7 Protocol Data Unit (PDU)

(1) Application Data Unit (ADU)

ADU is the data unit defined in the application, transferred between two application entities.

(2) Application Protocol Data Unit (APDU)

APDU is the data unit transferred between application services.

(3) Application Service Data Unit (ASDU)

ASDU is the data unit associated with application service primitives. The size of an ASDU is from 0 to 1500 octets.

4.5.3.1.1 The format of Layer 7 protocol data unit

The protocol data unit (APDU) of Layer 7 consists of the Layer 7 header and an ASDU as shown in Figure 4-36. Unless a modification is notified, the first bit shall be MSB, and the endian shall be big-endian.

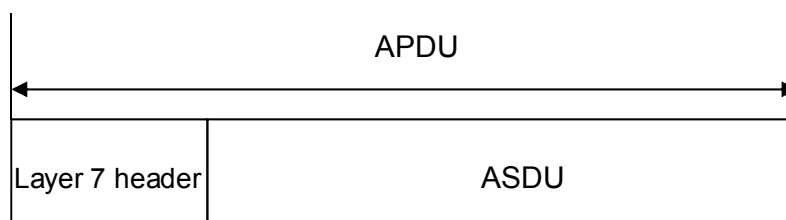

Figure 4-36 The format of Layer 7 PDU

4.5.3.1.2 PDU elements of Layer 7

The size of a Layer 7 header is 2 octets. The format of the Layer 7 header is shown in Figure 4-37.

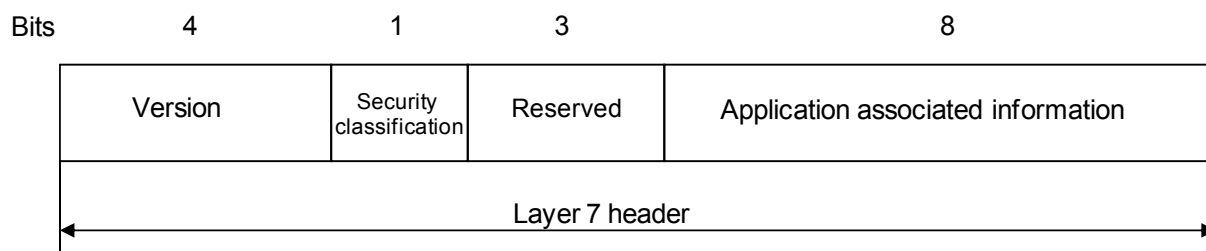

Figure 4-37 The format of the Layer 7 header

(1) Version

Version shows the version information of Layer 7. The format of the version is shown in Figure 4-38.

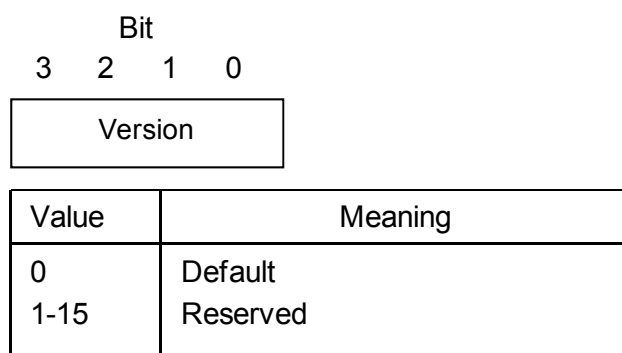

Figure 4-38 The format of the version

(2) Security classification

The details of the security classification are the same as those of the SecurityClassification specified in 4.5.2.1.4(3).

(3) Reserved

The value of the reserved field shall be “0”.

(4) Application associated information

The details of the application associated information are the same as those of the ApplicationAssociatedInformation specified in 4.5.2.1.4(5).

4.5.3.2 Layer 7 procedure

4.5.3.2.1 Base station

(1) Transmitting procedure

a) Generation of APDU

Layer 7 shall generate APDU based on the following data list provided by the application through the BaseStationBroadcastData.request primitive specified in 4.5.2.1.3.

- 1) SequenceNumber
- 2) ControlInformation
- 3) SecurityClassification
- 4) SecurityInformation
- 5) ApplicationAssociatedInformation
- 6) ApplicationDataLength
- 7) ApplicationData
- 8) LinkAddress

There are two different procedures on Layer 7 depending on the value of 3) “SecurityClassification”.

If the “SecurityClassification” is “0”, Layer 7 shall treat 7) “ApplicationData” as an ASDU, and generates the APDU by adding a Layer 7 header specified in 4.5.3.1.2. At the same time, Layer 7 shall assign 3) “SecurityClassification” and 5) “ApplicationAssociatedInformation” as the security classification and the application associated information respectively to the Layer 7 header.

If the “SecurityClassification” is “1”, Layer 7 shall invoke the Security.request primitive, and pass 4) “SecurityInformation”, 5) “ApplicationAssociatedInformation”, 6) “ApplicationDataLength” and 7) “ApplicationData” to the security management entity. Then Layer 7 receives the updated 6) “ApplicationDataLength” and the “SecureApplicationData” from the security management entity through the Security.response primitive. Layer 7 shall treat the “SecureApplicationData” as an ASDU, and generate the APDU by adding a Layer 7 header specified in 4.5.3.1.2. At the same time, Layer 7 shall assign 3) “SecurityClassification” and 5) “ApplicationAssociatedInformation” as the security classification and the application associated information respectively to the Layer 7 header.

b) Generation of transmitting request to the IVC-RVC Layer

After generating the APDU, Layer 7 shall generate the transmitting request to the IVC-RVC by invoking the IR-UNITDATA.request primitive. Layer 7 shall pass the APDU as the “data” parameter of the IR-UNITDATA.request primitive, together with 1) “SequenceNumber”, 2) “ControlInformation”, and 8) “LinkAddress” parameters to the IVC-RVC Layer through the IR-UNITDATA.request primitive.

(2) Receiving procedure

a) Receipt of APDU

Layer 7 shall receive the “LinkAddress1”, the “data”, the “length”, and the “LinkAddress3” from the IVC-RVC Layer through the IR-UNITDATA.indication primitive. Layer 7 shall assign the “data”, the “length”, and the “LinkAddress3” as the APDU, the “ApplicationDataLength” and the “LinkAddress” respectively.

b) Generation of ASDU

Layer 7 shall take out the Layer 7 header from the received APDU, and store the security classification and the application associated information in the “SecurityClassification” parameter and the “ApplicationAssociatedInformation” parameter. There are two different procedures on Layer 7 depending on the value of the “SecurityClassification”.

If the “SecurityClassification” is “0”, Layer 7 shall take out the Layer 7 header from the APDU and treat the remaining part as an ASDU.

If the “SecurityClassification” is “1”, Layer 7 shall take out the Layer 7 header from the APDU, and treat the remaining part as the “SecureApplicationData”. Layer 7 shall invoke the UnSecurity.request primitive specified in 4.5.2.1.3, and pass the “ApplicationAssociatedInformation”, the “ApplicationDataLength”, and the “SecureApplicationData” to the security management entity. Then Layer 7 shall receive the “SecurityInformation”, the updated “ApplicationDataLength” and the “ApplicationData” from the security management entity through the UnSecurity.response primitive. Layer 7 shall treat the “ApplicationData” as an ASDU.

c) Acknowledgment of Receipt of APDU to the application

Layer 7 shall treat the ASDU as the “ApplicationData” parameter, and pass it together with the “SecurityClassification”, the “SecurityInformation”, the

“ApplicationAssociatedInformation”, the “ApplicationDataLength”, and the “LinkAddress” to the application through the BaseStationBroadcastData.indication primitive.

4.5.3.2.2 Mobile Station

(1) Transmitting procedure

a) Generation of APDU

Layer 7 shall generate APDU based on the following data list provided by the application through the MobileStationBroadcastData.request primitive specified in 4.5.2.1.3.

- 1) ControlInformation
- 2) SecurityClassification
- 3) SecurityInformation
- 4) ApplicationAssociatedInformation
- 5) ApplicationDataLength
- 6) ApplicationData
- 7) LinkAddress

There are two different procedures on Layer 7 depending on the value of 2) “SecurityClassification”.

If the “SecurityClassification” is “0”, Layer 7 shall treat 6) “ApplicationData” as an ASDU, and generate the APDU by adding a Layer 7 header specified in 4.5.3.1.2. At the same time, Layer 7 shall assign 2) “SecurityClassification” and 4) “ApplicationAssociatedInformation” as the security classification and the application associated information respectively to the Layer 7 header.

If the “SecurityClassification” is “1”, Layer 7 shall invoke the Security.request primitive, and pass 3) “SecurityInformation”, 4) “ApplicationAssociatedInformation”, 5) “ApplicationDataLength” and 6) “ApplicationData” to the security management entity. Then Layer 7 shall receive the updated 5) “ApplicationDataLength” and the “SecureApplicationData” from the security management entity through the Security.response primitive. Layer 7 shall treat the “SecureApplicationData” as an ASDU, and generate the APDU by adding a Layer 7 header specified in 4.5.3.1.2. At the same time, Layer 7 shall assign 2) “SecurityClassification” and 4) “ApplicationAssociatedInformation” as the security classification and the application associated information respectively to the Layer 7 header.

b) Generation of transmitting request to the IVC-RVC Layer

After generating the APDU, Layer 7 shall generate the transmitting request to the IVC-RVC by invoking the IR-UNITDATA.request primitive. Layer 7 shall treat the APDU as the “data” parameter of the IR-UNITDATA.request primitive, and sets the “Sequence” and the “TotalNumber” of the “SequenceNumber” to “0”, and passes the “data” and the “SequenceNumber” together with 1) “ControlInformation”, and 7) “LinkAddress” parameters to the IVC-RVC Layer through the IR-UNITDATA.request primitive.

(2) Receiving procedure

a) Receipt of APDU

Layer 7 shall receive the “LinkAddress1”, the “data”, the “length”, and the “LinkAddress3” from the IVC-RVC Layer through the IR-UNITDATA.indication primitive. Layer 7 shall assign the “data”, the “length”, and the “LinkAddress3” as the APDU, the “ApplicationDataLength” and the “LinkAddress” respectively.

b) Generation of ASDU

Layer 7 shall take out the Layer 7 header from the received APDU, and store the security classification and the application associated information in the “SecurityClassification” parameter and the “ApplicationAssociatedInformation” parameter. There are two different procedures on Layer 7 depending on the value of the “SecurityClassification”.

If the “SecurityClassification” is “0”, Layer 7 shall take out the Layer 7 header from the APDU and treats the remaining part as an ASDU.

If the “SecurityClassification” is “1”, Layer 7 shall take out the Layer 7 header from the APDU and treats the remaining part as the “SecureApplicationData”. Layer 7 shall invoke the UnSecurity.request primitive specified in 4.5.2.1.3, and pass the “ApplicationAssociatedInformation”, the “ApplicationDataLength”, and the “SecureApplicationData” to the security management entity. Then Layer 7 shall receive the “SecurityInformation”, the updated “ApplicationDataLength” and the “ApplicationData” from the security management entity through the UnSecurity.response primitive. Layer 7 shall treat the “ApplicationData” as an ASDU.

c) Acknowledgment of Receipt of APDU to the application

Layer 7 shall treat the ASDU as the “ApplicationData” parameter, and pass it together with the “SecurityClassification”, the “SecurityInformation”, the “ApplicationAssociatedInformation”, the “ApplicationDataLength”, and the “LinkAddress” to the application through the MobileStationBroadcastData.indication primitive.

4.6 System Management

This standard does not specify the details of the system management.

Empty page

Chapter 5 Measurement Methods

The measurement methods of conformance tests for 3.2 "Technical Requirements for Radio Equipment" are specified in this chapter.

These measurement methods are in conformity with 5.1, 5.2, and 5.3, but other methods may be used as long as the measurement accuracy is maintained.

However, in the case where those measurement methods are recognized by the regulatory authority, the measurement methods shall conform to such recognition, but other methods may be used as long as the measurement accuracy is maintained.

5.1 Transmitter

5.1.1 Frequency tolerance

The measurement method of frequency tolerance is described in the section, "Frequency tolerance" of "TELEC-T257 Characteristic Test Methods for 700 MHz band Intelligent Transport Systems".

5.1.2 Occupied bandwidth

The measurement method of occupied bandwidth is described in the section, "Occupied bandwidth" of "TELEC-T257 Characteristic Test Methods for 700 MHz band Intelligent Transport Systems".

5.1.3 Antenna power tolerance

The measurement method of antenna power tolerance is described in the section, "Antenna power tolerance" of "TELEC-T257 Characteristic Test Methods for 700 MHz band Intelligent Transport Systems".

5.1.4 Permissible values for unwanted emission intensity

The measurement method of permissible values for unwanted emission intensity is described in the section, "Permissible unwanted emission intensity" of "TELEC-T257 Characteristic Test Methods for 700 MHz band Intelligent Transport Systems".

5.1.5 Transmission data rate

The measurement method of the transmission data rate is described in the section, "Transmission data rate" of "TELEC-T257 Characteristic Test Methods for 700 MHz band Intelligent Transport Systems".

5.1.6 Modulation accuracy

The method of measurement conforms to the description below. Other conditions are the same as those specified in 4.2.3.8.3.

(1) Measuring system diagram

Figure 5-1 shows a system diagram for Modulation accuracy measurement.

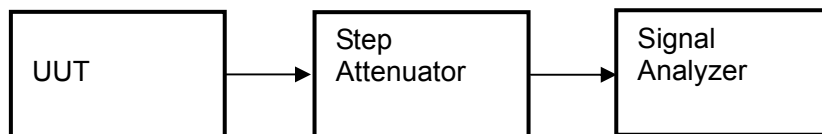

Figure 5-1 Modulation accuracy test system diagram

(2) Conditions for measuring instruments

The signal analyzer is set in modulation accuracy mode, and measures transmitter center frequency leakage, transmitter spectral flatness and transmitter constellation error.

(3) Conditions for unit under test (UUT)

The UUT is the state of the transmitting signal as follows:

- modulation with 511-bit pseudo-random test sequence defined in the ITU-T Recommendation O.150,
- number of OFDM symbols per frame is 16,
- number of frames is 20 or more.

5.2 Receiver

5.2.1 Limit on secondary radiated emissions, etc.

The measurement method of the limit on secondary radiated emissions is described in the section, "Limit on secondary radiated emissions" of "TELEC-T257 Characteristic Test Methods on 700 MHz band Intelligent Transport Systems".

5.2.2 Reception sensitivity

The method of measurement conforms to the method specified in 5.2.2.1.

5.2.2.1 Packet error rate measurement

(1) Measuring system diagram

Figure 5-2 shows a system diagram for Packet error rate measurement.

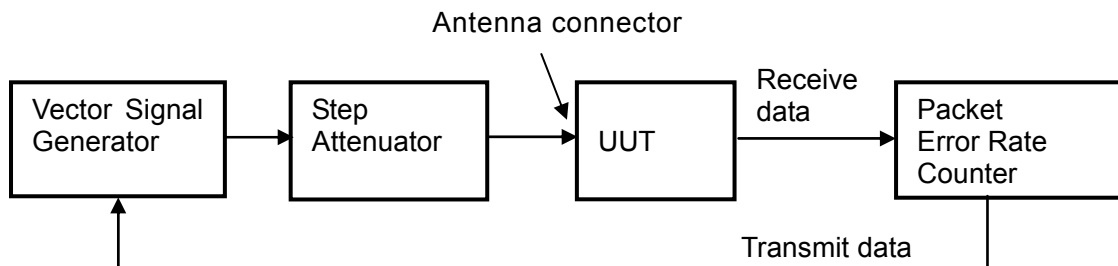

Figure 5-2 Packet error rate measurement system diagram

(2) Conditions for measuring instruments

The signal generated by the vector signal generator conforms to the signal specified in 4.2, and is configured as the parameter below.

Frequency:	760 MHz
Data rate:	3, 4.5, 6, 9, 12, 18, 24, and 27 Mb/s
Subcarrier modulation:	BPSK, QPSK, and 16QAM
Coded rate:	1/2 and 3/4
Number of subcarriers:	52
Symbol interval:	8.0 μ s
Guard interval:	1.6 μ s
PSDU length:	1000 octets
Data:	511-bit pseudo-random test sequence (refer to ITU-T Recommendation O.150)

(3) Conditions for unit under test (UUT)

The UUT shall not transmit.

5.2.3 Maximum input power for reception

The method of measurement conforms to the method specified in 5.2.2.1.

5.2.4 Blocking characteristics

The method of measurement conforms to the method shown below. Other conditions are the same as those specified in 5.2.2.1.

(1) Measuring system diagram

Figure 5-3 shows a system diagram for blocking characteristics measurement.

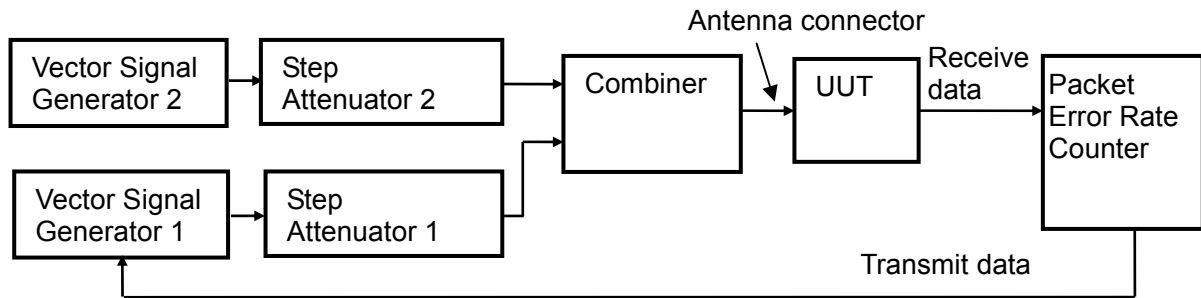

Figure 5-3 Blocking characteristics measurement system diagram

(2) Conditions for measuring instruments

The signal conforming to this standard is generated by vector signal analyzer 1, and the interference signal is generated by vector signal analyzer 2. The condition of the interference signal is one of the following waves so that interference is strongest:

- LTE 5 MHz modulation wave (Refer to ARIB STD-T104)

The test frequency is from 743 MHz to 748 MHz or from 773 MHz to 778 MHz. The average power in the frequency band is defined in Table 3-5 and Table 3-6.

- Continuous wave

The test frequency is 748 MHz or 773 MHz.

(3) Conditions for unit under test (UUT)

The UUT shall not transmit.

5.3 Controller

5.3.1 Interference prevention Function (mobile station)

The measurement method of the Interference prevention function (mobile station) is described in the section, "Interference prevention function" of "TELEC-T257 Characteristic Test Methods on 700 MHz band Intelligent Transport Systems".

5.3.2 Carrier Sense Function (mobile station)

The measurement method of the Carrier sense (mobile station) is described in the section, "Carrier Sense Function" of "TELEC-T257 Characteristic Test Methods on 700 MHz band Intelligent Transport Systems".

5.3.3 Transmission time control function

The measurement method of the Transmit time control function is described in the section, "Transmit time control function" of "TELEC-T257 Characteristic Test Methods on 700 MHz band Intelligent Transport Systems".

Empty page

Chapter 6 Definitions and Abbreviations

6.1 Glossary

The following definitions are used in the glossary of this standard:

[Carrier Sense Multiple Access / Collision Avoidance: CSMA/CA]

In this communication method, transmit data by inspecting the status of the channel before the communication begins, transmitting to the case where the channel is unused at once, and using a random waiting period for the case where the channel is busy after the channel unused changes while warding off a collision.

[IVC-RVC Service Data Unit: ISDU]

Data units exchanged between Layer 7 and Inter-Vehicle and Roadside-to-Vehicle Communication information Layer

[IVC-RVC Protocol Data Unit: IPDU]

Data units exchanged for Inter-Vehicle and Roadside-to-Vehicle Communication information Layer (IVC-RV C Layer)

[LLC Service Data Unit: LSDU]

Data unit exchanged for the Inter-Vehicle and Roadside-to-Vehicle Communication information Layer between the LLC sublayer of Layer 2

[LLC Sublayer]

To conduct the packet transmission between entities in a high-ranking layer, the confirmation conducting connectionless type service is provided.

[LLC Protocol Data Unit: LPDU]

Data units exchanged in the LLC sub-interlayer of Layer 2

[MAC Service Data Unit: MSDU]

Data unit exchanged for the LLC sublayer of Layer 2 between the MAC sublayer

[MAC Control field]

Frame part where the control information field to perform control to which the MAC sublayer of Layer 2 is appropriate is maintained

[MAC Sublayer]

Part where telecommunications management of the transmission channel of Layer 1 is conducted

[MAC Protocol Data Unit: MPDU]

Data units exchanged in the MAC sub-interlayer of Layer 2

[TELECOM]

Abbreviation of the Telecom Engineering Center

[Application Service Data Unit: ASDU]

Data unit exchanged for application between Layer 7

[Application Protocol Data Unit: APDU]

Data units exchanged between Layer 7

[Mobile Station]

The radio station that installed it in the vehicle is shown. "Land mobile station" means it is the same.

[Octet, oct]

Element composed of a binary array of 8 bits

[Base Station]

Radio station set up on road side

[Service]

Function offered to adjacent high-layer

[Service Primitive: SP]

It is a summary of the communication between the service user and the service provider actually embodied as one-independent processing.

[Service User]

Application service element or user element that uses the services of a service provider

[Inter-Vehicle and Roadside-to-Vehicle Communication information Layer: IVC-RVC Layer]

Hierarchy by which the necessary parameter for generation, management, and transmission control of the necessary information for Inter-Vehicle and Roadside-to-Vehicle Communication is received in the MAC sublayer and the function to pass offers it

[Inter-Vehicle Communication]

Mobile communication method to perform radio communication between mobile stations installed in two or more vehicles

[Data Link]

It is the interconnection communication between terminal units of two or more operation channels for information interchange.

[Media Access Control (MAC)]

The data processing activity part where the Media Access Control function provided in the LLC sublayer subordinate position in part of Layer 2 is supported (The control protocol of this communication entity controls a physical transmission channel of Layer 1 of the frame control and the lower-layer of the data format.)

[Protocol Data Unit]

Data units exchanged between isotropy protocols

[Physical Protocol Data Unit: PPDU]

Data units exchanged in the PMD sub-interlayer of Layer 1

[Land mobile station]

“Mobile Station” synonym

[Link Address]

Initial service access point address of LPDU that identifies SAP set to receive PDU or SAP that transmits PDU (same as Media Access Control address system provided at IEEE 802 Commission)

[Physical Layer: L1]

A conceptual hierarchy by which the signal transmission in a physical medium is performed is indicated. (The interface is offered to a physical layer and good Layer 2)

[Data Link Layer: L2]

A conceptual hierarchy by which the data link is controlled is indicated. (The interface is offered to a data link layer and a good Inter-Vehicle and Roadside-to-Vehicle Communication information Layer)

[Application Layer: L7]

The hierarchy of the function for general processing to various applications is indicated. (The interface is offered to the application)

[Roadside-to-Vehicle communications]

Mobile communication method to perform radio communication to the base station of a road side installation and a vehicle equipped with a mobile station

6.2 Abbreviations

This standard uses the following abbreviations:

[A]

ADU	: Application Data Unit
ALME	: Application Layer Management Entity
AP	: Application
APDU	: Application Protocol Data Unit
ARIB	: Association of Radio Industries and Businesses
ASDU	: Application Service Data Unit

[B]

BPSK : Binary Phase Shift Keying

[C]

CCA : Clear Channel Assessment

CRC : Cyclic Redundancy Check

CSMA : Carrier Sense Multiple Access

CSMA/CA : Carrier Sense Multiple Access/Collision Avoidance

[D]

DSAP : Destination Service Access Point

[E]

ELT : Elapsed Time

ENT : Entry

[F]

FCS : Frame Check Sequence

FEC : Forward Error Correction

[G]

GPS : Global Positioning System

[I]

IEEE : Institute of Electrical and Electronics Engineers

IP : Internet Protocol

IPDU : IVC-RVC Protocol Data Unit

IRLME : IVC-RVC Layer Management Entity

ISDU : IVC-RVC Service Data Unit

ITU : International Telecommunication Union

IVC-RVC : Inter-Vehicle Communication and Roadside-to-Vehicle Communication

[L]

L1 : Physical Layer

L2 : Data Link Layer

L7 : Application Layer
LLC : Logical Link Control
LME : Layer Management Entity
LPDU : LLC Protocol Data Unit
LSDU : LLC Service Data Unit
LSB : Least Significant Bit

[M]

MAC : Medium Access Control
MIB : Management Information Base
MLME : MAC Sublayer Management Entity
MPDU : MAC Protocol Data Unit
MSB : Most Significant Bit
MSDU : MAC Service Data Unit

[N]

NST : NAV, Start Timing
NVP : NAV, Valid Period

[O]

OFDM : Orthogonal Frequency Division Multiplexing
OGT : OBE Guard Time
ONC : OBE, NAV Control
OPC : OBE Packet Counter
ORT : OBE, RVC Information Table
ORV : OBE, RVC Valid Period
OTI : OBE, Transmission Information
OSI : Open System Interconnection

[P]

PDU : Protocol Data Unit
PHY : Physical Layer
PHY-SAP : Physical Layer Service Access Point
PLCP : Physical Layer Convergence Protocol
PLME : Physical Layer Management Entity

ARIB STD-T109

PMD : Physical Medium Dependent
PN : Pseudo Noise (PN code sequence)
PPDU : Physical Layer Protocol Data Unit
PSDU : PLCP SDU

[Q]

QAM : Quadrature Amplitude Modulation
QPSK : Quadrature Phase Shift Keying

[R]

RCN : RVC Communication Number
RCP : RVC Communication Period
RPC : RSU Packet Counter
RRC : RSU, RVC Control
RTC : RSU, Transmission Control

[S]

SAP : Service Access Point
SDU : Service Data Unit
SNAP : Subnetwork Access Protocol
SME : System Management Entity
SP : Service Primitive
SSAP : Source Service Access Point
STA : Status
SYN : Synchronization

[T]

TC : Time Counter
TRC : Transmission Count
TRP : Transmission Period
TST : Transmission Start Timing

Annex

Annex 1 Protocol parameters

1 Layer 1

1.1 Management information base (MIB)

Table S1-1 Layer 1 management information base

Parameter	Meaning	Type	Length	Value	NOTE
PHY type	Modulation method	INTEGER	8 bit	04	Fixed value
Current reg domain	Regulation identification	Integer32	8 bit	40	Fixed value
Number supported power levels	Antenna power number	INTEGER	4 bit	1	Fixed value
Tx power level 1	Antenna power level 1	INTEGER	2 oct	0..10000	Power value [mW] (natural number)

2 Layer 2

2.1 Management information base (MIB)

Table S1-2 Layer 2 management information base

Parameter	Meaning	Type	Length	Value	NOTE
MACAddress	MAC Address	OCTET STRING	6 oct		
TC	Corrected value of Timer	INTEGER	4 oct	-999999 ..999999	
RPC	Transmission packetcounter for base station	INTEGER	1 oct	0..255	
OPC	Transmission packetcounter for mobile station	INTEGER	1 oct	0..255	

3 Inter-vehicle Communication and Roadside-to-vehicle Communication Control Layer (IVC-RVC Layer)

3.1 Management Information Base (MIB)

Table S1-3 Base station variables

Parameter	Meaning	Type	Length	Value	NOTE
RRC(n)					n=1..16
TRC	Transmission Count	INTEGER	1 oct	0..3	
RCP	RVC Period Duration	INTEGER	1 oct	0..63	
RTC(m)					The size m is implementation-dependent
TST	Transmission Timing	INTEGER	2 oct	0..6249	
TRP	Transmission Period Duration	INTEGER	2 oct	0..6250	

Table S1-4 Mobile station variables

Parameter	Meaning	Type	Length	Value	NOTE	
ORV	RVC Period Information Valid Time	INTEGER	2 oct	300..65536		
OGT	Guard Time	INTEGER	1 oct	4..63		
ORT	RVC Period Information Table					
	SYN	Synchronization Information				
	STA	Status	BIT STRING	3 bit	0..7	0 : Unsynchronized 1..3 : Not in use 4 : Synchronized directly with a base station 5 : Synchronized by using the information transferred once 6 : Synchronized by using the information transferred twice 7 : Synchronized by using the information transferred three times
	ELT	Elapsed Time	INTEGER	—	—	The length and the value are implementation-dependent.
	ENT(r)	RVC Period Information Entry				The size r is implementation-dependent.
RCN	RVC Period Number	INTEGER	1 oct	1..16		

	TRC	Transmission Count	INTEGER	1 oct	0..3	
	RCP	RVC Period Duration	INTEGER	1 oct	0..63	
	ELT	Elapsed Time	INTEGER	—	—	The length and the value are implementation-dependent.
OTI(n)		RVC Period Transmission Information				n=1..16
	TRC	Transmission Count	INTEGER	1 oct	0..2	
	RCP	RVC Period Duration	INTEGER	1 oct	0..63	
ONC(n)		Transmission Inhibition Period Control				n=1..16
	NST	Transmission Inhibition Period Start Timing	INTEGER	2 oct	0..6249	
	NVP	Transmission Inhibition Period Duration	INTEGER	2 oct	0..6250	

Annex 2 Application data structure definitions

1 Application Data of a Mobile Station

```
MobileStationBroadcastData DEFINITIONS ::=
BEGIN
```

```
ControlInformation ::= SEQUENCE{
    DataRate      DataRateParameter
    reserve      INTEGER(0..15)      -- Reserved for future use
}
```

```
-- The control parameter (modulation method/data rate) of radio communication
```

```
DataRateParameter ::= INTEGER {
    BPSK1/2      (1)
    BPSK3/4      (2)
    QPSK1/2      (0),
    QPSK3/4      (3),
    16QAM1/2     (4),
    16QAM3/4     (5),
```

```
-- The values from 6 to 15 are reserved for DataRateParameter.
}(0..15)
```

```
SecurityClassification ::= BOOLEAN
```

```
-- If it is true, goes through the security procedure.
```

```
-- If it is false, does not go through the security procedure.
```

```
SecurityInformation ::= OCTET STRING(SIZE(20))
```

```
-- Security information
```

```
ApplicationAssociatedInformation ::= BIT STRING(SIZE(8))
```

```
-- Application associated information
```

```
ApplicationDataLength ::= INTEGER(0..1500)
```

```
-- Application data length

ApplicationData ::= OCTET STRING(SIZE(0..1500))
-- Application data

LinkAddress ::= OCTET STRING(SIZE(6))
-- Destination link address

END
```

2 Application Data of a Base Station

```
BaseStationBroadcastData DEFINITIONS ::=
BEGIN

SequenceNumber ::= SEQUENCE{
    Sequence      INTEGER(1..255)      -- Sequence information
    TotalNumber   INTEGER(1..255)      -- Total number
}

ControlInformation ::= SEQUENCE{
    DataRate      DataRateParameter
    reserve       INTEGER(0..15)      -- Reserved for future use
}
-- The control parameter (modulation method/data rate) of radio communication

DataRateParameter ::= INTEGER {
    BPSK1/2      (1)
    BPSK3/4      (2)
    QPSK1/2      (0),
    QPSK3/4      (3),
    16QAM1/2     (4),
    16QAM3/4     (5),
```

-- The values from 6 to 15 are reserved for DataRateParameter.
}(0..15)

SecurityClassification ::=BOOLEAN

-- If it is true, goes through the security procedure.

-- If it is false, does not go through the security procedure.

SecurityInformation ::= OCTET STRING(SIZE(20))

-- Security information

ApplicationAssociatedInformation ::= BIT STRING(SIZE(8))

-- Application associated information

ApplicationDataLength ::= INTEGER(0..1500)

-- Application data length

ApplicationData ::= OCTET STRING(SIZE(0..1500))

-- Application data

LinkAddress ::= OCTET STRING(SIZE(6))

-- Destination link address

END

Empty page

Description

Description 1 Estimation of transmittable packets in a roadside-to-vehicle transmission period

This Description indicates how a base station estimates whether it can transmit the packets in a Roadside-to-Vehicle transmission period. Refer to [1] “17.4.3 OFDM TXTIME calculation” for the calculation method of the transmission time.

1 Overview

The MAC sublayer of a base station estimates whether one or more packets received from the LLC sublayer can be transmitted in Roadside-to-Vehicle transmission periods. Only those packets that can be transmitted in Roadside-to-Vehicle transmission periods are to be sent to Layer 1. For this purpose, the MAC sublayer issues PLME-TXTIME.request primitive to obtain the time required to transmit each packet. The following sections illustrate the calculation procedure and an example according to [1], and also describe the calculation method of the transmission time when plural packets are transmitted consecutively.

2 Calculation of time for transmitting one packet

The time required for transmitting one packet depends on the length and data rate of the packet. The following example shows the calculation in the case where the length of MSDU is 400 octets and the data rate is 12 Mb/s in the frame format shown in Figure C1-1.

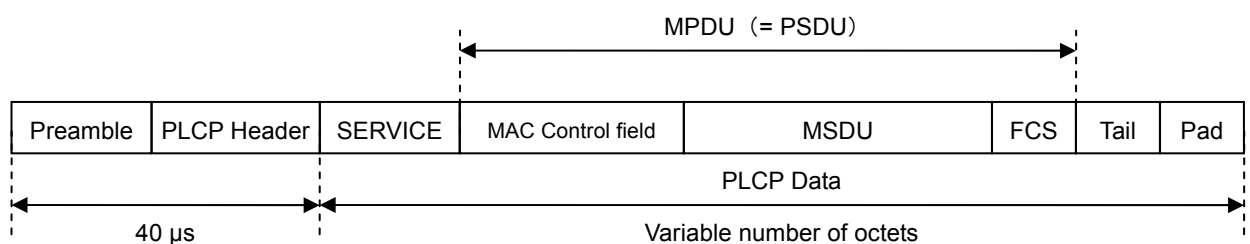

Figure C1-1 Frame format

(1) Calculation of the length of MPDU

In this example, the length of MPDU is 428 octets with MSDU (400 octets), MAC Control field (24 octets) and FCS (4 octets).

(2) Calculation of the length of PLCP Data

The PLCP Data consists of MPDU (428 octets), SERVICE (16 bits), Tail (6 bits) and Pad. Pad is set up so that the size of PLCP Data may become the length of the integral multiple of the number of data bits (96) contained in one OFDM symbol. In this example, the total size of MPDU, SERVICE and Tail is 3446 bits (= 428 * 8 + 16 + 6). An OFDM symbol contains 96 data bits, so 10 bits of Pad are added to 3446 bits so that the length of PLCP Data becomes 3456 bits (36 OFDM symbols).

(3) Calculation of total time of transmitting a packet

In this example, the total time of transmitting a packet is 328 μs which consists of the transmission time of Preamble and PLCP Header (40 μs) and that of PLCP Data (288 μs = 36 OFDM symbols * 8 μs/symbol). Taking the standby time of the short interframe space (32 μs) into consideration, the total time will be 360 μs.

3 Calculation of time for transmitting plural packets consecutively

When a base station transmits plural packets in a Roadside-to-Vehicle transmission period, the total time should be calculated taking into consideration the short interframe space between packets. For example, the necessary transmission time of three packets is shown in Figure C1-2. When each necessary transmission time of three packets is 300 μs, 400 μs and 200 μs, the total necessary transmission time will be 996 μs (= 32 + 300 + 32 + 400 + 32 + 200), which includes short interframe spaces.

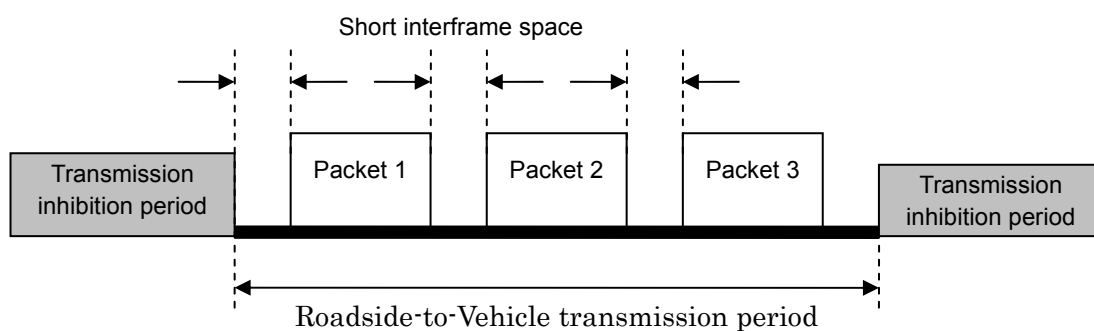

Figure C1-2 Transmission of plural packets in a Roadside-to-Vehicle transmission period

<In case plural Roadside-to-Vehicle transmission periods are set>

The following example illustrates how a base station transmits five packets in two Roadside-to-Vehicle transmission periods. In the two examples, each Roadside-to-Vehicle

transmission period is set to 1600 μs and 1200 μs .

[Example 1]

In the first example, the transmission time of each of these five packets is shown below.

Packet 1: 600 μs Packet 2: 600 μs Packet 3: 200 μs

Packet 4: 700 μs Packet 5: 400 μs

(MAC sublayer receives in order of Packet 1 to Packet 5 from the LLC sublayer.)

In this case, the necessary transmission time of Packet 1 to Packet 3 is 1496 μs ($= 32 + 600 + 32 + 600 + 32 + 200$). The value is less than the first Roadside-to-Vehicle transmission period (1600 μs), so the base station can transmit these three packets in the first Roadside-to-Vehicle transmission period. However, the base station cannot transmit four packets from Packet 1 to Packet 4 in the first Roadside-to-Vehicle transmission period because the total transmission time of these four packets is 2228 μs ($= 1496 + 32 + 700$) and the value is more than 1600 μs . Next, the base station can transmit the other two packets Packet 4 and Packet 5 in the second Roadside-to-Vehicle transmission period, because the necessary transmission time of these packets is 1164 μs ($= 32 + 700 + 32 + 400$) and the value is less than the second Roadside-to-Vehicle transmission period (1200 μs).

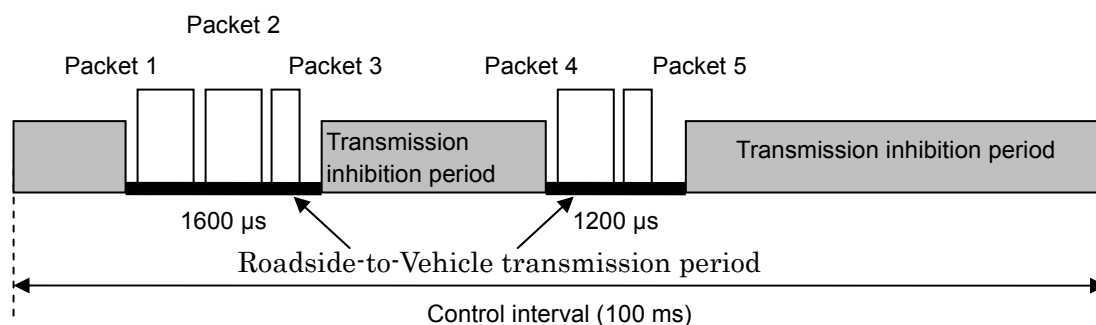

Figure C1-3 Transmission of plural packets in plural Roadside-to-Vehicle transmission periods

[Example 1]

[Example 2]

In the second example, the transmission time of each of the five packets is shown below.

Packet 1: 600 μs Packet 2: 600 μs Packet 3: 700 μs

Packet 4: 200 μs Packet 5: 400 μs

(MAC layer receives in order of Packet 1 to Packet 5 from the LLC sublayer.)

In this case, the necessary transmission time of Packet 1 and Packet 2 is $1264 \mu\text{s}$ ($= 32 + 600 + 32 + 600$). The value is less than the first Roadside-to-Vehicle transmission period ($1600 \mu\text{s}$), so the base station can transmit these two packets in the first Roadside-to-Vehicle transmission period. However, the base station cannot transmit three packets from Packet 1 to Packet 3 because the total transmission time of these three packets is $1996 \mu\text{s}$ ($= 1264 + 32 + 700$), which is more than $1600 \mu\text{s}$. Next, the necessary transmission time of the other three packets, Packet 3 to Packet 5 is $1396 \mu\text{s}$ ($= 32 + 700 + 32 + 200 + 32 + 400$), so the base station cannot transmit these packets. In this case, the base station is to transmit only two packets, Packet 3 and Packet 4 of which the necessary transmission time is $964 \mu\text{s}$ ($= 32 + 700 + 32 + 200$) in the second Roadside-to-Vehicle transmission period ($1200 \mu\text{s}$) and discard Packet 5 because there is not enough time to transmit it in the second Roadside-to-Vehicle transmission period.

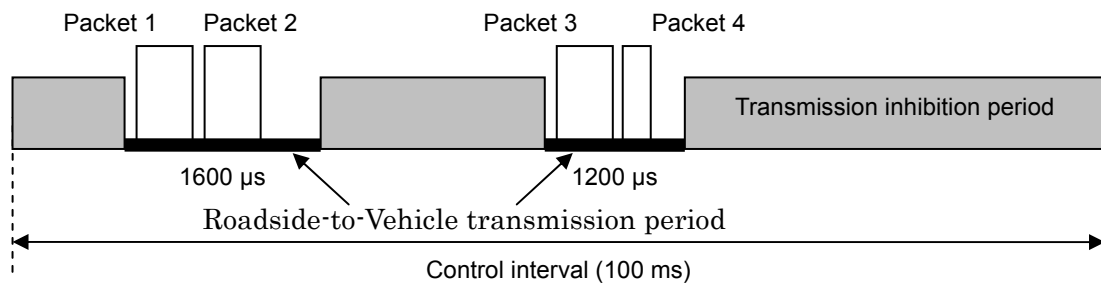

Figure C1-4 Transmission of plural packets in plural Roadside-to-Vehicle transmission periods
[Example 2]

Description 2 An example of the method for synchronizing plural base stations

This Description describes an example of synchronization of plural base stations.

1 Overview

In the time division multiple access system for Inter-Vehicle communication (IVC) and Roadside-to-Vehicle communication (RVC), base stations shall be synchronized accurately so as to avoid collisions among packets transmitted from base stations and mobile stations. The following example shows the concrete method of synchronizing plural base stations.

2 Synchronization of plural base stations

In order to prevent mobile stations from suffering or giving interference even where base stations are located separately from each other and cannot communicate with each other, it is desirable that all base stations operate with the same clock time. For this purpose, all base stations synchronize their one second cycle timer with the 1PPS signal from GPS receivers. As a result, the one second cycle timer can be synchronized with the value for less than 1 second of Universal Time Coordinated (UTC).

As shown below, there are two methods of synchronizing plural base stations. One is the method of synchronizing with 1PPS signal output from a GPS receiver and the other is with the time information in the received packet from other base stations.

2.1 Synchronization with 1PPS signals from GPS receivers (GPS synchronization)

As shown in Figure C2-1, when base stations can receive 1PPS signal from a GPS receiver, each of these base stations synchronizes one second cycle time to 1PPS, and synchronizes with UTC. (GPS synchronization)

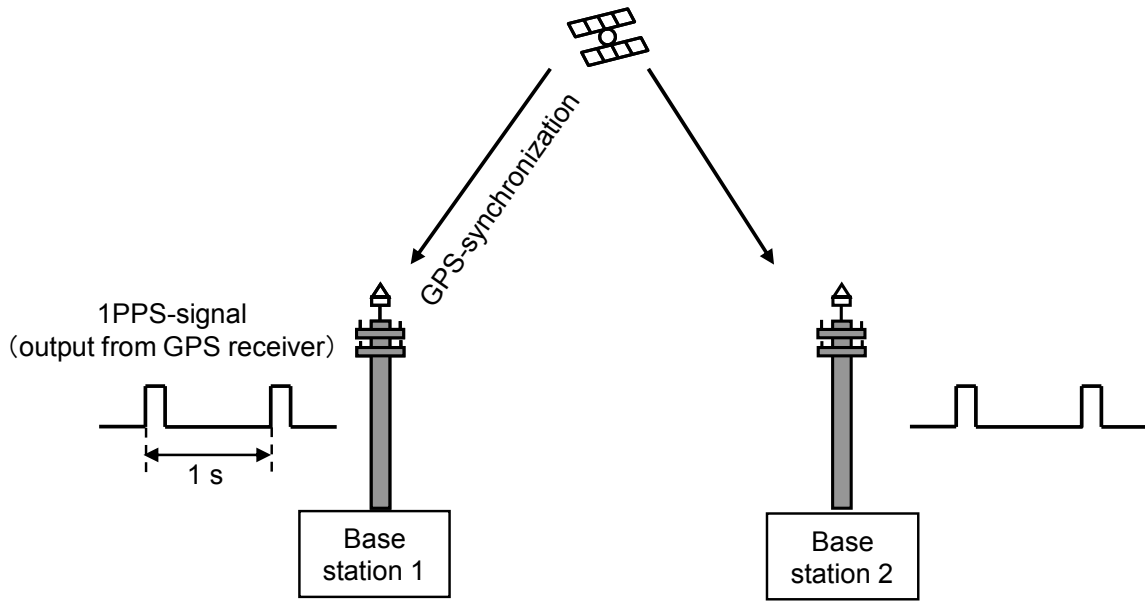

Figure C2-1 Synchronization with 1PPS signal

Actually, the one second cycle timer is reset to 0 in synchronization with the positive edge of the 1PPS signal as shown in Figure C2-2.

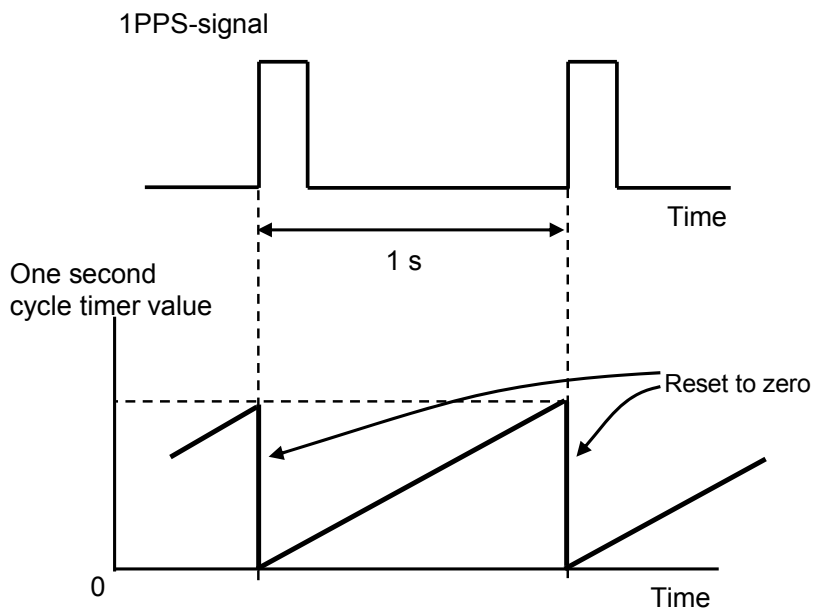

Figure C2-2 Resetting one second cycle timer with 1PPS signal

2.2 Synchronization by receiving packets from other base stations (Over-the-air synchronization)

When a base station cannot receive a 1PPS signal from GPS receivers, the base station synchronizes its one second cycle timer with the transmission time information included in the received packet from other base stations (Over-the-air synchronization). This concrete synchronization procedure is described below and shown in Figure C2-3.

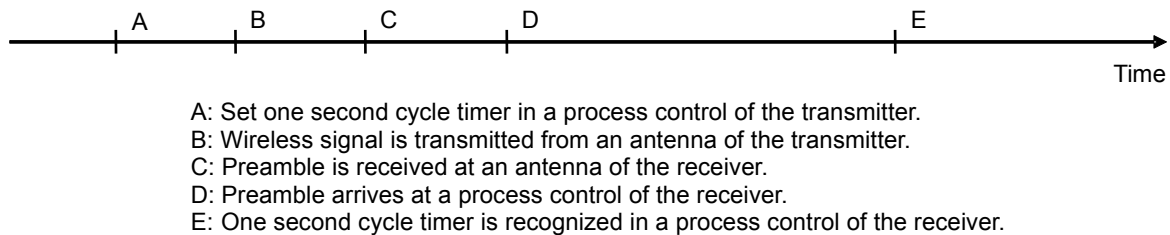

Figure C2-3 Procedure of Over-the-air synchronization

(1) Preparation

- Before transmitting a packet, a base station measures the delay time between the time which the timer value is set to the packet (at the timing of A) and the time which the packet arrives at the antenna (at the timing of B).
- Before receiving a packet, a base station measures the delay time between the time which the preamble of the packet arrives at the antenna (at the timing of C) and the time which the preamble arrives in the control unit (at the timing of D).

(2) Operation

- In the case of transmitting a packet, a base station sets the timestamp to the transmission packet. The value of the timestamp is calculated by adding the previously-measured time between A and B to the timer value at the timing of A.
- In the case of receiving a packet, the base station firstly reads the timestamp value from the received packet. Next, the base station adds two interval time values, which are the previously measured time between C and D, and the time between D and E. The base station recognizes the calculated timer value as the present timer value of the transmitter. Another way is that the base station firstly memorizes its own one second cycle timer value at the timing of C and corrects the difference between the memorized timer value and the timer value from the received packet at

the timing of E.

3 Monitoring the synchronization status of other base stations and choosing the method of synchronization

Base stations that can communicate with each other monitor the accuracy of synchronization of other base stations. In the case where one base station finds that the accuracy of other base stations becomes worse, the failure information should be recorded.

3.1 Monitoring target and synchronization target

The monitoring target and synchronization target are determined as follows: (Figure C2-4).

- Base stations that use GPS synchronization monitor all the base stations that can communicate with them. They do not use over-the-air synchronization because they are synchronized with the 1PPS signal.
- Base stations that use over-the-air synchronization monitor other base stations that similarly use over-the-air synchronization. Their synchronization target should be base stations that use GPS synchronization, and the signal intensity of the reception packet should be stronger. If they cannot synchronize with desired base stations, the synchronization target can be base stations that use over-the-air synchronization.

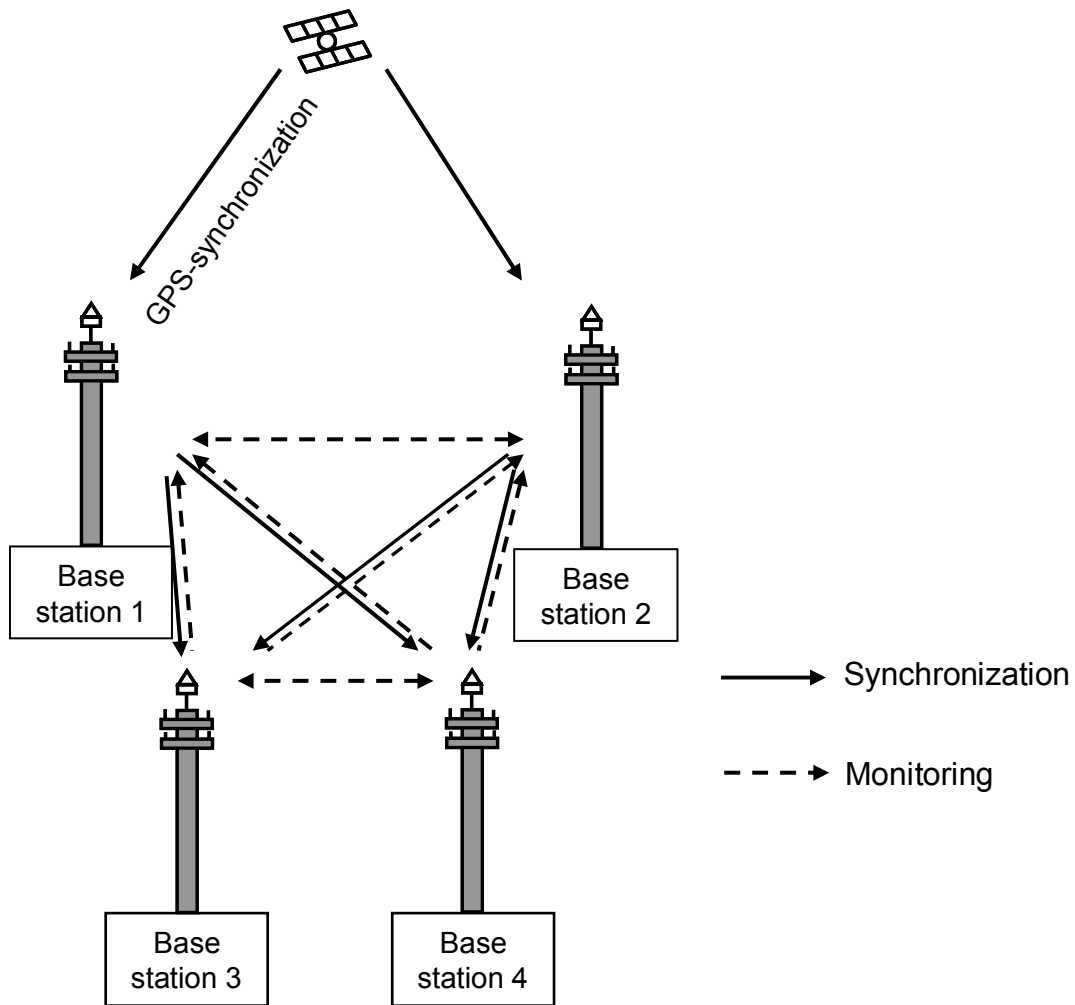

Figure C2-4 Monitoring target and synchronization target

3.2 Procedure of monitoring and synchronizing

(1) Case of GPS synchronization

With the same procedure described in 2.2, the base stations obtain timestamps of all the receivable packets from other base stations. Then the base station calculates the difference between its own timer value and other obtained timer values. As a result of comparing two or more timer values, if the difference exceeds a threshold, failure information should be recorded.

As a result of the above comparison, when its own timer value is considered to be correct, the base station continues GPS synchronization.

(2) Case of Over-the-air synchronization

With the same procedure described in 2.2, the base station obtains the timer value of

all the receivable packets from other base stations that use Over-the-air synchronization. If the difference of the timer values exceeds a threshold, failure information should be recorded.

If no failure is found, the base station continues Over-the-air synchronization and the synchronization target shall be selected according to the status of the target basic station (whether the target uses GPS synchronization or Over-the-air synchronization) and the signal intensity.

Amendment History

700 MHz BAND INTELLIGENT TRANSPORT SYSTEMS
(ARIB STD-T109)

The 1.1th edition amendment history

Page	Para. no	Content of Amendment	Present	Reason												
14	3.2.2.4	<p>3.2.2.4 Blocking characteristics</p> <p>Table 3-5 Interference signal (base station)</p> <table border="1"> <tr><td>Frequency band</td></tr> <tr><td>More than 710 MHz and <u>748</u> MHz or less</td></tr> <tr><td>More than <u>773</u> MHz and 810 MHz or less</td></tr> </table> <p>Table 3-6 Interference signal (mobile station)</p> <table border="1"> <tr><td>Frequency band</td></tr> <tr><td>More than 710 MHz and <u>748</u> MHz or less</td></tr> <tr><td>More than <u>773</u> MHz and 810 MHz or less</td></tr> </table>	Frequency band	More than 710 MHz and <u>748</u> MHz or less	More than <u>773</u> MHz and 810 MHz or less	Frequency band	More than 710 MHz and <u>748</u> MHz or less	More than <u>773</u> MHz and 810 MHz or less	<p>3.2.2.4 Blocking characteristics</p> <p>Table 3-5 Interference signal (base station)</p> <table border="1"> <tr><td>Frequency band</td></tr> <tr><td>More than 710 MHz and <u>750</u> MHz or less</td></tr> <tr><td>More than <u>770</u> MHz and 810 MHz or less</td></tr> </table> <p>Table 3-6 Interference signal (mobile station)</p> <table border="1"> <tr><td>Frequency band</td></tr> <tr><td>More than 710 MHz and <u>750</u> MHz or less</td></tr> <tr><td>More than <u>770</u> MHz and 810 MHz or less</td></tr> </table>	Frequency band	More than 710 MHz and <u>750</u> MHz or less	More than <u>770</u> MHz and 810 MHz or less	Frequency band	More than 710 MHz and <u>750</u> MHz or less	More than <u>770</u> MHz and 810 MHz or less	Change related to law revision
Frequency band																
More than 710 MHz and <u>748</u> MHz or less																
More than <u>773</u> MHz and 810 MHz or less																
Frequency band																
More than 710 MHz and <u>748</u> MHz or less																
More than <u>773</u> MHz and 810 MHz or less																
Frequency band																
More than 710 MHz and <u>750</u> MHz or less																
More than <u>770</u> MHz and 810 MHz or less																
Frequency band																
More than 710 MHz and <u>750</u> MHz or less																
More than <u>770</u> MHz and 810 MHz or less																
14	3.2.3.1	<p>3.2.3.1 Interference prevention function (RERL: Article 6-2, ORE: Article 9-4, <u>NT: No.446, 2012</u>)</p> <p>The radio equipment of each mobile station shall automatically transmit/receive an identification code that is managed by an organization approved by the Minister <u>for Internal Affairs and Communications.</u></p>	<p>3.2.3.1 Interference prevention function (RERL: Article 6-2, ORE: Article 9-4)</p> <p>The radio equipment of each mobile station shall automatically transmit/receive an identification code that is managed by an organization approved by the Minister <u>of Public Management, Home Affairs, Posts and Telecommunications.</u></p>	Change related to law revision and correction												

15	3.2.3.2	3.2.3.2 Carrier sense function (ORE: Article 49-22-2, NT: No.444, 2012)	3.2.3.2 Carrier sense function (ORE: Article 49-22-2, NT: No.528, 2011)	Change related to law revision
15	3.2.3.3	3.2.3.3 Transmission time control function (ORE: Article 49-22-2, NT: No.444, 2012)	3.2.3.3 Transmission time control function (ORE: Article 49-22-2, NT: No.528, 2011)	Change related to law revision
16	3.2.5.1	<p>3.2.5.1 Cabinet (ORE: Article 49-22-2, OTF: Article 9, NT: No.444, 2012)</p> <p>The cabinet shall be of tamper-proof construction. However, this provision does not apply to the power supply equipment, antenna and <u>the following equipment specified in the Notification of the Ministry of Internal Affairs and Communications.</u></p> <p><u>The following radio equipment does not need to be contained within the same cabinet.</u></p> <p>(1) <u>Displays indicating the operation status of transmitter equipment and receiver equipment</u></p> <p>(2) <u>Accessory equipment for data processing and other parts subjected to the same category.</u></p> <p>(3) <u>Signal processing equipment</u></p>	<p>3.2.5.1 Cabinet (ORE: Article 49-22-2, OTF: Article 9)</p> <p>The cabinet shall be of tamper-proof construction. However, this provision does not apply to the power supply equipment, antenna and <u>related parts.</u></p>	Change related to law revision
68	4.4.3.3.2	<p>4.4.3.3.2 Mobile station</p> <p>(7) Procedure of updating the Transmission Inhibition Period Control variable (ONC)</p> <p>The ONC[n].NVP shall be set to</p>	<p>4.4.3.3.2 Mobile station</p> <p>(7) Procedure of updating the Transmission Inhibition Period Control variable (ONC)</p> <p>The ONC.NVP shall be set to the</p>	Correction

		the value that is a unit number corresponding to the entry plus three times the ORT.ENT.RCP and twice the OGT. If the derived value is larger than 6250, the ONC.NVP shall be set to 6250.	value that is a unit number corresponding to the entry plus three times the ORT.ENT.RCP and twice the OGT. If the derived value is larger than 6250, the ONC.NVP shall be set to 6250.	
83	4.5.3.1.1	<u>4.5.3.1.1</u> The format of Layer 7 protocol data unit	<u>4.5.3.1.2</u> The format of Layer 7 protocol data unit	Correction
83	4.5.3.1.2	<u>4.5.3.1.2</u> PDU elements of Layer 7	<u>4.5.3.1.3</u> PDU elements of Layer 7	Correction
94	5.2.4	<p>5.2.4 Blocking characteristics</p> <p>(2) Conditions for measuring instruments</p> <ul style="list-style-type: none"> - LTE 5 MHz modulation wave (Refer to ARIB STD-T104) <p>The test frequency is from <u>743 MHz to 748 MHz or from 773 MHz to 778 MHz</u>. The average power in the frequency band is defined in Table 3-5 and Table 3-6.</p> <ul style="list-style-type: none"> - Continuous wave <p>The test frequency is <u>748 MHz or 773 MHz</u>.</p>	<p>5.2.4 Blocking characteristics</p> <p>(2) Conditions for measuring instruments</p> <ul style="list-style-type: none"> - LTE 5 MHz modulation wave (Refer to ARIB STD-T104) <p>The test frequency is from <u>745 MHz to 750 MHz or from 770 MHz to 775 MHz</u>. The average power in the frequency band is defined in Table 3-5 and Table 3-6.</p> <ul style="list-style-type: none"> - Continuous wave <p>The test frequency is <u>747.5 MHz or 772.5 MHz</u>.</p>	Change related to law revision

To: Secretariat of Standard Assembly Meeting of the Association of Radio Industries and Businesses
 FAX: +81-3-3592-1103 E-mail:std@arib.or.jp
 Nittochi Bldg. 11th Floor, 1-4-1 Kasumigaseki, Chiyoda-ku, Tokyo 100-0013, Japan

Communication Note of ARIB Standard-related Proposals, etc.

ARIB Standard Name (No.)	700 MHz BAND INTELLIGENT TRANSPORT SYSTEMS (ARIB STD-T109)		
Sections to be completed by sender			
Name:	Date	/	/
TEL:	FAX:	E-mail:	
Company name Department name			
Page / Section	(Please describe your proposal or present your questions or comments in concrete terms.)		
(Response)	Sections to be completed by secretariat		
	Date of receipt	/	/
Classification:	Ref. No.	—	
	Remarks		

Please send your ARIB Standard-related question in this format.

If you complete this form in English, please provide Japanese translation alongside the English.

700 MHz BAND
INTELLIGENT TRANSPORT SYSTEMS

ARIB STANDARD

ARIB STD-T109 VERSION 1.1

Version 1.0 February 14th 2012
Version 1.1 December 18th 2012

Published by
Association of Radio Industries and Businesses

11F, Nittochi Building,
1-4-1 Kasumigaseki, Chiyoda-ku, Tokyo 100-0013, Japan
TEL 81-3-5510-8590
FAX 81-3-3592-1103

Printed in Japan
All rights reserved
