



**ARIB STD-T64-C.S0065-C v1.0**

**cdma2000 Application on UICC  
for Spread Spectrum Systems**

---

Refer to "Industrial Property Rights (IPR)" in the preface of ARIB STD-T64 for Related Industrial Property Rights. Refer to "Notice" in the preface of ARIB STD-T64 for Copyrights

# 1 **Original Specification**

---

2 This standard, ARIB STD-T64-C.S0065-C v1.0, was prepared by 3GPP2-WG of Association of  
3 Radio Industries and Businesses (ARIB) based upon the 3GPP2 specification, C.S0065-C v1.0.

4

# 5 **Modification to the original specification**

---

6 None.

7

# 8 **Notes**

---

9 None.

10

**3GPP2 C.S0065-C v1.0**

*March 2014*



**3RD GENERATION  
PARTNERSHIP  
PROJECT 2  
"3GPP2"**

---

## ***cdma2000 Application on UICC for Spread Spectrum Systems***

© 2014 3GPP2

3GPP2 and its Organizational Partners claim copyright in this document and individual Organizational Partners may copyright and issue documents or standards publications in individual Organizational Partner's name based on this document. Requests for reproduction of this document should be directed to the 3GPP2 Secretariat at [secretariat@3gpp2.org](mailto:secretariat@3gpp2.org). Requests to reproduce individual Organizational Partner's documents should be directed to that Organizational Partner. See [www.3gpp2.org](http://www.3gpp2.org) for more information.

**Revision History**

<b><u>Revision</u></b>	<b><u>Description</u></b>	<b><u>Date</u></b>
C.S0065-0 v1.0	Initial Release	June 2006
C.S0065-0 v2.0	Point Release	July 2008
	Corrected Point Release	December 2008
C.S0065-A v1.0	Revision A	August 2009
C.S0065-B v1.0	Revision B	January 2010
C.S0065-B v2.0	Revision B Version 2.0	January 2011
C.S0065-B v3.0	Revision B v3.0	January 2014
C.S0065-C v1.0	Revision C	July 2014

# Contents

1		
2	<b>1. INTRODUCTION.....</b>	<b>1</b>
3	1.1 SCOPE .....	1
4	1.2 REQUIREMENTS LANGUAGE .....	1
5	1.3 REFERENCES .....	1
6	1.3.1 Normative References .....	3
7	1.3.2 Informative References .....	6
8	<b>2. VOID .....</b>	<b>7</b>
9	<b>3. VOID .....</b>	<b>8</b>
10	<b>4. DEFINITIONS, SYMBOLS, ABBREVIATIONS AND CODING CONVENTIONS .....</b>	<b>9</b>
11	4.1 CODING CONVENTIONS.....	10
12	4.1.1 CSIM Status Codes.....	10
13	4.2 PARAMETERS STORED TEMPORARILY IN THE CSIM.....	10
14	<b>5. FILES .....</b>	<b>11</b>
15	5.1 CONTENTS OF FILES AT THE MF LEVEL .....	11
16	5.1.1 <i>EF<sub>ICCID</sub></i> (ICC Identification).....	11
17	5.2 CONTENTS OF FILES AT THE CSIM ADF (APPLICATION DF) LEVEL.....	12
18	5.2.1 <i>EF<sub>COUNT</sub></i> (Call Count).....	12
19	5.2.2 <i>EF<sub>IMSI_M</sub></i> (IMSI_M).....	13
20	5.2.3 <i>EF<sub>IMSI_T</sub></i> (IMSI_T).....	16
21	5.2.4 <i>EF<sub>TMSI</sub></i> (TMSI) .....	17
22	5.2.5 <i>EF<sub>AH</sub></i> (Analog Home SID) .....	19
23	5.2.6 <i>EF<sub>AOP</sub></i> (Analog Operational Parameters) .....	20
24	5.2.7 <i>EF<sub>ALOC</sub></i> (Analog Location and Registration Indicators).....	21
25	5.2.8 <i>EF<sub>CDMAHOME</sub></i> (CDMA Home SID, NID) .....	23
26	5.2.9 <i>EF<sub>ZNREGI</sub></i> (CDMA Zone-Based Registration Indicators) .....	25
27	5.2.10 <i>EF<sub>SNREGI</sub></i> (CDMA System-Network Registration Indicators).....	27
28	5.2.11 <i>EF<sub>DISTREGI</sub></i> (CDMA Distance-Based Registration Indicators).....	29
29	5.2.12 <i>EF<sub>ACCOLC</sub></i> (Access Overload Class ACCOLCp).....	31
30	5.2.13 <i>EF<sub>TERM</sub></i> (Call Termination Mode Preferences) .....	32
31	5.2.14 <i>EF<sub>SSCI</sub></i> (Suggested Slot Cycle Index).....	33
32	5.2.15 <i>EF<sub>ACP</sub></i> (Analog Channel Preferences) .....	34
33	5.2.16 <i>EF<sub>PRL</sub></i> (Preferred Roaming List).....	35
34	5.2.17 <i>EF<sub>RUI MID</sub></i> (Removable UIMID) .....	36
35	5.2.18 <i>EF<sub>CSIM_ST</sub></i> (CSIM Service Table).....	37
36	5.2.19 <i>EF<sub>SPC</sub></i> (Service Programming Code).....	40
37	5.2.20 <i>EF<sub>OTAPASPC</sub></i> (OTAPA/SPC_Enabled) .....	42
38	5.2.21 <i>EF<sub>NAMLOCK</sub></i> (NAM_LOCK).....	43
39	5.2.22 <i>EF<sub>OTA</sub></i> (OTASP/OTAPA Features) .....	45
40	5.2.23 <i>EF<sub>SP</sub></i> (Service Preferences) .....	46
41	5.2.24 <i>EF<sub>ESN_MEID_ME</sub></i> (ESN_ME or MEID_ME) .....	47
42	5.2.25 <i>Reserved</i> .....	48

1	5.2.26	<i>EF<sub>LI</sub></i> (Language Indication) .....	49
2	5.2.27	<i>EF<sub>FDN</sub></i> (Fixed Dialing Numbers) .....	50
3	5.2.28	<i>EF<sub>SMS</sub></i> (Short Messages) .....	51
4	5.2.29	<i>EF<sub>SMSP</sub></i> (Short Message Service Parameters).....	53
5	5.2.30	<i>EF<sub>SMSS</sub></i> (SMS Status) .....	57
6	5.2.31	<i>EF<sub>SSFC</sub></i> (Supplementary Services Feature Code Table).....	59
7	5.2.32	<i>EF<sub>SPN</sub></i> (CDMA Home Service Provider Name) .....	62
8	5.2.33	<i>EF<sub>USGIND</sub></i> (UIMID/SF_EUIMID Usage Indicator) .....	64
9	5.2.34	<i>EF<sub>AD</sub></i> (Administrative Data) .....	65
10	5.2.35	<i>EF<sub>MDN</sub></i> (Mobile Directory Number).....	67
11	5.2.36	<i>EF<sub>MAXPRL</sub></i> (Maximum PRL) .....	69
12	5.2.37	<i>EF<sub>SPCS</sub></i> (SPC Status) .....	70
13	5.2.38	<i>EF<sub>ECC</sub></i> (Emergency Call Codes) .....	71
14	5.2.39	<i>EF<sub>ME3GPDOPC</sub></i> (ME 3GPD Operation Capability) .....	73
15	5.2.40	<i>EF<sub>3GPDOPM</sub></i> (3GPD Operation Mode) .....	74
16	5.2.41	<i>EF<sub>SIPCAP</sub></i> (Simple IP Capability Parameters) .....	75
17	5.2.42	<i>EF<sub>MIPCAP</sub></i> (Mobile IP Capability Parameters).....	76
18	5.2.43	<i>EF<sub>SIPUPP</sub></i> (Simple IP User Profile Parameters) .....	77
19	5.2.44	<i>EF<sub>MIPUPP</sub></i> (Mobile IP User Profile Parameters).....	78
20	5.2.45	<i>EF<sub>SIPSP</sub></i> (Simple IP Status Parameters) .....	79
21	5.2.46	<i>EF<sub>MIPSP</sub></i> (Mobile IP Status Parameters) .....	80
22	5.2.47	<i>EF<sub>SIPPAPSS</sub></i> (Simple IP PAP SS Parameters) .....	81
23	5.2.48	Reserved .....	82
24	5.2.49	Reserved .....	82
25	5.2.50	<i>EF<sub>PUZL</sub></i> (Preferred User Zone List) .....	83
26	5.2.51	<i>EF<sub>MAXPUZL</sub></i> (Maximum PUZL).....	84
27	5.2.52	<i>EF<sub>MECRP</sub></i> (ME-specific Configuration Request Parameters) .....	86
28	5.2.53	<i>EF<sub>HRPDAC</sub></i> (HRPD Access Authentication Capability Parameters).....	87
29	5.2.54	<i>EF<sub>HRPDUPP</sub></i> (HRPD Access Authentication User Profile Parameters).....	88
30	5.2.55	<i>EF<sub>CSSPR</sub></i> (CUR_SSPR_P_REV) .....	89
31	5.2.56	<i>EF<sub>ATC</sub></i> (Access Terminal Class) .....	90
32	5.2.57	<i>EF<sub>EPRL</sub></i> (Extended Preferred Roaming List) .....	91
33	5.2.58	<i>EF<sub>BCSMScfg</sub></i> (Broadcast Short Message Configuration) .....	92
34	5.2.59	<i>EF<sub>BCSMSpref</sub></i> (Broadcast Short Message Preference).....	93
35	5.2.60	<i>EF<sub>BCSMStable</sub></i> (Broadcast Short Message Table).....	94
36	5.2.61	<i>EF<sub>BCSMSP</sub></i> (Broadcast Short Message Parameter) .....	96
37	5.2.62	<i>EF<sub>BAKPARA</sub></i> (Currently used BAK Parameters).....	97
38	5.2.63	<i>EF<sub>UpBAKPARA</sub></i> (Updated BAK Parameters).....	99
39	5.2.64	<i>EF<sub>MMSN</sub></i> (MMS Notification) .....	101
40	5.2.65	<i>EF<sub>EXT8</sub></i> (Extension 8) .....	104
41	5.2.66	<i>EF<sub>MMSICP</sub></i> (MMS Issuer Connectivity Parameters) .....	105
42	5.2.67	<i>EF<sub>MMSUP</sub></i> (MMS User Preferences).....	109
43	5.2.68	<i>EF<sub>MMSUCP</sub></i> (MMS User Connectivity Parameters).....	111
44	5.2.69	<i>EF<sub>AuthCapability</sub></i> (Authentication Capability).....	112
45	5.2.70	<i>EF<sub>3GCIK</sub></i> (3G Cipher and Integrity Keys) .....	114
46	5.2.71	<i>EF<sub>DCK</sub></i> (De-Personalization Control Keys) .....	115

1	5.2.72	<i>EF<sub>GID1</sub></i> (Group Identifier Level 1) .....	116
2	5.2.73	<i>EF<sub>GID2</sub></i> (Group Identifier Level 2) .....	117
3	5.2.74	<i>EF<sub>CDMACNL</sub></i> (CDMA Co-operative Network List) .....	118
4	5.2.75	<i>EF<sub>HOME_TAG</sub></i> (Home System Tag).....	120
5	5.2.76	<i>EF<sub>GROUP_TAG</sub></i> (Group Tag List) .....	121
6	5.2.77	<i>EF<sub>SPECIFIC_TAG</sub></i> (Specific Tag List).....	122
7	5.2.78	<i>EF<sub>CALL_PROMPT</sub></i> (Call Prompt List) .....	123
8	5.2.79	<i>EF<sub>SF_EUIMID</sub></i> (Short Form EUIMID) .....	124
9	5.2.80	<i>EF<sub>EST</sub></i> (Enabled Service Table).....	125
10	5.2.81	<i>EF<sub>HiddenKey</sub></i> (Key for hidden phone book entries) .....	127
11	5.2.82	<i>EF<sub>LCSVER</sub></i> (LCS Protocol Version).....	128
12	5.2.83	<i>EF<sub>LCSCP</sub></i> (LCS Connectivity Parameter) .....	129
13	5.2.84	<i>EF<sub>SDN</sub></i> (Service Dialing Numbers).....	130
14	5.2.85	<i>EF<sub>EXT2</sub></i> (Extension2) .....	131
15	5.2.86	<i>EF<sub>EXT3</sub></i> (Extension3) .....	132
16	5.2.87	<i>EF<sub>ICI</sub></i> (Incoming Call Information).....	133
17	5.2.88	<i>EF<sub>OCI</sub></i> (Outgoing Call Information).....	139
18	5.2.89	<i>EF<sub>EXT5</sub></i> (Extension 5) .....	141
19	5.2.90	<i>EF<sub>CCP2</sub></i> (Capability Configuration Parameters 2).....	142
20	5.2.91	Reserved .....	143
21	5.2.92	<i>EF<sub>AppLabels</sub></i> (Application Labels).....	144
22	5.2.93	<i>EF<sub>Model</sub></i> (Device Model Information) .....	146
23	5.2.94	<i>EF<sub>RC</sub></i> (Root Certificates).....	147
24	5.2.95	<i>EF<sub>SMSCAP</sub></i> (SMS Capabilities).....	150
25	5.2.96	<i>EF<sub>MIPFlags</sub></i> (Mobile IP Flags) .....	152
26	5.2.97	<i>EF<sub>3GPDUPPExt</sub></i> (3GPD User Profile Parameters Extension) .....	153
27	5.2.98	Reserved .....	156
28	5.2.99	<i>EF<sub>IPv6CAP</sub></i> (IPv6 Capabilities).....	157
29	5.2.100	<i>EF<sub>TCPConfig</sub></i> (TCP Configurations).....	161
30	5.2.101	<i>EF<sub>DGC</sub></i> (Data Generic Configurations).....	162
31	5.2.102	<i>EF<sub>WAPBrowserCP</sub></i> (WAP Browser Connectivity Parameters) .....	163
32	5.2.103	<i>EF<sub>WAPBrowserBM</sub></i> (WAP Browser Bookmarks) .....	165
33	5.2.104	<i>EF<sub>MMSConfig</sub></i> (MMS Configuration) .....	167
34	5.2.105	<i>EF<sub>JDL</sub></i> (Java Download URL) .....	169
35	5.2.106	<i>EF<sub>ARR</sub></i> (Access Rule Reference) .....	170
36	5.3	CONTENTS OF DFS AT THE CSIM ADF (APPLICATION DF) LEVEL .....	170
37	5.3.1	Contents of files at the DF <sub>PHONEBOOK</sub> level .....	170
38	5.4	CONTENTS OF EFS AT THE DF <sub>TELECOM</sub> LEVEL .....	171
39	5.4.1	<i>EF<sub>ADN</sub></i> (Abbreviated dialing numbers) .....	171
40	5.4.2	<i>EF<sub>EXT1</sub></i> (Extension 1) .....	171
41	5.4.3	<i>EF<sub>ECCP</sub></i> , <i>EF<sub>CCP1</sub></i> , <i>EF<sub>CCP</sub></i> .....	171
42	5.4.4	<i>EF<sub>SUME</sub></i> (Set Up Menu Elements).....	171
43	5.4.5	<i>EF<sub>ARR</sub></i> (Access Rule Reference) .....	171
44	5.5	CONTENTS OF DFS AT THE DF <sub>TELECOM</sub> LEVEL .....	172
45	5.5.1	Contents of files at the DF <sub>GRAPHICS</sub> level.....	172
46	5.5.2	Contents of files at the DF <sub>PHONEBOOK</sub> under the DF <sub>TELECOM</sub> .....	172

1	5.5.3	<i>Contents of files at the DF<sub>MULTIMEDIA</sub> level</i>	172
2	5.5.4	<i>Contents of files at the DF<sub>MMSS</sub> level</i>	172
3	<b>6.</b>	<b>INTERWORKING OF R-UIM &amp; CSIM APPLICATION ON A UICC</b>	<b>173</b>
4	6.1	FILE MAPPING	173
5	6.2	RESERVED	173
6	6.3	ACCESS CONDITIONS	173
7	6.4	RESERVED	173
8	<b>7.</b>	<b>APPLICATION PROTOCOL</b>	<b>174</b>
9	7.1	CSIM MANAGEMENT PROCEDURES	174
10	7.1.1	<i>Initialization</i>	174
11	7.1.2	<i>Session Termination</i>	176
12	7.1.3	<i>CSIM Application Closure</i>	176
13	7.1.4	<i>Emergency call codes request</i>	176
14	7.1.5	<i>Preferred Language request</i>	176
15	7.1.6	<i>Administrative Data request</i>	176
16	7.1.7	<i>The ME performs the reading procedure with EF<sub>AD</sub> and processes the data as appropriate</i>	
17		<i>Service Table request</i>	176
18	7.1.8	<i>UICC Presence Detection</i>	176
19	7.1.9	<i>Enabled Services Table request</i>	177
20	7.1.10	<i>OTASP/OTAPA Features request</i>	177
21	7.1.11	<i>RUIMID request</i>	177
22	7.1.12	<i>ESN_MEID_ME update</i>	177
23	7.1.13	<i>ME-specific Configuration Request update</i>	177
24	7.1.14	<i>Service Preferences request</i>	177
25	7.1.15	<i>IMSI request</i>	177
26	7.1.16	<i>Access Overload Class information request</i>	177
27	7.1.17	<i>PRL and EPRL request</i>	177
28	7.1.18	<i>PUZL request</i>	178
29	7.1.19	<i>3GPD Operation Capabilities update</i>	178
30	7.1.20	<i>Device Model update</i>	178
31	7.1.21	<i>Multimode Location Association Priority List (MLPL) request</i>	178
32	7.1.22	<i>Multimode System Priority List (MSPL) request</i>	178
33	7.2	CSIM SECURITY RELATED PROCEDURES	178
34	7.2.1	<i>AKA (3GCIK)</i>	178
35	7.3	SUBSCRIPTION RELATED PROCEDURES	178
36	7.3.1	<i>Phone book procedure</i>	178
37	7.3.2	<i>Dialing numbers</i>	179
38	7.3.3	<i>Short Message</i>	181
39	7.3.4	<i>Void</i>	182
40	7.3.5	<i>Group Identifier level 1</i>	182
41	7.3.6	<i>Group Identifier level 2</i>	182
42	7.3.7	<i>Service provider name</i>	182
43	7.3.8	<i>Depersonalisation Control Keys</i>	182
44	7.3.9	<i>Co-operative Network List</i>	182

1	7.3.10	MMS Notifications .....	182
2	7.3.11	MMS Issuer Connectivity Parameters .....	183
3	7.3.12	MMS User Preferences .....	183
4	7.3.13	MMS User Connectivity Parameters .....	184
5	7.3.14	Multimedia Message Storage .....	184
6	7.4	CCAT RELATED PROCEDURES .....	184
7	7.4.1	Data Download via SMS-PP .....	184
8	7.4.2	Data Download via SMS Broadcast .....	185
9	7.4.3	Call Control by CSIM .....	185
10	7.4.4	Image Request .....	185
11	<b>8.</b>	<b>STRUCTURE OF COMMANDS AND RESPONSES .....</b>	<b>186</b>
12	8.1	COMMAND APDU STRUCTURE .....	186
13	8.1.1	Coding of Class byte .....	186
14	8.1.2	Coding of Instruction byte .....	186
15	8.1.3	Coding of Parameter bytes .....	188
16	8.1.4	Coding of Lc bytes .....	188
17	8.1.5	Coding of Data part .....	188
18	8.1.6	Coding of Le bytes .....	189
19	8.2	RESPONSE APDU STRUCTURE .....	189
20	<b>9.</b>	<b>COMMANDS .....</b>	<b>190</b>
21	9.1	GENERIC COMMANDS .....	190
22	9.2	CAT COMMANDS .....	190
23	9.3	DATA ORIENTED COMMANDS .....	190
24	9.4	CSIM COMMANDS .....	190
25	9.4.1	Security-related Commands .....	190
26	9.4.2	OTASP/OTAPA-related Commands .....	192
27	9.4.3	ESN Management Commands .....	199
28	9.4.4	Packet Data security-related Commands .....	201
29	9.4.5	BCMCS-related Commands .....	201
30	9.4.6	Application Authentication Commands .....	202
31	9.4.7	AKA-related Commands .....	202
32	9.4.8	LCS-related Commands .....	203
33	<b>10.</b>	<b>DESCRIPTION OF SERVICES-RELATED PROCEDURE .....</b>	<b>208</b>
34	10.1	IP-BASED LOCATION SERVICES PROCEDURES [50] .....	208
35	10.1.1	Functionalities of CSIM and ME .....	208
36	10.1.2	Key Management .....	209
37	<b>ANNEX A (INFORMATIVE): R-UIM/CSIM FILE MAPPING TABLE .....</b>		<b>210</b>
38	<b>ANNEX B (NORMATIVE): LIST OF SFI VALUES .....</b>		<b>211</b>
39	<b>ANNEX C (INFORMATIVE): CSIM APPLICATION SESSION ACTIVATION/TERMINATION .....</b>		<b>212</b>
40	<b>ANNEX D (NORMATIVE): TLS-RELATED TAG VALUES .....</b>		<b>213</b>
41	<b>ANNEX E (INFORMATIVE): SUGGESTED CONTENTS OF THE EFS AT PRE-PERSONALIZATION</b>		<b>214</b>

1 **ANNEX F (NORMATIVE): RESERVATION OF FILE IDENTIFIERS .....220**

**Figures**

1  
2  
3  
4

**Figure 1 CSIM Application Session Activation Procedures ..... 212**  
**Figure 2 CSIM Application Session Termination Procedures ..... 212**

**Tables**

1  
2  
3  
4  
5

**Table 1** Coding of CLA, INS, P1 and P2 Bytes of the CSIM Commands..... 186

**Table 2** Coding of 'TLS Service Type' ..... 205

**Table 3** Summary of CSIM Files ..... 214

**1 FOREWORD**

2 This foreword is not part of this specification.

3 The present document defines the cdma2000<sup>®1</sup> (CSIM) application. This document also inherits  
4 many of the Elementary File types and other characteristics from the R-UIM specification [46].

5

---

<sup>1</sup> cdma2000<sup>®</sup> is the trademark for the technical nomenclature for certain specifications and standards of the Organizational Partners (OPs) of 3GPP2. Geographically (and as of the date of publication), cdma2000<sup>®</sup> is a registered trademark of the Telecommunications Industry Association (TIA-USA) in the United States.

1 This page intentionally left blank.

## 1. INTRODUCTION

This specification defines the cdma2000 (CSIM) application. This application resides on the UICC, an IC card specified in [45]. In particular, [45] specifies the application independent properties of the UICC/terminal interface such as the physical characteristics and the logical structure.

### 1.1 Scope

The present document defines the cdma2000 application for cdma2000 network operation.

The present document specifies:

- Specific command parameters;
- File structures;
- Security functions;
- Interworking with other Applications (ISIM, USIM, etc.) on UICC
- Application protocol to be used on the interface between UICC (cdma2000 application) and ME.

This is to ensure interoperability between a CSIM and an ME independently of the respective manufacturer, card issuer or operator.

The present document does not define any aspects related to the administrative management phase of the cdma2000 application. Any internal technical realization of either the cdma2000 application or the ME is only specified where these are reflected over the interface. The present document does not specify any of the security algorithms that may be used.

### 1.2 Requirements Language

“Shall” and “shall not” identify requirements to be followed strictly to conform to this document and from which no deviation is permitted. “Should” and “should not” indicate that one of several possibilities is recommended as particularly suitable, without mentioning or excluding others, that a certain course of action is preferred but not necessarily required, or that (in the negative form) a certain possibility or course of action is discouraged but not prohibited. “May” and “need not” indicate a course of action permissible within the limits of the document. “Can” and “cannot” are used for statements of possibility and capability, whether material, physical or causal.

### 1.3 References

The following standards are referenced in this text. At the time of publication, the editions indicated were valid. All standards are subject to revision, and parties to agreements based upon this document are encouraged to investigate the possibility of applying the most recent

- 1 editions of the standards indicated below. ANSI and TIA maintain registers of currently valid
- 2 national standards published by them.

**1.3.1 Normative References**

1. 3GPP2 C.S0001-E v3.0, *Introduction to cdma2000 Spread Spectrum Systems*, June 2011.
2. Reserved.
3. Reserved.
4. Reserved.
5. 3GPP2 C.S0005-E v3.0, *Upper Layer (Layer 3) Signaling Standard for cdma2000 Spread Spectrum Systems*, June 2011.
6. Reserved.
7. 3GPP2 C.S0016-D v2.0, *Over-the-Air Service Provisioning of Mobile Stations in Spread Spectrum Systems*, April 2012.
8. C.S0015-B v2.0, *Short Message Service for Spread Spectrum Systems*, October 2005.
9. ITU-T Recommendation E.212, "Identification Plan for Land Mobile Stations", May 2008.
10. Reserved.
11. Reserved.
12. Reserved.
13. Reserved.
14. TIA-95-B, *Mobile Station - Base Station Compatibility Standard for Wideband Spread Cellular Systems*, October 2004.
15. 3GPP2 X.S0004-E v9.0, *Mobile Application Part*, June 2009.
16. Reserved.
17. 3GPP TS 51.011 V4.15.0, *Specification of the Subscriber Identity Module-Mobile Equipment (SIM-ME) Interface*, June 2005.
18. ETSI TS 102 221 V10.0.0, *Smart cards; UICC-Terminal Interface; Physical and logical Characteristics*, December 2011.
19. Reserved.
20. Reserved.
21. Reserved.
22. Reserved.
23. 3GPP2 X.S0011-E v1.0, *cdma2000 Wireless IP Network Standard*, November 2009.

- 1 24. Reserved.
- 2 25. Reserved.
- 3 26. Reserved.
- 4 27. Reserved.
- 5 28. 3GPP2 C.S0024-C v2.0, *cdma2000 High Rate Packet Data Air Interface Specification*, July  
6 2011.
- 7 29. Reserved.
- 8 30. 3GPP TS 31.102 V11.0.0, *Characteristics of the Universal Subscriber Identity Module*  
9 *(USIM) application*, October 2010.
- 10 31. Reserved.
- 11 32. Reserved.
- 12 33. Reserved.
- 13 34. Reserved.
- 14 35. Reserved.
- 15 36. 3GPP2 S.S0083-A v1.0, *Broadcast-Multicast Service Security Framework*, September  
16 2004.
- 17 37. 3GPP2 X.S0016-200-A v1.0, *MMS Stage-2, Functional Description*, February 2006.
- 18 38. 3GPP TS 23.038 V9.1.1, *Alphabets and language-specific information*, February 2010.
- 19 39. 3GPP2 X.S0016-310 v2.0, *MMS MM1 Stage-3 Using OMA/WAP*, July 2004.
- 20 40. 3GPP2 X.S0016-311-0 v1.0, *MMS MM1 Stage-3 Using M-IMAP for message submission*  
21 *and retrieval*, May 2003.
- 22 41. 3GPP2 X.S0016-312-0 v1.0, *MMS MM1 Stage-3 Using SIP*, July 2004.
- 23 42. Reserved.
- 24 43. Reserved.
- 25 44. 3GPP2 C.S0068-0 v1.0, *ME Personalization*, June 2006.
- 26 45. 3GPP2 C.S0074-B v1.0, *UICC-Terminal Interface Physical and Logical Characteristics for*  
27 *cdma2000 Spread Spectrum Systems*, July 2014.
- 28 46. 3GPP2 C.S0023-D v2.0, *Removable User Identity Module for Spread Spectrum Systems*,  
29 December 2011.
- 30 47. 3GPP2 C.S0035-A v2.0, *CDMA Card Application Toolkit (CCAT)*, August 2007.

- 1 48. ETSI TS 101 220 V11.0.0, *Smart cards; ETSI numbering system for telecommunication*  
2 *application providers*, June 2011.
- 3 49. Reserved.
- 4 50. S.S0110-0 v1.0, *IP-based Location Services Security Framework*, March 2006.
- 5 51. Reserved.
- 6 52. Reserved.
- 7 53. ISO/IEC 7816-4, *Identification cards - Integrated circuit cards, Part 4: Organization,*  
8 *security and commands for interchange*, January 2005.
- 9 54. ETSI TS 102 222 V7.1.0, *Administrative commands for telecommunications applications*,  
10 February 2007.
- 11 55. Reserved.
- 12 56. Reserved.
- 13 57. Reserved.
- 14 58. ITU E.118 The international telecommunication charge card, May, 2006.
- 15 59. ITU X.509, *Public-key and attribute certificate frameworks*, November 2008.
- 16 60. ITU X.690, *ASN.1 encoding rules: Specification of Basic Encoding Rules (BER), Canonical*  
17 *Encoding Rules (CER) and Distinguished Encoding Rules (DER)*, November 2008.
- 18 61. IETF RFC 2315, *PKCS #7: Cryptographic Message Syntax Version 1.5*, March 1998.
- 19 62. RSA PKCS #12 v1.0, *Personal Information Exchange Syntax*, March 1998.
- 20 63. IETF RFC 4489, *A Method for Generating Link-Scoped IPv6 Multicast Addresses*, April  
21 2006.
- 22 64. IETF RFC 1738, *Uniform Resource Locators (URL)*, December 1994.
- 23 65. 3GPP2 C.S0017-012-A v2.0, *Data Service Options for Spread Spectrum Systems: Service*  
24 *Options 33 and 66*, June 2006.
- 25 66. ISO/IEC 7816-5, *Identification cards -- Integrated circuit cards -- Part 5: Registration of*  
26 *application providers*, December 2004.
- 27 67. IETF RFC 3629, *UTF-8, a transformation format of ISO 10646*. November 2003.
- 28 68. 3GPP2 C.S0057-E v1.0, *Band Class Specification for cdma2000 Spread Spectrum*  
29 *Systems*, October 2010.
- 30 69. IETF RFC 2195. *IMAP/POP AUTHorize Extension for Simple Challenge/Response*.  
31 September 1997.
- 32 70. IETF RFC 2617. *HTTP Authentication: Basic and Digest Access Authentication*. June  
33 1999.

- 1 71. IETF RFC 3310. *Hypertext Transfer Protocol (HTTP) Digest Authentication Using*  
2 *Authentication and Key Agreement (AKA)*. September 2002.
- 3 72. IETF RFC 2831. *Using Digest Authentication as a SASL Mechanism*. May 2000.
- 4 73. IETF RFC 2444. *The One-Time-Password SASL Mechanism*. October 1998.
- 5 74. IETF RFC 2222. *Simple Authentication and Security Layer (SASL)*. October 1997.
- 6 75. IETF RFC 2002. *IP Mobility Support*. October 1996.

### 7 **1.3.2 Informative References**

- 8 1. 3GPP2 C.R1001-G v1.0, *Administration of Parameter Value Assignments for cdma2000*  
9 *Wideband Spread Spectrum Standards*, June 2009.
- 10 2. 3GPP TS 31.101, *UICC-Terminal Interface, Physical and Logical Characteristics*.
- 11 3. 3GPP TS 23.140, *Multimedia Messaging Service (MMS); Functional description; stage 2*.

1 **2. VOID**

2

1 **3. VOID**

#### 4. DEFINITIONS, SYMBOLS, ABBREVIATIONS AND CODING CONVENTIONS

For the purposes of the present document, the following terms and definitions apply:

**AID.** ISO/IEC 7816 Application Identifier. See [48], [53] and [66].

**Card Session.** See [17].

**CDMA Session.** That part of the *Card Session* dedicated to the CDMA operation.

**CSIM.** cdma2000 Subscriber Identity Module. cdma2000 Application residing on the UICC, an IC card specified in [45].

**ECC (Emergency Call Code).** A number, that when dialed by the user, is to be treated as an emergency call.

**ESN (Electronic Serial Number).** A 32-bit number that may be the ESN\_ME or UIM\_ID.

**ESN\_ME.** A 32-bit number that may be a unique value assigned to a mobile station or a non-unique value derived from the MEID\_ME (pESN).

**EUIMID.** Expanded UIMID. SF\_EUIMID or LF\_EUIMID.

**ICCID.** The International Charge Card Identifier. See [58].

**LCS.** Location services.

**LCS Root Key.** LCS related parameter. See [50].

**LF\_EUIMID.** Long form EUIMID, the ICCID.

**MEID (Mobile Equipment Identifier).** A 56-bit number (14 hexadecimal digits) that may be the MEID\_ME or SF\_EUIMID.

**MEID\_ME.** A 56-bit number uniquely assigned to a mobile station by a manufacturer.

**MMSS.** Multi-Mode System Selection. See [7].

**PIX.** Proprietary application Identifier eXtension. See [48], [53] and [66].

**pESN.** A 32-bit number derived from MEID and used in place of ESN. See section 2.3.2.2.1 of [5].

**pUIMID.** A 32-bit number derived from EUIMID and used in place of UIMID. See section 5.2.17 (EFRUIMID).

**RID.** Registered Application Provider Identifier. See [48], [53] and [66].

**R-UIM.** Removable User Identity Module residing on a Non-UICC based platform, as specified in [46].

**SF\_EUIMID.** A 56-bit number uniquely assigned to an R-UIM using the same format as MEID\_ME and assigned from the same numbering space.

**S-SAFE.** Secure Store-And-Forward-Encapsulation. LCS related parameter. See [50].

1 **TLS.** Transport Layer Security.

2 **UI.** User Interface.

3 **UIMID.** A 32-bit electronic identification number unique to an R-UIM or a non-unique value  
4 derived from the EUIMID (pUIMID).

5 All other definitions, symbols, abbreviations applicable to the R-UIM specified in [46] and UICC  
6 specified in [45] are applicable here.

## 7 **4.1 Coding Conventions**

8 All unused, allocated memory shall be set to zero unless otherwise specified. RFU bits shall  
9 be set to zero and may be used in the future for additional parameters. Reserved bits shall  
10 be set to zero unless otherwise specified and shall not be used in the future for additional  
11 parameters. The ME shall ignore the state of all RFU and Reserved bits.

12 Single quotes indicate binary or hexadecimal values (e.g. '00000001' or 'A0'). Valid elements  
13 for hexadecimal values are the digits '0' to '9' and 'A' to 'F' (representing the values 10  
14 through 15).

### 15 **4.1.1 CSIM Status Codes**

16 Status codes sent by the CSIM to an ME via octets SW1 and SW2 are defined in [18] except  
17 for SW1='98', SW2='34' (originally defined in [17]) which means, "Error, out of sequence".

## 18 **4.2 Parameters Stored Temporarily in the CSIM**

19 The following parameters with subscript "s" indicate a value stored temporarily in the  
20 CSIM:

21 **NAM\_LOCK<sub>s</sub>** – A network controlled status of the SPASM protection of the active NAM  
22 for the subsequent OTAPA session – temporarily stored in the CSIM.

23 **SPC<sub>S</sub>** – Service Programming Code temporarily stored in the CSIM if the Service  
24 Programming Lock feature is supported by the CSIM.

25 **SSD<sub>S</sub>** – A secret 128-bit pattern for the Shared Secret Data temporarily stored in the  
26 CSIM.

## 5. FILES

This section specifies the EFs for the CDMA operation defining access conditions, contents and coding.

A file is associated with attributes that depending of the file type indicates how data is to be accessed e.g. file size, record length etc. Although in the present document some files and data items stored in a file are indicated as having a fixed length; when reading such structures the ME shall derive the length of the data item from the attributes provided in the file information i.e. not use the fixed value specified for the file in the present document. Although the ME is able to read the entire structure it should only use those elements in the data item which is recognized by the ME.

For any EF, if the SFI (Short (elementary) Form Indicator) is not indicated in the description of the file, then it is not allowed to assign an SFI. If in the description of the file an SFI value is indicated, then the file shall support SFI. The SFI value shall be assigned by the card issuer. It is mandatory for EFs stating an SFI value ('YY') in the description of their structure to provide an SFI. For files where in the file description the SFI is indicated as 'Optional', then the file may support an SFI.

References [1] and [14] store parameters in several different types of memory.

- Variables stored in permanent memory use the subscript "p".
- Variables stored in semi-permanent memory use the subscript "s-p".
- Variables temporarily stored (including those parameters defined in Sec. 3.2 which use the subscript s).

### 5.1 Contents of files at the MF level

There are four application independent EFs at the Master File (MF) level as specified in [45], i.e.: EF<sub>ICCID</sub>, EF<sub>DIR</sub>, EF<sub>PL</sub> and EF<sub>FARR</sub>.

EF<sub>DIR</sub> stores the AID of CSIM, defined in section 4 of [48]. The AID is composed of the RID code 0xA000000343 ('3GPP2') and the PIX code, of which the first four digits are the 3G App Code 0x1002 indicating the "3GPP2 CSIM" application, defined in Annex M of [48]. The remaining digits should be formatted according to Annex F of [48].

Multiple CSIM applications can be distinguished by using different values in digits 21 and 22 of AID for each application.

#### 5.1.1 EF<sub>ICCID</sub> (ICC Identification)

EF<sub>ICCID</sub> is as defined in [18] with the following restrictions:

- This EF shall contain 18 digits of the actual ICCID followed by the check digit and a single 0xF filler digit.
- The ICCID shall be globally unique, using an Issuer Identifier Number registered with the ITU-T as specified in [58].
- If the long form of the EUIMID is chosen, the ICCID is the LF\_EUIMID.

1 **5.2 Contents of files at the CSIM ADF (Application DF) level**

2 **5.2.1 EF<sub>COUNT</sub> (Call Count)**

3 This EF stores the value of Call Count, COUNTs-p.

4

Identifier: '6F21'		Structure: cyclic		Mandatory	
Record Length: 2 bytes			Update activity: high		
Access Conditions:					
READ		PIN			
UPDATE		PIN			
INCREASE		PIN			
INVALIDATE		ADM			
REHABILITATE		ADM			
Bytes	Description			M/O	Length
1 – 2	COUNTs-p			M	2 bytes

5  
6 COUNTs-p is contained in the least significant 6 bits of the two-byte field.

7  
8 Coding:

9 Byte 1:

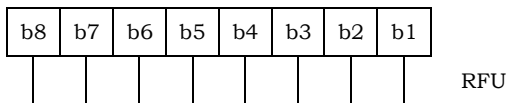

10  
11 Byte 2:

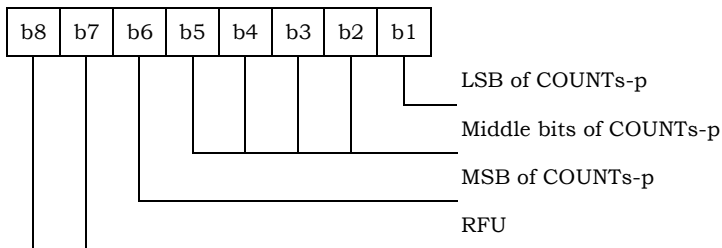

1 **5.2.2 EF<sub>IMSI\_M</sub> (IMSI\_M)**

2 This EF stores the five components of IMSI\_M.

3

Identifier: '6F22'		Structure: transparent		Mandatory	
SFI: '04'					
File size: 10 bytes			Update activity: low		
Access Conditions:					
READ		PIN			
UPDATE		ADM			
INVALIDATE		ADM			
REHABILITATE		PIN			
Bytes	Description	M/O	Length		
1	IMSI_M_CLASS <sub>p</sub>	M	1 byte		
2 – 3	IMSI_M_S2 from IMSI_M_S <sub>p</sub>	M	2 bytes		
4 – 6	IMSI_M_S1 from IMSI_M_S <sub>p</sub>	M	3 bytes		
7	IMSI_M_11_12 <sub>p</sub>	M	1 byte		
8	IMSI_M_PROGRAMMED/ IMSI_M_ADDR_NUM <sub>p</sub>	M	1 byte		
9 –10	MCC_M <sub>p</sub>	M	2 bytes		

4

5 IMSI\_M\_CLASS<sub>p</sub> - Class assignment of the IMSI\_M.

6 IMSI\_M\_ADDR\_NUM<sub>p</sub> - Number of IMSI\_M address digits.

7 MCC\_M<sub>p</sub> - Mobile country code.

8 IMSI\_M\_11\_12<sub>p</sub> - 11th and 12th digits of the IMSI\_M.

9 IMSI\_M\_S<sub>p</sub> - The least significant 10 digits of the IMSI\_M.

10

11 Coding:

12 Byte 1:

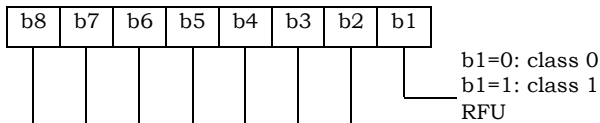

13

14 Byte 2, byte 3, byte 4, byte 5 and byte 6 are encoded as described in Section 2.3.1.1 of [5] and  
 15 Section 6.3.1.1 of [14], “Encoding of IMSI\_M\_S and IMSI\_T\_S”. IMSI\_M\_S2 contains the most  
 16 significant digits of IMSI\_M\_S and IMSI\_M\_S1 contains the least significant digits of IMSI\_M\_S as  
 17 described in Figure 2.3.1.-2 of [5] and Figure 6.3.1-2 of [14].

1  
2  
3  
4  
5  
6  
7  
8  
9  
10  
11  
12  
13  
14  
15  
16  
17  
18  
19  
20

Byte 2:

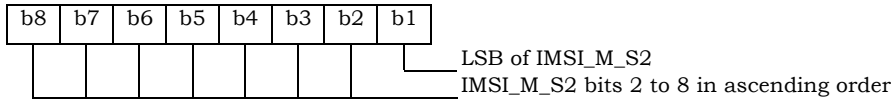

Byte 3:

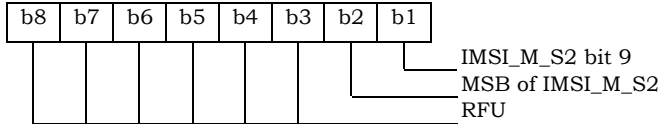

Byte 4:

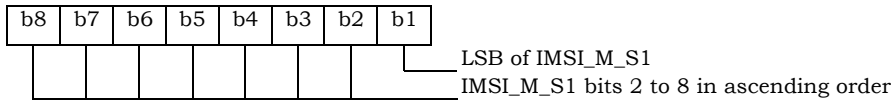

Byte 5:



Byte 6:

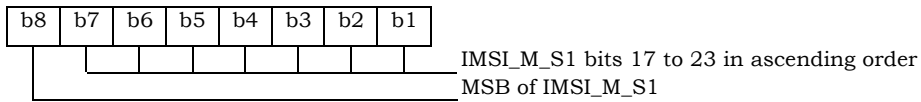

Byte 7 is encoded as described in Section 2.3.1.2 of [5] and Section 6.3.1.2 of [14], “Encoding of IMSI\_M\_11\_12 and IMSI\_T\_11\_12”.

Byte 7:

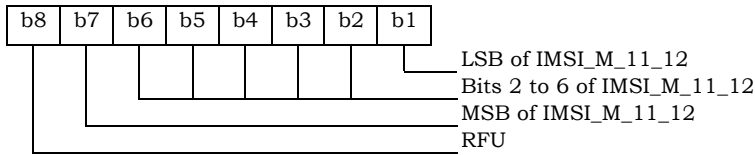

Byte 8 is the binary equivalent of the IMSI\_M\_ADDR\_NUM, as described in Section 2.3.1 of [5] and Section 6.3.1 or [14], “Mobile Station Identification Number”.

Byte 8:

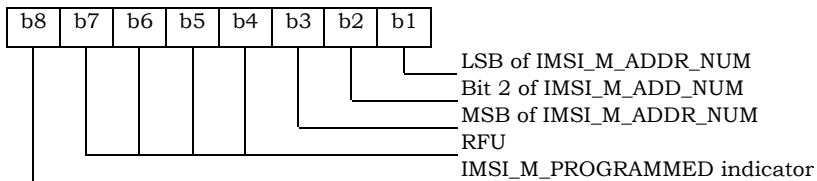

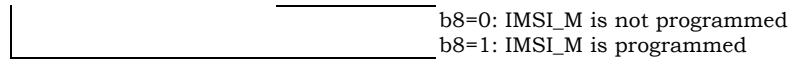

1  
2  
3  
4  
5  
6  
7  
8  
9  
10  
11  
12  
13  
14  
15  
16  
17  
18  
19  
20  
21  
22

IMSI\_M\_PROGRAMMED shall be set to ‘1’ if an IMSI\_M is programmed otherwise it shall be set to ‘0’. If OTASP is used to update this EF, see section 8.4.2.2 COMMIT. See [5] or [14] for details on IMSI\_M programming.

Byte 9 and byte 10 are encoded as described in Section 2.3.1.3 of [5] and Section 6.3.1.3 of [14], “Encoding of the MCC\_M and MCC\_T”.

Byte 9:

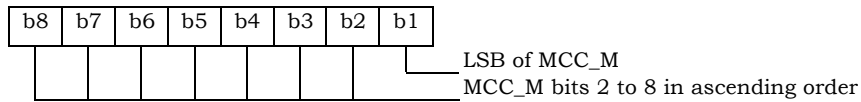

Byte 10:

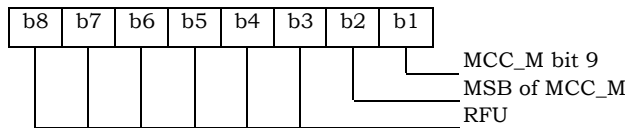

For CSIM applications in systems that comply with [5] or [14], the parameter “MIN” is stored in EF<sub>IMSI\_M</sub>. For these instances, the 10 bits of “MIN2” are stored in bytes 2 and 3, with the coding shown above, while the 24 bits of “MIN1” are stored in bytes 4, 5, and 6.

The selection of IMSI\_M or IMSI\_T for use in the authentication process shall be in accordance with [14] Section 6.3.12.1 and [5] Section 2.3.12.1, which stipulate that the “MIN” portion of IMSI\_M shall be used as an input parameter of the authentication calculation if IMSI\_M is programmed and that a 32-bit subset of IMSI\_T shall be used if only IMSI\_T has been programmed.

1 **5.2.3 EF<sub>IMSI\_T</sub> (IMSI\_T)**

2 This EF stores the five components of IMSI\_T.

3

Identifier: '6F23'		Structure: transparent		Mandatory	
SFI: '05'					
File size: 10 bytes			Update activity: low		
Access Conditions:					
READ		PIN			
UPDATE		ADM			
INVALIDATE		ADM			
REHABILITATE		PIN			
Bytes	Description	M/O	Length		
1	IMSI_T_CLASS <sub>p</sub>	M	1 byte		
2 – 3	IMSI_T_S2 from IMSI_T_S <sub>p</sub>	M	2 bytes		
4 – 6	IMSI_T_S1 from IMSI_T_S <sub>p</sub>	M	3 bytes		
7	IMSI_T_11_12 <sub>p</sub>	M	1 byte		
8	IMSI_T_PROGRAMMED/ IMSI_T_ADDR_NUM <sub>p</sub>	M	1 byte		
9 –10	MCC_T <sub>p</sub>	M	2 bytes		

4

5 All byte descriptions, encodings and reference sections in [5] and [14] are identical to those  
6 described in Section 5.2.2 EF<sub>IMSI\_M</sub>, except that all references to “IMSI\_M” shall apply to “IMSI\_T”.

7 EF<sub>IMSI\_T</sub> is not used to store a MIN.

8

1 **5.2.4 EF<sub>TMSI</sub> (TMSI)**

2 This EF stores the Temporary Mobile Station Identity (TMSI). TMSI is assigned by the serving  
 3 network and consists of 4 components, i.e.: ASSIGNING\_TMSI\_ZONE\_LEN<sub>s-p</sub>,  
 4 ASSIGNING\_TMSI\_ZONE<sub>s-p</sub>, TMSI\_CODE<sub>s-p</sub>, and TMSI\_EXP\_TIME<sub>s-p</sub>.

5

Identifier: '6F24'		Structure: transparent		Mandatory	
SFI: '06'					
File size: 16 bytes			Update activity: high		
Access Conditions:					
READ		PIN			
UPDATE		PIN			
INVALIDATE		ADM			
REHABILITATE		PIN			
Bytes	Description			M/O	Length
1	ASSIGNING_TMSI_ZONE_LEN <sub>s-p</sub>			M	1 byte
2 – 9	ASSIGNING_TMSI_ZONE <sub>s-p</sub>			M	8 bytes
10 – 13	TMSI_CODE <sub>s-p</sub>			M	4 bytes
14 – 16	TMSI_EXP_TIME <sub>s-p</sub>			M	3 bytes

6  
 7 Coding:

8 Byte 1:

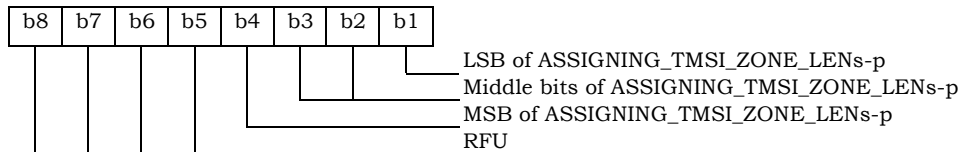

10 Bytes 2 through 9 store the (up to) 8-octet TMSI Zone as described in Section 2.3.15 of [5] and  
 11 Section 6.3.15 of [14]. These sections are entitled “Temporary Mobile Station Identity”, “Overview”  
 12 and “TMSI Assignment Memory” respectively. In each case the lowest-order octet shall be stored  
 13 in the lowest-order byte (i.e., byte 2) of each set of contiguous 8 bytes, and successively higher  
 14 octets stored in the next highest order bytes. Unused bytes shall be set to ‘00’.

15 Bytes 10 through 13 store the (2 to 4 octet) TMSI Code as described in the sections of [5] and [14]  
 16 referenced above. In each case the lowest-order octet shall be stored in the lowest-order byte (i.e.,  
 17 byte 10) of each set of contiguous 4 bytes, and successively higher octets stored in the next  
 18 highest order bytes. Unused bytes shall be set to ‘00’.

19 Bytes 14 through 16 store the TMSI Expiration Time as described in the sections of [5] and [14]  
 20 referenced above. In each case the lowest-order octet shall be stored in the lowest-order byte (i.e.,

1        byte 14) of each set of contiguous 3 bytes, and successively higher octets stored in the next  
2        highest order bytes.

1 **5.2.5 EF<sub>AH</sub> (Analog Home SID)**

2 This EF identifies the home SID when the mobile station is operating in the analog mode.

3

Identifier: '6F25'		Structure: transparent		Optional	
File size: 2 bytes			Update activity: low		
Access Conditions:					
READ		PIN			
UPDATE		PIN			
INVALIDATE		ADM			
REHABILITATE		ADM			
Bytes	Description			M/O	Length
1-2	Analog home SID (HOME_SID <sub>p</sub> )			M	2 bytes

4

5 Coding:

6

Byte 1:

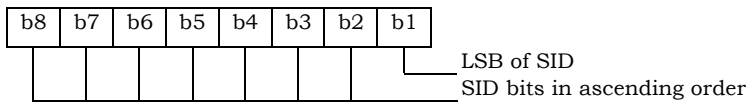

7

8

9 Byte 2:

10

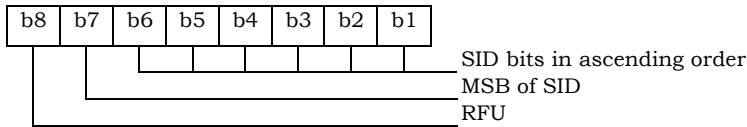

1 **5.2.6 EF<sub>AOP</sub> (Analog Operational Parameters)**

2 This EF includes the Extended Address bit (EX<sub>p</sub>), the Local Use Mark (LCM) and the Group ID  
 3 (GID) field.

4

Identifier: '6F26'		Structure: transparent		Optional	
File size: 1 byte			Update activity: low		
Access Conditions:					
READ		PIN			
UPDATE		PIN			
INVALIDATE		ADM			
REHABILITATE		ADM			
Bytes	Description			M/O	Length
1	Analog Operational Parameters (EX <sub>p</sub> , LCM, GID)			M	1 byte

5

6 Coding:

7

Byte 1:

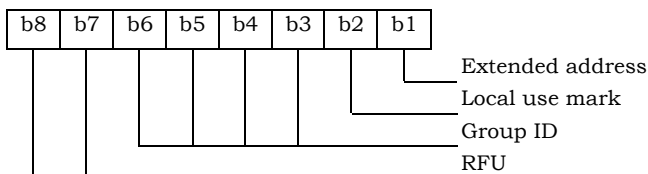

1 **5.2.7 EF<sub>ALOC</sub> (Analog Location and Registration Indicators)**

2 This EF stores parameters related to Autonomous Registration memory (NXTREGs-p and SIDs-p)  
 3 as well as the Location Area memory (LOCAIDs-p and PUREGs-p).

4

Identifier: '6F27'		Structure: transparent		Optional	
File size: 7 bytes			Update activity: high		
Access Conditions:					
READ		PIN			
UPDATE		PIN			
INVALIDATE		ADM			
REHABILITATE		ADM			
Bytes	Description			M/O	Length
1-3	NXTREG <sub>s-p</sub>			M	3 bytes
4-5	SID <sub>s-p</sub>			M	2 bytes
6-7	LOCAID <sub>s-p</sub> , PUREG <sub>s-p</sub>			M	2 bytes

5

6 Coding:

7

Byte 1:

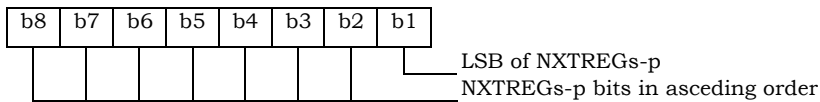

8

9 Byte 2:

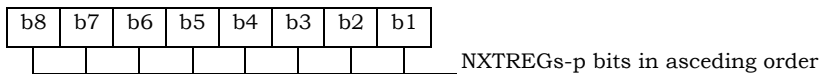

10

11 Byte 3:

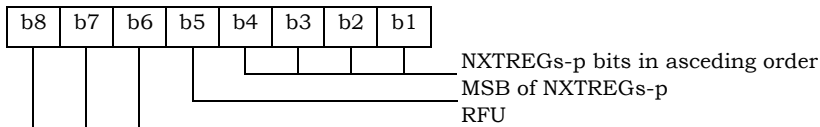

12

13 Byte 4:

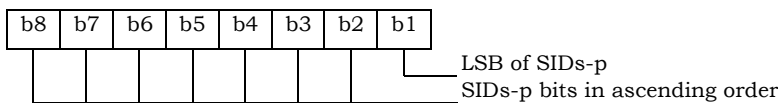

14

1

Byte 5:

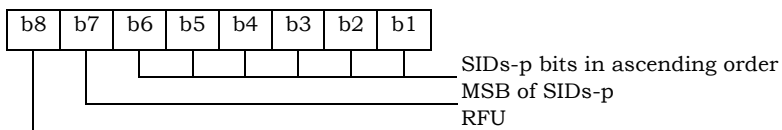

2

3

Byte 6:

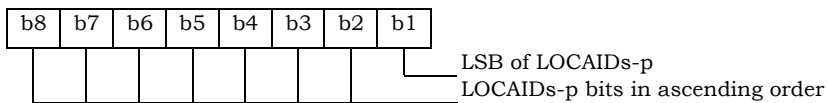

4

5

Byte 7:

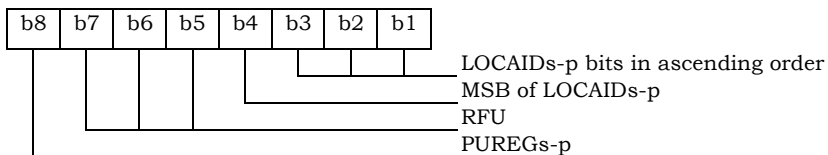

1 **5.2.8 EF<sub>CDMAHOME</sub> (CDMA Home SID, NID)**

2 This EF identifies the home SID and NID when the mobile station is operating in the CDMA mode.

3

Identifier: '6F28'	Structure: linear fixed	Mandatory	
SFI: '0C'			
Record length: 5 bytes	Update activity: low		
Access Conditions:			
READ	PIN		
UPDATE	PIN		
INVALIDATE	ADM		
REHABILITATE	ADM		
Bytes	Description	M/O	Length
1 – 2	CDMA Home SID (SID <sub>p</sub> )	M	2 bytes
3 – 4	CDMA Home NID (NID <sub>p</sub> )	M	2 bytes
5	Band Class	M	1 byte

4

5 Coding:

6

Byte 1:

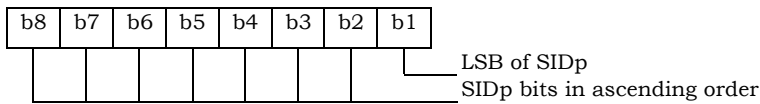

7

8

Byte 2:

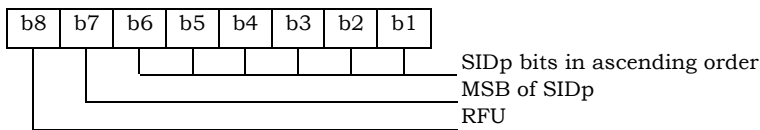

9

10

Byte 3:

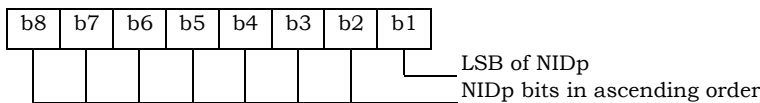

11

12

Byte 4:

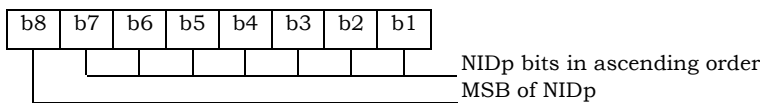

13

1

Byte 5:

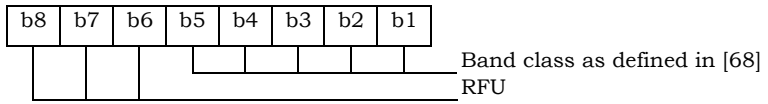

1 **5.2.9 EF<sub>ZNREGI</sub> (CDMA Zone-Based Registration Indicators)**

2 This EF stores the zone-based registration list “ZONE\_LIST”. The list includes a REG\_ZONE and a  
 3 corresponding SID, NID pair. Details are described in sections titled “Registration Memory”,  
 4 “Zone-Based Registration” and “Registration Procedures” of [5] and [14].

5

Identifier: ‘6F29’		Structure: linear fixed		Mandatory	
Record length: 8 bytes			Update activity: high		
Access Conditions:					
READ		PIN			
UPDATE		PIN			
INVALIDATE		ADM			
REHABILITATE		ADM			
Bytes	Description	M/O	Length		
1 – 2	REG_ZONE	M	2 bytes		
3 – 4	SID	M	2 bytes		
5 – 6	NID	M	2 bytes		
7 – 8	RFU	M	2 bytes		

6  
 7 Coding:

8 Byte 1:

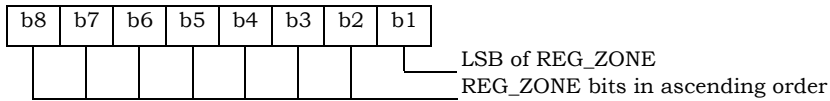

10 Byte 2:

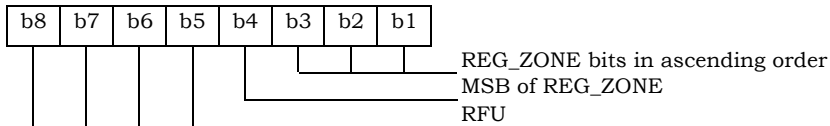

12 Byte 3:

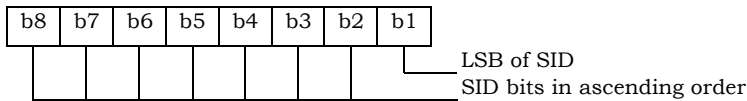

14 Byte 4:

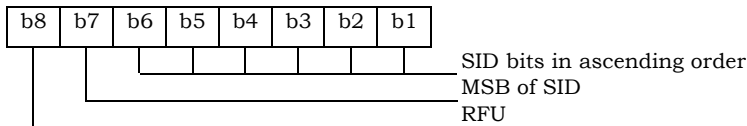

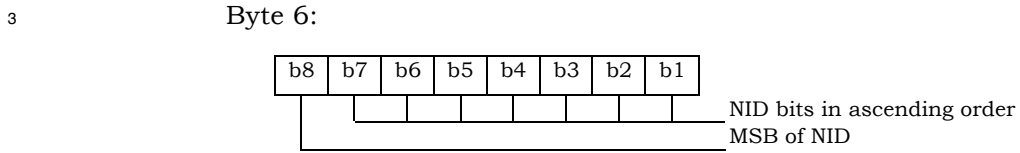
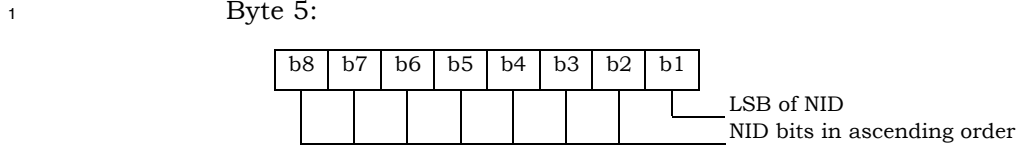

1 **5.2.10 EFSNREGI (CDMA System-Network Registration Indicators)**

2 This EF stores the SID and NID of the wireless system in which the mobile station last registered.  
 3 This is described in sections of [5] and [14] titled “Registration Memory” and “Zone-Based  
 4 Registration”, respectively.

5

Identifier: '6F2A'		Structure: transparent		Mandatory	
SFI: '0D'					
File size: 7 bytes			Update activity: high		
Access Conditions:					
READ		PIN			
UPDATE		PIN			
INVALIDATE		ADM			
REHABILITATE		ADM			
Bytes	Description	M/O	Length		
1	N, size of SID/NID list (N=1)	M	1 byte		
2 – 3	SID	M	2 bytes		
4 – 5	NID	M	2 bytes		
6 – 7	RFU	M	2 bytes		

6  
 7 Coding:

8 Byte 1:

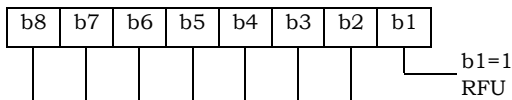

10 Byte 2:

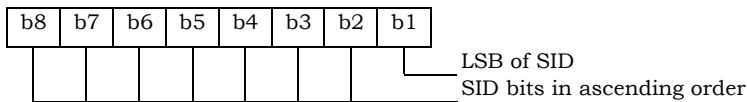

12 Byte 3:

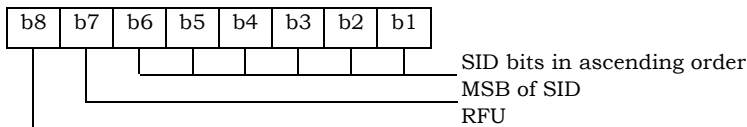

14 Byte 4:

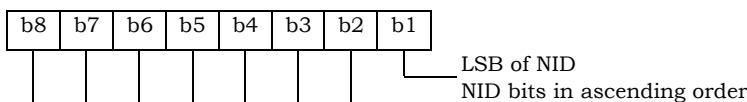

1

Byte 5:

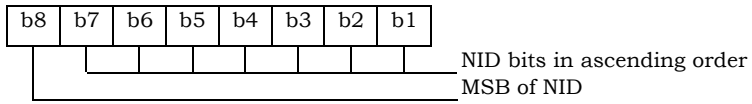

1 **5.2.11 EF<sub>DISTREGI</sub> (CDMA Distance-Based Registration Indicators)**

2 This EF stores the Base Station Latitude (BASE\_LAT\_REG), the Base Station Longitude  
 3 (BASE\_LONG\_REG) and the Registration Distance (REG\_DIST\_REG) of the base station to which  
 4 the first access probe (for a Registration Message, Origination Message or Page Response  
 5 Message) was transmitted after entering the System Access State.

6

Identifier: '6F2B'		Structure: transparent		Mandatory	
File size: 8 bytes			Update activity: high		
Access Conditions:					
READ		PIN			
UPDATE		PIN			
INVALIDATE		ADM			
REHABILITATE		ADM			
Bytes	Description			M/O	Length
1-3	BASE_LAT_REG			M	3 bytes
4-6	BASE_LONG_REG			M	3 bytes
7-8	REG_DIST_REG			M	2 bytes

7  
 8 Coding:

9 Byte 1:

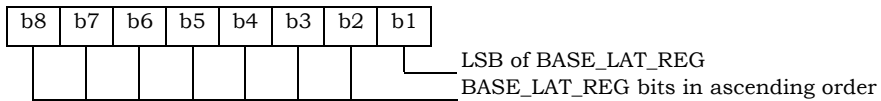

11 Byte 2:

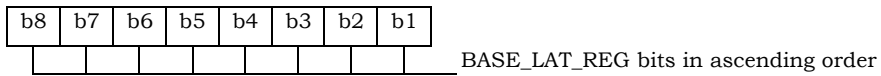

13 Byte 3:

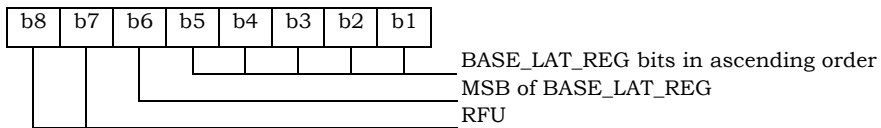

15 Byte 4:

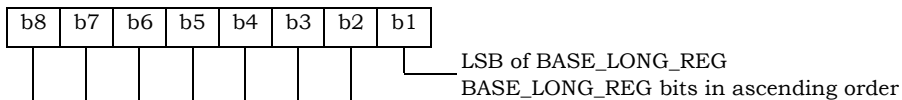

1

Byte 5:



2

3

Byte 6:

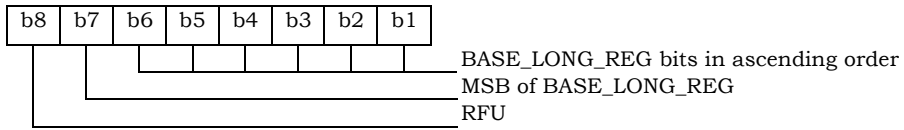

4

5

Byte 7:

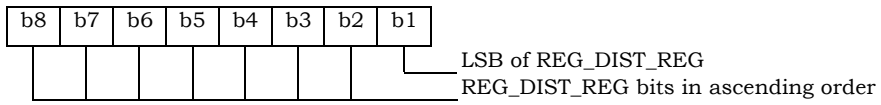

6

7

Byte 8:

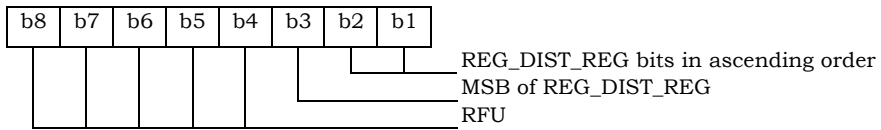

8

9

10

NOTE: The parameters for Distance-Based Registration are described in Section 2.6.5.1.4 of [5] and Section 6.6.5.1.4 of [14].

11

1 **5.2.12 EF<sub>ACCOLC</sub> (Access Overload Class ACCOLC<sub>p</sub>)**

2 This EF defines the access overload class for the mobile station. This access overload class  
 3 identifies which overload class controls access attempts by the mobile station and is used to  
 4 identify redirected overload classes in global service redirection. For normal mobile stations, the  
 5 4-bit access overload class indicator is derived from the last digit of the associated decimal  
 6 representation of the IMSI\_M via decimal to binary conversion as specified in [5] and [14].

7

Identifier: '6F2C'		Structure: transparent		Mandatory	
SFI: '03'					
File size: 1 byte			Update activity: low		
Access Conditions:					
READ		PIN			
UPDATE		ADM			
INVALIDATE		ADM			
REHABILITATE		ADM			
Bytes	Description			M/O	Length
1	Access overload class (ACCOLC <sub>p</sub> )			M	1 byte

8

9 Coding:

10

Byte 1:

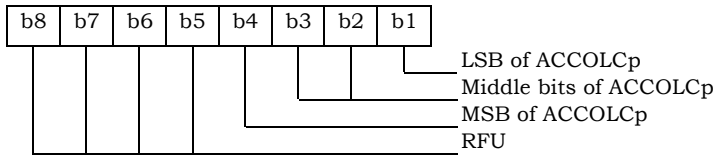

1 **5.2.13 EF<sub>TERM</sub> (Call Termination Mode Preferences)**

2 This EF contains the call termination preference MOB\_TERM\_HOME<sub>p</sub>, MOB\_TERM\_SID<sub>p</sub> and  
 3 MOB\_TERM\_FOR\_NID<sub>p</sub>.

4

Identifier: '6F2D'		Structure: transparent		Mandatory	
File size: 1 byte			Update activity: low		
Access Conditions:					
READ		PIN			
UPDATE		PIN			
INVALIDATE		ADM			
REHABILITATE		ADM			
Bytes	Description			M/O	Length
1	Call termination preferences			M	1 byte

5

6 Coding:

6

7 Byte 1:

7

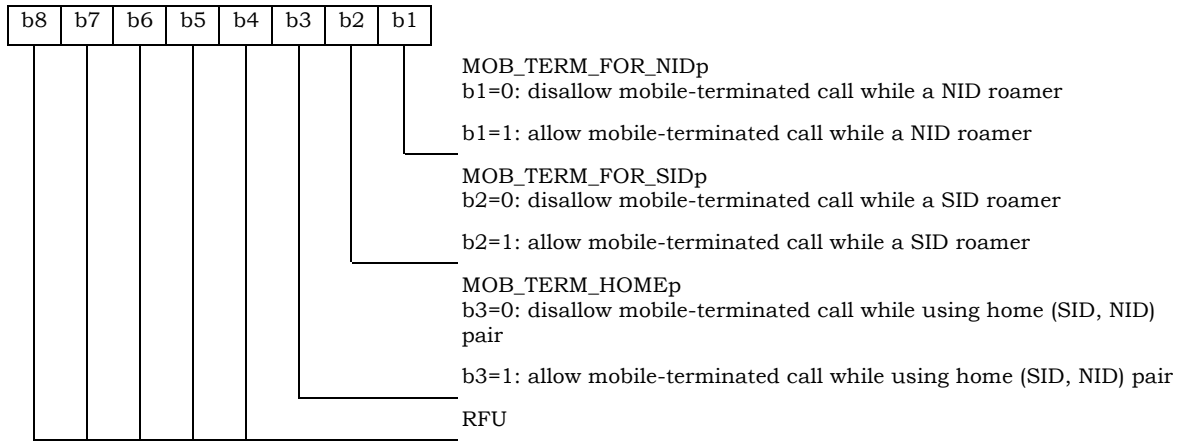

1 **5.2.14 EF<sub>SSCI</sub> (Suggested Slot Cycle Index)**

2 This EF suggests a value for the mobile station's preferred slot cycle index for CDMA operation  
 3 (see Section 2.3.11 of [5] or 6.3.11 of [14]). Since the mobile equipment may not support all the  
 4 slot cycle indexes, the mobile equipment shall select the minimum, as the preferred slot cycle  
 5 index defined in [5], between the slot cycle index supported by the mobile equipment and the  
 6 suggested slot cycle index contained in the EF<sub>SSCI</sub>.

7

Identifier: '6F2E'		Structure: transparent		Optional	
File size: 1 byte			Update activity: low		
Access Conditions:					
READ		PIN			
UPDATE		PIN			
INVALIDATE		ADM			
REHABILITATE		ADM			
Bytes	Description			M/O	Length
1	Suggested slot cycle index			M	1 byte

8

9 Coding:

10 Byte 1:

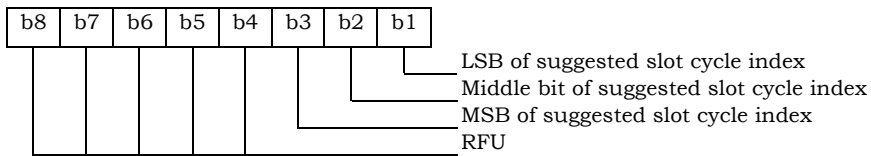

1 **5.2.15 EF<sub>ACF</sub> (Analog Channel Preferences)**

2 This EF specifies the analog mode channel preferences as determined by the service provider in  
 3 accordance with the terms of the subscription. The items addressed are the Analog Initial Paging  
 4 Channel, the Analog First Dedicated Control Channel for System A, the Analog First Dedicated  
 5 Control Channel for System B, and the Number of Dedicated Control Channels to scan.

6

Identifier: '6F2F'		Structure: transparent		Optional	
File size: 7 bytes			Update activity: low		
Access Conditions:					
READ		PIN			
UPDATE		PIN			
INVALIDATE		ADM			
REHABILITATE		ADM			
Bytes	Description	M/O	Length		
1-2	Analog Initial Paging Channel	M	2 bytes		
3-4	Analog First Dedicated Control Channel System A	M	2 bytes		
5-6	Analog First Dedicated Control Channel System B	M	2 bytes		
7	Number of Dedicated Control Channel to Scan	M	1 byte		

7  
 8 NOTE: Each channel is represented by an 11-bit binary number.

9  
 10 Coding:

11 Byte 1, 3, 5:

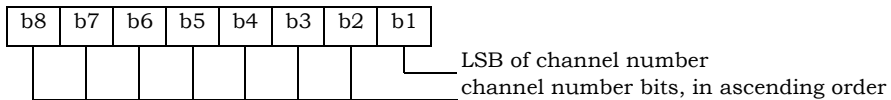

13 Byte 2, 4, 6:

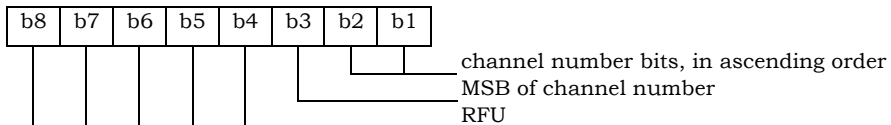

1 **5.2.16 EF<sub>PRL</sub> (Preferred Roaming List)**

2 This EF stores the Preferred Roaming List, as described in Section 3.5.5 of [7].

Identifier: '6F30'		Structure: transparent		Mandatory	
SFI: '07'					
File size: MAX_PR_LIST_SIZE for EF <sub>PRL</sub>			Update activity: low		
Access Conditions:					
READ		PIN			
UPDATE		ADM			
INVALIDATE		ADM			
REHABILITATE		ADM			
Bytes	Description		M/O	Length	
1- PR_LIST_S IZE	PR_LIST		M	PR_LIST_SIZE	

3

4 This EF is stored using the convention from [7], i.e. fields are placed into octets starting with the  
5 MSB of the first field into bit 8 of the first octet, followed by the remaining fields placed in  
6 sequence into the remaining bits allocated for those fields. A multi-octet integer is stored by  
7 placing the octet with the MSB into the lowest numbered available octet allocated for that integer  
8 in the EF.

9 - PR\_LIST

10 Contents:

11 The Preferred Roaming List.

12 Coding:

13 As defined in section 3.5.5 of [7].

1 **5.2.17 EF<sub>RUIMID</sub> (Removable UIMID)**

2 This EF stores a 32-bit electronic identification number (ID) unique to the CSIM or a 32-bit  
 3 pUIMID of the CSIM. The file may store a 32-bit pUIMID constructed in the following way — The  
 4 most significant 8 bits shall be 0x80 and the least significant 24 bits shall be the 24 least  
 5 significant bits of SHA-1 digest of the entire EUIMID, either LF\_EUIMID or SF\_EUIMID<sup>2</sup> (based on  
 6 service n34 in EF<sub>CSIM\_ST</sub>)<sup>3</sup>.

7

Identifier: '6F31'		Structure: transparent		Mandatory	
File size: 5 or 8 bytes			Update activity: low		
Access Conditions:					
READ		ALW			
UPDATE		Never			
INVALIDATE		Never			
REHABILITATE		Never			
Bytes	Description		M/O	Length	
1	Number of bytes		M	1 byte	
2	Lowest-order byte		M	1 byte	
3	:		M	1 byte	
4	:		M	1 byte	
5	:		M	1 byte	
6	:		O	1 byte	
7	:		O	1 byte	
8	Highest-order byte		O	1 byte	

8

---

<sup>2</sup> Example: if the LF\_EUIMID (ICCID) is (hexadecimal) 89 (MSB) 01 01 01 23 45 67 89 01 4F (LSB), the pseudo-UIMID is (hexadecimal) 80 (Byte 5) C5 D5 64 (Byte 2), and with Byte 1 set to 04; if the 56-bit SF\_EUIMID is (hexadecimal) FF (MSB) 00 00 01 12 34 56 (LSB), the pseudo-UIMID is (hexadecimal) 80(Byte 5) 07 37 E1(Byte 2), and with Byte 1 set to 04.

<sup>3</sup>The EUIMID (either form) is loaded into a 512-bit SHA-1 input block, starting with bit 1 of this block, to produce an output, from which the least significant 24 bits are used as the least significant 24 bits of EF(RUIMID). The 4-bit digits of EUIMID are loaded in the order d1, d2, d3, d4...dn-1, dn. Numbering the SHA-1 input buffer bits from 1 (first loaded) upwards, for each digit the most significant bit is loaded into the lowest numbered of four consecutive SHA-1 input bits and the least significant bit into the highest.

1 **5.2.18 EF<sub>CSIM\_ST</sub> (CSIM Service Table)**

2 This EF indicates which services are available. If a service is indicated as not available in the  
 3 CSIM, the ME shall not select or use that service.

4

Identifier: '6F32'		Structure: transparent		Mandatory	
SFI: '02'					
File size: X bytes, X>=1			Update activity: low		
Access Conditions:					
READ		PIN			
UPDATE		ADM			
INVALIDATE		ADM			
REHABILITATE		ADM			
Bytes	Description	M/O	Length		
1	Services n1 to n8	M	1 byte		
2	Services n9 to n16	O	1 byte		
3	Services n17 to n24	O	1 byte		
4	Services n25 to n32	O	1 byte		
:	:	:	:		
X	Services n(8X-7) to n(8X)	O	1 byte		

5

Services:	
Service n1 :	Local Phone book
Service n2 :	Fixed Dialing Numbers (FDN)
Service n3 :	Extension 2
Service n4 :	Service Dialing Numbers (SDN)
Service n5 :	Extension 3
Service n6 :	Short Message Storage
Service n7 :	Short Message Parameters
Service n8 :	HRPD
Service n9 :	Service Category Program for BC-SMS
Service n10 :	CDMA Home Service Provider Name
Service n11 :	via SMS Broadcast (for CCAT)
Service n12 :	Data Download via SMS-PP (for CCAT)
Service n13 :	Call Control for Voice Services
Service n14 :	3GPD-SIP
Service n15 :	3GPD-MIP
Service n16 :	AKA
Service n17 :	IP-based Location Services (LCS)
Service n18 :	BCMCS

Services:	
Service n19 :	Multimedia Messaging Service (MMS)
Service n20 :	Extension 8
Service n21 :	MMS User Connectivity Parameters
Service n22 :	Application Authentication
Service n23 :	Group Identifier Level 1
Service n24 :	Group Identifier Level 2
Service n25 :	De-Personalization Control Keys
Service n26 :	Cooperative Network List
Service n27 :	Outgoing Call Information (OCI)
Service n28 :	Incoming Call Information (ICI)
Service n29 :	Extension 5
Service n30 :	Multimedia Storage
Service n31 :	Image (EF <sub>IMG</sub> )
Service n32:	Reserved <sup>4</sup>
Service n33:	Reserved <sup>5</sup>
Service n34:	SF_EUIMID-based EUIMID
Service n35:	Messaging and 3GPD Extensions
Service n36:	Root Certificates
Service n37:	WAP Browser
Service n38:	Java
Service n39:	Reserved for CDG
Service n40:	Reserved for CDG
Service n41:	IPv6
Service n42:	Call Control for Data Services
Service n43:	Call Control for Mobile Originated SMS
Service n44	Card supports ENVELOPE (USSD Data Download) and ENVELOPE(Call Control) for USSD

1 The EF shall contain at least one byte. Further bytes may be included, but if the EF includes an  
2 optional byte, then it is mandatory for the EF to also contain all bytes before that byte. Other  
3 services are possible in the future and will be coded on further bytes in the EF. The coding falls  
4 under the responsibility of the 3GPP2.

5

---

<sup>4</sup> The Enabled Services Table service is deprecated. Some compliant CSIMs may have this service available.

<sup>5</sup> The Capability Configuration Parameters (CCP) service is deprecated. Some compliant CSIMs may have this service available.

Coding:

1 bit is used to code each service:

bit = 1: service available;

- The CSIM has the capability to support the service and that the service is available for the user of the CSIM unless the service is identified as "disabled" in EF<sub>EST</sub>.

bit = 0: service not available.

- The service shall not be used by the CSIM user, even if the CSIM has the capability to support the service.

First byte:

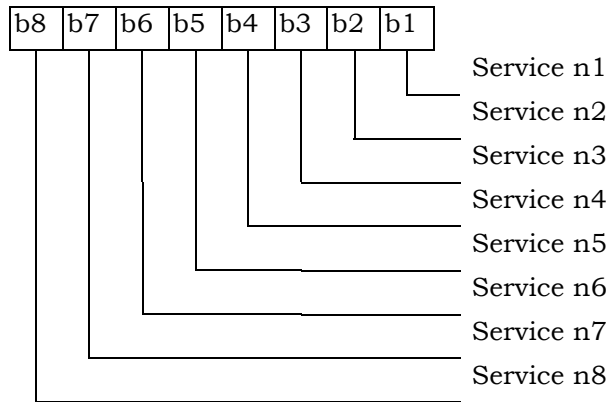

Second byte:

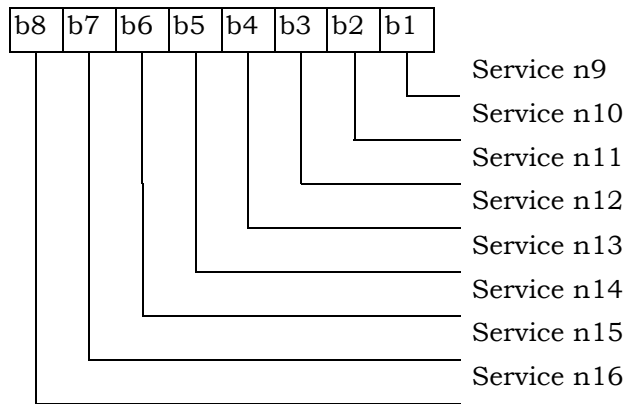

etc.

If the FDN feature is enabled according to EF<sub>EST</sub>, destination addresses which are not stored in EF<sub>FDN</sub> shall not be allowed on any voice call or SMS.

If service n34 (SF\_EUIMID-based EUIMID) is not available, ME shall fill in EXT\_UIM\_ID INFO RECORD with the entire contents of EF<sub>ICCID</sub> in response to Status Request Message defined in [5]. Otherwise, ME shall fill in EXT\_UIM\_ID INFO RECORD with SF\_EUIMID from EF<sub>SF\_EUIMID</sub>

1 **5.2.19 EF<sub>SPC</sub> (Service Programming Code)**

2 This EF includes the Service Programming Code (SPC), having a value from 0 to 999,999. The  
 3 default value is 0. Details of SPC are in [7] Section 3.3.6.

4

Identifier: '6F33'		Structure: transparent		Mandatory	
File size: 3 bytes			Update activity: low		
Access Conditions:					
READ		ADM			
UPDATE		ADM			
INVALIDATE		ADM			
REHABILITATE		ADM			
Bytes	Description			M/O	Length
1-3	Service Programming Code			M	3 bytes

5  
 6 Coding:

7 SPC is a 6-digit number  $D_1D_2D_3D_4D_5D_6$ , where  $D_1$  is the most significant digit and  $D_6$  is the  
 8 least significant digit. The coding of SPC in this EF is according to [7], Section 4.5.4.2,  
 9 whereby each digit is encoded in BCD format.

10  
 11 Byte 1:

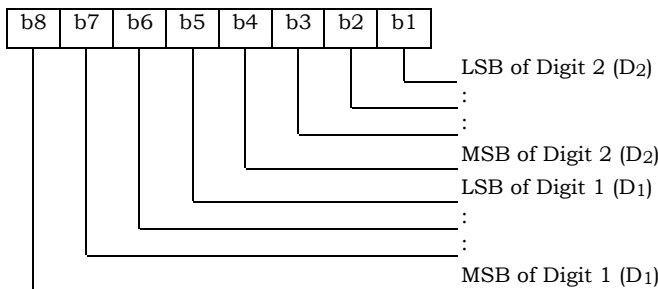

12  
 13 Byte 2:

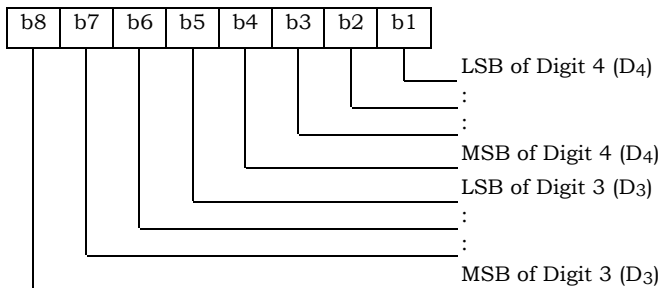

1

Byte 3:

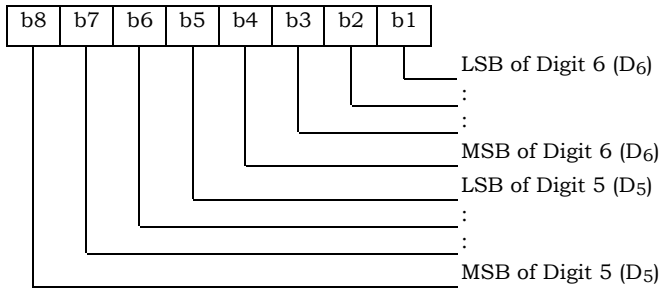

2

1 **5.2.20 EF<sub>OTAPASPC</sub> (OTAPA/SPC\_Enabled)**

2 This EF contains user-entered control information that either prevents or (else) permits network  
 3 manipulation of the SPC, and either prevents or (else) permits OTAPA to be performed on the  
 4 NAM. This EF is based upon information in [7], Sections 3.2.2 and 3.3.6. A successful base  
 5 station response to an CSIM initiated challenge is required prior to any network manipulation of  
 6 OTAPA accessible files.

7

Identifier: '6F34'		Structure: transparent		Mandatory	
File size: 1 byte			Update activity: low		
Access Conditions:					
READ		PIN			
UPDATE		PIN			
INVALIDATE		ADM			
REHABILITATE		ADM			
Bytes	Description			M/O	Length
1	OTAPA/SPC_Enable			M	1 byte

8  
 9 Coding:

10 Byte 1:

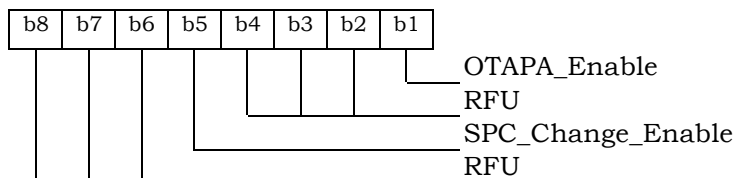

12 For "OTAPA\_Enable", a value of '0' for the NAM indicates that the user consents to the  
 13 performance of OTAPA for the NAM by the service provider. A value of '1' indicates that the user  
 14 does not permit OTAPA to be performed on the NAM. Refer to [7], Section 3.2.2.

15 For "SPC\_Change\_Enable", a value of '0' for the CSIM indicates that the user consents to allow the  
 16 service provider to change the Service Programming Code from a default value (zero) to a non-  
 17 default value (non-zero). A value of '1' indicates that the user denies permission for the service  
 18 provider to change the SPC from a default value to a non-default value. See Sec. 3.3.6 of [7].

1 **5.2.21 EF<sub>NAMLOCK</sub> (NAM\_LOCK)**

2 This EF stores the locked/unlocked state of the NAM. This EF is based upon information in [7].

3

Identifier: '6F35'		Structure: transparent		Mandatory	
File size: 1 byte			Update activity: low		
Access Conditions:					
READ		PIN			
UPDATE		PIN			
INVALIDATE		ADM			
REHABILITATE		ADM			
Bytes	Description			M/O	Length
1	SPASM protection indicator (NAM_LOCK) status			M	1 byte

4 Coding:

5 Byte 1:

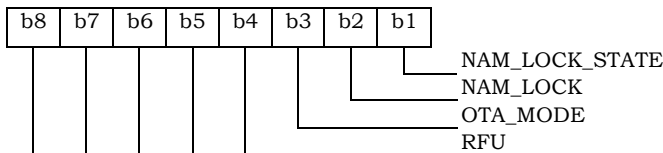

7

8 Although the UPDATE Access Condition for this EF is PIN, the ME cannot update bits 1 and 2. If

9 the ME sends an UPDATE BINARY command for this EF, the CSIM shall only use b3 through b8

10 and shall ignore bits b1 and b2.

11 Bit 1 gives the current NAM\_LOCK\_STATE. A value of '1' indicates that the NAM is locked by the

12 SPASM protection mechanism. A value of '0' indicates that the NAM is unlocked.

13 Bit 2 gives the permanent NAM\_LOCK setting (equivalent to NAM\_LOCK<sub>S-P</sub> in [7]). A value of '1'

14 indicates that the SPASM protection mechanism shall be satisfied for network initiated OTA. A

15 value of '0' indicates that SPASM protection is not required.

16 Bit 3 gives the OTA\_MODE for the current OTA session. A value of '0' indicates user-initiated,

17 and a value of '1' indicates network-initiated.

18 If an OTA programming session was initiated by the user as described in Section 3.2.1 of [7] (i.e.

19 OTA\_MODE in EF<sub>NAMLOCK</sub> is '0'), SPASM does not protect access to the NAM parameters and

20 indicators. In this case, the CSIM shall set the NAM\_LOCK\_STATE (b1) to '0' and NAM\_LOCK (b2)

21 shall not be changed.

22 On invocation of a network-initiated OTA session (after receiving an OTAPA REQUEST), the CSIM

23 shall set the value of the NAM\_LOCK\_STATE (b1) to the value of NAM\_LOCK (b2). The conditions

24 under which the values of NAM\_LOCK\_STATE and NAM\_LOCK should be changed are defined in

25 sections 3.3.1.10 (Validation Request Message) and 3.3.1.3 (Commit Request Message) of [7].

1 The ME updates the OTA\_MODE bit to tell the CSIM how an OTA session was initiated. The ME  
2 shall set this bit on initiation of an OTA session. The CSIM shall comply with the requirements in  
3 [7] (e.g. shall reject OTAPA REQUEST while in a user-initiated session).

1 **5.2.22 EF<sub>OTA</sub> (OTASP/OTAPA Features)**

2 This EF stores a listing of OTASP/OTAPA features supported by the CSIM, along with protocol  
 3 revision codes. This EF is based on the format and coding rules in Section 3.5.1.7 of [7], including  
 4 the subset of fields described below.

5

Identifier: '6F36'		Structure: transparent		Mandatory	
File size: 2*NUM_FEATURES + 1 bytes			Update activity: low		
Access Conditions:					
READ		PIN			
UPDATE		ADM			
INVALIDATE		ADM			
REHABILITATE		ADM			
Bytes		Description		M/O	Length
1		NUM_FEATURES, number of OTASP/OTAPA features		M	1 byte
2		First FEATURE_ID		M	1 byte
3		First FEATURE_P_REV		M	1 byte
		...			
2*NUM_FEATURES		Last FEATURE_ID		M	1 byte
2*NUM_FEATURES + 1		Last FEATURE_P_REV		M	1 byte

6

7 NOTE: Coding of features (FEATURE\_ID) and protocol revisions (FEATURE\_P\_REV) is described  
 8 in Table 3.5.1.7-1 (Feature Identifier) of [7].

1 **5.2.23 EF<sub>SP</sub> (Service Preferences)**

2 This EF describes the user's service preferences as defined in Section 2.3.10.1 of [5] or Sections  
 3 6.3.10.1 and 6.3.10.2 of [14].

4

Identifier: '6F37'		Structure: transparent		Mandatory	
File size: 1 byte			Update activity: low		
Access Conditions:					
READ		PIN			
UPDATE		PIN			
INVALIDATE		ADM			
REHABILITATE		ADM			
Bytes	Description			M/O	Length
1	Service Preferences (e.g. band class, analog vs. CDMA)			M	1 byte

5

6 Coding:

7

Byte 1:

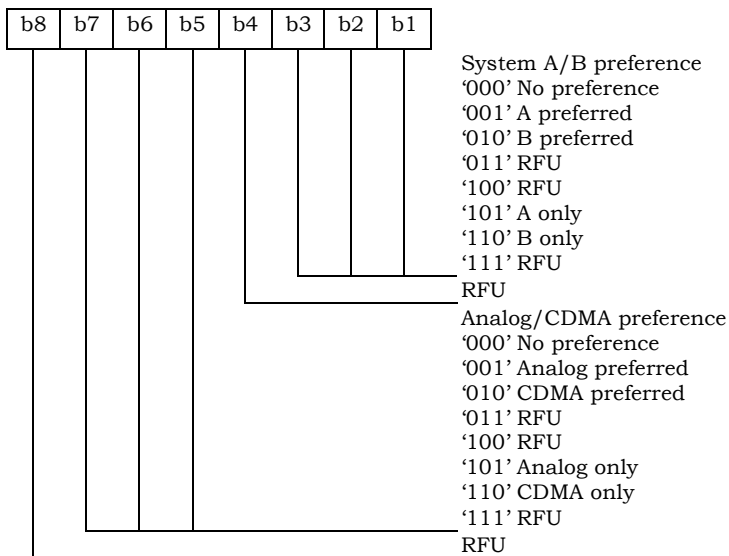

1 **5.2.24 EF<sub>ESN\_MEID\_ME</sub> (ESN\_ME or MEID\_ME)**

2 This EF stores the ESN\_ME or MEID\_ME of the Mobile Equipment (ME) to which the CSIM is  
3 attached.

4

Identifier: '6F38'		Structure: transparent		Mandatory	
File size: 8 bytes			Update activity: low		
Access Conditions:					
READ		ALW			
UPDATE		ADM			
INVALIDATE		ADM			
REHABILITATE		ADM			
Bytes	Description	M/O	Length		
1	Number of bytes for ESN_ME or MEID_ME	M	1 byte		
2	Least significant byte	M	1 byte		
3	:	M	1 byte		
4	:	M	1 byte		
5	:	M	1 byte		
6	:	M	1 byte		
7	:	M	1 byte		
8	Most significant byte	M	1 byte		

5

6 Unused bytes shall be set to '00'.

1 **5.2.25 Reserved**

1 **5.2.26 EF<sub>LI</sub> (Language Indication)**

2 This EF contains the codes for one or more languages. This information, determined by the  
 3 user/operator, defines the preferred languages of the user in order of priority. This information  
 4 may be used by the ME for UI purposes.

5

Identifier: '6F3A'		Structure: transparent		Optional	
SFI: '0A'					
File size: 2N bytes			Update activity: low		
Access Conditions:					
READ		ALW			
UPDATE		PIN			
INVALIDATE		ADM			
REHABILITATE		ADM			
Bytes	Description			M/O	Length
1 – 2	1 <sup>st</sup> language code (highest priority)			M	2 bytes
3 – 4	2 <sup>nd</sup> language code			O	2 bytes
:	:			:	:
2N-1 – 2N	N <sup>th</sup> language code (lowest priority)			O	2 bytes

6

7 Coding:

8

Byte 1:

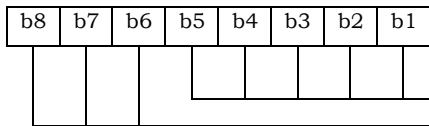

9 CHAR<sub>i</sub> Encoding type as shown in Table 9.1-1 , “Data Field  
 10 Encoding Assignments”, in [Informative 1].  
 RFU

9

10 Byte 2:

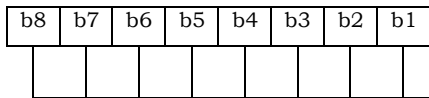

11 Language Indicator as shown in Table 9.2-1, “Language  
 Indicator Value Assignments”, in [Informative 1].

11

1 **5.2.27 EF<sub>F<sub>DN</sub></sub> (Fixed Dialing Numbers)**

2 This EF contains Fixed Dialing Numbers (FDN) and/or Supplementary Service Control strings  
 3 (SSC). In addition it contains identifiers of associated network/bearer capabilities and identifiers  
 4 of extension records at the CSIM ADF level. It may also contain an associated alpha-tagging. If  
 5 this file is present in the CSIM, the Enabled Services Table (EF<sub>EST</sub>) shall also be present.  
 6

Identifier: '6F3B'		Structure: linear fixed		Optional	
Record length: X+14 bytes			Update activity: low		
Access Conditions:					
READ		PIN			
UPDATE		PIN2			
DEACTIVATE		ADM			
ACTIVATE		ADM			
Bytes	Description	M/ O	Length		
1 to X	Alpha Identifier	O	X bytes		
X+1	Length of BCD number/SSC contents	M	1 byte		
X+2	TON and NPI	M	1 byte		
X+3 to X+12	Dialing Number/SSC String	M	10 bytes		
X+13	Reserved ('FF')	M	1 byte		
X+14	Extension2 (EF <sub>EXT2</sub> ) Record Identifier	M	1 byte		

7

8 For contents and coding of all data items, see the respective data items of the EF<sub>ADN</sub> (Section  
 9 5.4.1), with the exception that extension records are stored in the EF<sub>EXT2</sub>.

10 NOTE: The value of X (the number of bytes in the alpha-identifier) may be different to the length  
 11 denoted X in EF<sub>ADN</sub>.

1 **5.2.28 EF<sub>SMS</sub> (Short Messages)**

2 This EF contains information in accordance with [8] comprising short messages (and associated  
3 parameters) which have either been received by the MS from the network or are to be used as an  
4 MS originated message.

5

Identifier: '6F3C'		Structure: linear fixed		Optional	
Record Length: variable (1)			Update activity: high		
Access Conditions:					
READ		PIN			
UPDATE		PIN			
INVALIDATE		ADM			
REHABILITATE		ADM			
Bytes	Description	M/O	Length		
1	Status	M	1 byte		
2	MSG_LEN	M	1 byte		
3 – 3+MSG_L EN	SMS Transport Layer Message	M	MSG_LEN bytes		

6

7 Note: (1) The length and the byte allocations are variable according to the actual size of the  
8 SMS Transport Layer message. The maximum length is 255, which includes the  
9 length of the short message plus two bytes for storing “status” and “MSG\_LEN”.

10 - Status

11 Contents:

12 Status byte of the record which can be used as a pattern in the SEEK command. For MS  
13 originating messages sent to the network, the status shall be updated when the MS  
14 receives a status report or sends a successful SMS Command relating to the status report.

1  
2  
3  
4  
5  
6  
7  
8  
9  
10  
11  
12  
13  
14

Coding:

Byte 1:

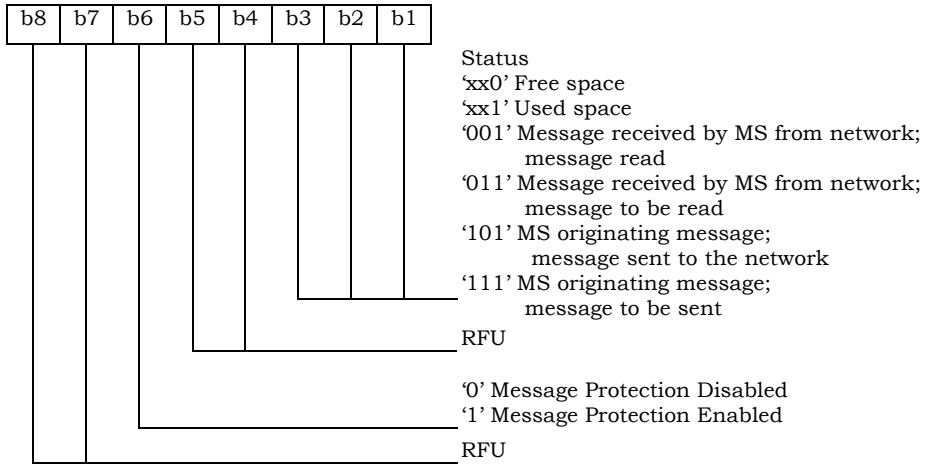

- MSG\_LEN

Contents:

The length of the message, not including MSG\_LEN. Note that the definition of this EF does allow multiple occurrences of the segment, which consists of "PARAMETER\_ID", "PARAMETER\_LEN", and "Parameter Data" as described in [8]. The number of repetitions of the aforementioned segment is determined by MSG\_LEN and the PARAMETER\_LEN of each segment.

- SMS Transport Layer Message

Contents: see Section 3.4.1 of [8].

### 5.2.29 EF<sub>SMS</sub> (Short Message Service Parameters)

This EF contains values for Short Message Service Parameters (SMS), which can be used by the Mobile Equipment (ME) for user assistance in preparation of mobile originated short messages.

The EF consists of one or more records, with each record able to hold a set of SMS parameters. The first (or only) record in the EF shall be used as a default set of parameters, if no other record is selected. To distinguish between records, a four-byte Teleservice Identifier as defined in [8] shall be included within each record. The SMS parameters stored within a record may be present or absent independently. When an SMS is to be sent, the parameters in the CSIM record that has the same Teleservice Identifier as the one in the mobile-originated message, if present, can be used by the ME when a value is not supplied by the user.

Identifier: '6F3D'		Structure: linear fixed		Optional
Record Length: variable (10+X)		Update activity: high		
Access Conditions:				
READ		PIN		
UPDATE		PIN		
INVALIDATE		ADM		
REHABILITATE		ADM		
Bytes	Description	M/O	Length	
1-4	Teleservice Identifier	M	4 bytes	
5-6	Parameter Indicators	M	2 bytes	
7	Reserved	M	1 byte	
8-(8+N-1)	Destination Address	M	N (Note 1)	
8+N	MSG_ENCODING	M	1 byte	
9+N	Validity Period	M	1 byte	
(Note 2)	Service Category	O	4 bytes	
(Note 2)	Destination Subaddress	O	Variable (Note 2)	
(Note 2)	Bearer Reply Option	O	3 bytes	
(Note 2)	Bearer Data	O	Variable (Note 2)	
(Note 2) (Note 3)	Padding	O	Variable (Note 2) (Note 3)	

Notes: (1) N is 1 if the Parameter Indicators field indicates that the Destination Address is absent. Otherwise, N is the length of a valid destination address..

(2) Starting and ending bytes and length depend on the presence and absence of parameters indicated by the Parameter Indicators field.

1 (3) Padding is mandatory if the fields before it do not occupy all the 10+X  
 2 bytes. Padding, if present, always ends at byte number 10+X..  
 3

4 Any bytes unused, due to parameters not requiring all of the bytes, or due to absent parameters,  
 5 shall be set to 'FF'.

6 - Teleservice Identifier

7 Contents:

8 The supported teleservices include *IS-91 Extended Protocol Enhanced Services*, *Wireless*  
 9 *Paging Teleservice*, *Wireless Messaging Teleservice*, *Voice Mail Notification* and *Wireless*  
 10 *Application Protocol*. See section 3.4.3.1 of [8] for details.

11 Coding:

12 4-byte Teleservice Identifier as defined in 3.4.3.1 of [8].  
 13

14 - Parameter Indicators

15 Contents:

16 Each of the default SMS parameters which can be stored in the remainder of the record  
 17 are marked absent or present by individual bits within this byte.

18 Coding:

19 Byte 5:

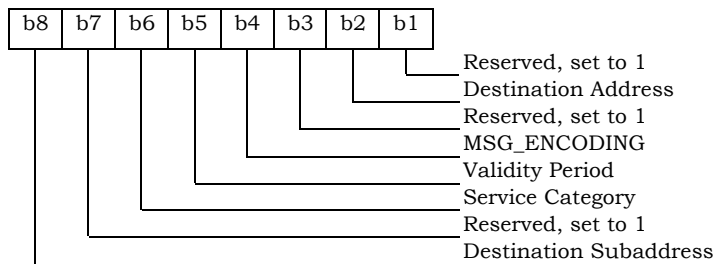

20  
 21 Byte 6:

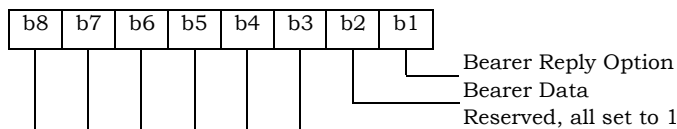

22  
 23 Note: Bit value 0 means parameter present  
 24 Bit value 1 means parameter absent

25 - Reserved

26 Set to 'FF'.

1 - Destination Address

2 If the Parameter Indicators field indicates this parameter is present, the contents and  
 3 coding are defined in section 3.4.3.3 Address Parameters of [8]. It contains  
 4 PARAMETER\_ID, PARAMETER\_LEN and parameter data.

5 If the Parameter Indicators field indicates this parameter is absent, then it shall be set  
 6 to 'FF' with a length of 1 byte.

7  
 8 - MSG\_ENCODING

9 Contents:

10 If the Parameter Indicators field indicates this parameter is present, the contents and  
 11 coding are defined in Table 9.1-1 Data Field Encoding Assignments of [Informative 1].  
 12 This parameter can appear in the Bearer Data if Bearer Data is present. If this  
 13 parameter appears in the Bearer Data too, then the same value shall be used by this  
 14 parameter. If this parameter appears in the Bearer Data, then this parameter shall be  
 15 present.

16  
 17 Coding:

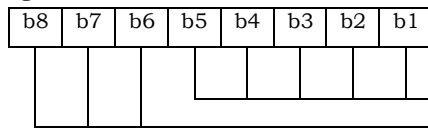

CHARi encoding type as specified in Table 9.1 1, Data Field  
 Encoding Assignments, in [Informative 1].  
 RFU

18 If the Parameter Indicators field indicates this field is absent, it shall be set to 'FF'.  
 19

20 - Validity Period

21 Contents and Coding:

22 If the Parameter Indicators field indicates this parameter is present, the contents and  
 23 coding are defined in section 4.5.6 of [8] for the VALIDITY field of the relative time  
 24 format. This parameter can appear in the Bearer Data if Bearer Data is present. If this  
 25 parameter appears in the Bearer Data too, then the same value shall be used by this  
 26 parameter. If this parameter appears in the Bearer Data, then this parameter shall be  
 27 present.

28 If the Parameter Indicators field indicates this field is absent, it shall be set to 'FF'.  
 29

30 - Service Category

31 Contents and Coding:

32 As defined in section 3.4.3.2 Service Category of [8]. It contains PARAMETER\_ID,  
 33 PARAMETER\_LEN and parameter data. Destination Subaddress  
 34

1           - Destination Subaddress

2                 Contents and Coding:

3                     As defined in section 3.4.3.4 Subaddress of [8]. It contains PARAMETER\_ID,  
4                     PARAMETER\_LEN and parameter data.

5

6           - Bearer Reply Option

7                 Contents and Coding:

8                     As defined in section 3.4.3.5 Bearer Reply Option of [8]. It contains PARAMETER\_ID,  
9                     PARAMETER\_LEN and parameter data.

10          - Bearer Data

11                 Contents and Coding:

12                     As defined in section 3.4.3.7 Bearer Data of [8]. It contains PARAMETER\_ID,  
13                     PARAMETER\_LEN and parameter data.

14

15          - Padding

16                 Contents and Coding:

17                     All bytes for this field shall be set to 'FF' .

### 5.2.30 EF<sub>SMSS</sub> (SMS Status)

This EF contains status information relating to the short message service.

The provision of this EF is associated with EF<sub>SMS</sub>. Both files shall be present together or both shall be absent from the CSIM.

Identifier: '6F3E'		Structure: transparent		Optional	
File size: 5 + X bytes			Update activity: low		
Access Conditions:					
READ		PIN			
UPDATE		PIN			
INVALIDATE		ADM			
REHABILITATE		ADM			
Bytes	Description	M/O	Length		
1 – 2	MESSAGE_ID	M	2 bytes		
3 – 4	WAP MESSAGE_ID	M	2 bytes		
5	SMS "Memory Cap. Exceeded" Notification Flag/SMS Timestamp Mode	M	1 byte		
6-5 + X	Reserved	O	X bytes		

#### - MESSAGE\_ID

Contents:

The value of the MESSAGE\_ID in the last sent *SMS Submit Message* from a teleservice which requires message identifiers other than the WAP teleservice.

Coding: as defined in [8].

#### - WAP MESSAGE\_ID

Contents:

The value of the MESSAGE\_ID in the last sent *SMS Submit Message* from the WAP teleservice.

Coding: as defined in [8].

#### - SMS "Memory Capacity Exceeded" Notification Flag/SMS Timestamp Mode.

Contents:

Includes a flag that indicates whether or not there is memory capacity available to store SMS messages. Also includes a bit that indicates whether the SMS Timestamp mode is UTC or non-UTC.

1

Coding:

2

Byte 5:

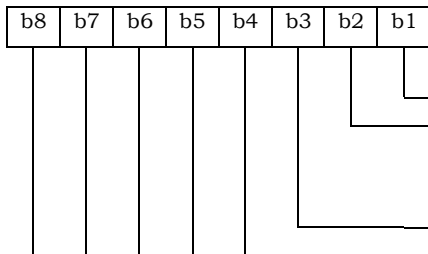

b1=0: flag set  
b1=1: flag unset; memory capacity available  
Reserved, set to 1  
b3=0: SMS Timestamp mode is UTC.  
b3=1: SMS Timestamp mode is non-UTC.  
Note: The SMS Timestamp mode is configured by the service provider.  
Reserved, all bits set to 1

3

### 5.2.31 EF<sub>SSFC</sub> (Supplementary Services Feature Code Table)

This EF stores the numeric feature code to be used by the ME when a supplementary service is invoked in CDMA or analog mode via an implementation-dependent user interface (such as a menu) that automatically inserts a feature code into the dialed digit string. Because feature codes are service-provider specific, this EF is required to enable the ME to perform the mapping to the feature code.

When a supplementary service is invoked in CDMA or analog mode, the mobile station shall determine the feature code by reading the Supplementary Service Feature Code Table entry for the selected supplementary service, and pre-pending with an asterisk.

Identifier: '6F3F'		Structure: transparent		Optional	
File size: 2N+1			Update activity: low		
Access Conditions:					
READ		PIN			
UPDATE		PIN			
INVALIDATE		ADM			
REHABILITATE		ADM			
Bytes	Description	M/O	Length		
1	N, Number of Feature Codes	M	1 byte		
2 – 3	Activate Call Delivery (CD)	M	2 bytes		
4 – 5	De-activate Call Delivery (CD)	M	2 bytes		
6 – 7	Register new Call Forwarding – Busy (CFB) forward-to number	M	2 bytes		
8 – 9	Register Call Forwarding – Busy (CFB) to voice mail	M	2 bytes		
10 – 11	De-register Call Forwarding – Busy (CFB)	M	2 bytes		
12 – 13	Activate Call Forwarding – Busy (CFB)	M	2 bytes		
14 – 15	De-activate Call Forwarding – Busy (CFB)	M	2 bytes		
16 – 17	Register new Call Forwarding – Default (CFD) forward-to number	M	2 bytes		
18 – 19	Register Call Forwarding – Default (CFD) to voice mail	M	2 bytes		
20 – 21	De-register Call Forwarding – Default (CFD)	M	2 bytes		
22 – 23	Activate Call Forwarding – Default (CFD)	M	2 bytes		
24 – 25	De- activate Call Forwarding – Default (CFD)	M	2 bytes		
26 – 27	Register new Call Forwarding – No Answer (CFNA) forward-to number	M	2 bytes		
28 – 29	Register Call Forwarding – No Answer (CFNA) to voice mail	M	2 bytes		
30 – 31	De-register Call Forwarding – No Answer (CFNA)	M	2 bytes		
32 – 33	Activate Call Forwarding – No Answer (CFNA)	M	2 bytes		
34 – 35	De-activate Call Forwarding – No Answer (CFNA)	M	2 bytes		

Bytes	Description	M/ O	Length
36 – 37	Register new Call Forwarding – Unconditional (CFU) forward-to number	M	2 bytes
38 – 39	Register Call Forwarding – Unconditional (CFU) to voice mail	M	2 bytes
40 – 41	De-register Call Forwarding – Unconditional (CFU)	M	2 bytes
42 – 43	Activate Call Forwarding – Unconditional (CFU)	M	2 bytes
44 – 45	De-activate Call Forwarding – Unconditional (CFU)	M	2 bytes
46 – 47	Activate Call Waiting (CW)	M	2 bytes
48 – 49	De-activate Call Waiting (CW)	M	2 bytes
50 – 51	Temporarily De-activate Call Waiting (Cancel Call Waiting - CCW)	M	2 bytes
52 – 53	Temporarily Activate Calling Number Identification Restriction (CNIR) (per-call blocking)	M	2 bytes
54 – 55	Temporarily De-activate Calling Number Identification Restriction (CNIR) (per-call allowed)	M	2 bytes
56 – 57	Invoke Conference Calling (CC)	M	2 bytes
58 – 59	Invoke Drop Last Conference Calling (CC) Party	M	2 bytes
60 – 61	Activate Do Not Disturb (DND)	M	2 bytes
62 – 63	De-activate Do Not Disturb (DND)	M	2 bytes
64 – 65	Activate Message Waiting Notification (MWN) Alert Pip Tone	M	2 bytes
66 – 67	De-activate Message Waiting Notification (MWN) Alert Pip Tone	M	2 bytes
68 – 69	Activate Message Waiting Notification (MWN) Pip Tone	M	2 bytes
70 – 71	De-activate Message Waiting Notification (MWN) Pip Tone	M	2 bytes
72 – 73	Temporarily De-activate Message Waiting Notification (MWN) Pip Tone (Cancel MWN - CMWN)	M	2 bytes
74 – 75	Invoke Priority Access and Channel Assignment (PACA)	M	2 bytes
76 – 77	Invoke Voice Message Retrieval (VMR)	M	2 bytes
78 – 79	Activate Calling Name Presentation (CNAP)	M	2 bytes
80 – 81	De-activate Calling Name Presentation (CNAP)	M	2 bytes
82 – 83	Activate Calling Name Restriction (CNAR)	M	2 bytes
84 – 85	De-activate Calling Name Restriction (CNAR)	M	2 bytes
86 – 87	Activate Automatic Callback (AC)	M	2 bytes
88 – 89	De-activate Automatic Callback (AC)	M	2 bytes
90 – 91	Activate Automatic Recall (AR)	M	2 bytes
92 – 93	De-activate Automatic Recall (AR)	M	2 bytes
94 – 95	Register new network registered User Selectable Call Forwarding (USCF) directory number	M	2 bytes
96 – 97	Activate Rejection of Undesired Annoying Calls (RUAC)	M	2 bytes
98 – 99	De-activate Rejection of Undesired Annoying Calls (RUAC)	M	2 bytes
100 –	Invoke Advice of Charge (AOC)	M	2 bytes

Bytes	Description	M/O	Length
101			
102 – 103	Invoke Call Trace (COT)	M	2 bytes
...	...	...	...
2N – 2N+1	FCN	M	2 bytes

1  
2 N, Number of Feature Codes, indicates the number of feature codes.

3 A feature code of up to four digits shall be encoded via BCD into the two bytes of the feature code  
4 table entry as follows:

- 5 - represent these four digits as  $D_1D_2D_3D_4$ .
- 6 - if the feature code (FC) is less than four digits, the unused digits shall be set to 'F'.

7  
8 Coding:

9 First byte:

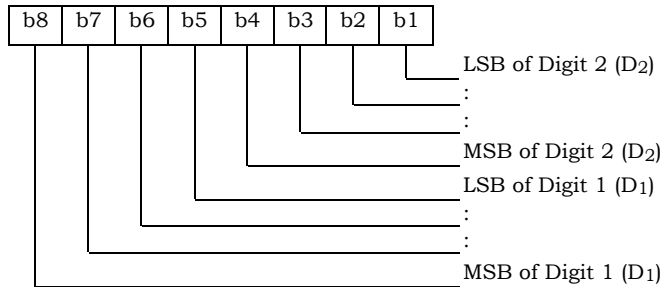

10  
11 Second byte:

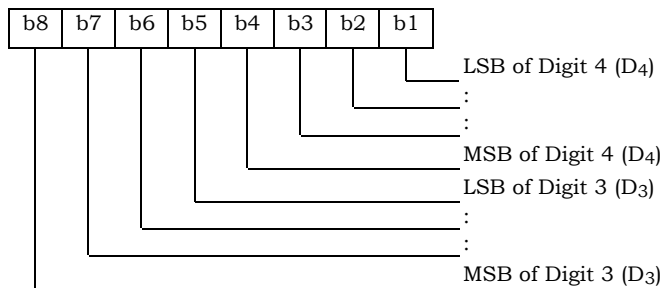

1 **5.2.32 EF<sub>SPN</sub> (CDMA Home Service Provider Name)**

2 If service n10 is available, this EF shall be present. This EF contains the home service provider  
 3 name and appropriate requirements for display by the ME.  
 4

Identifier: '6F41'		Structure: transparent		Optional	
SFI: '08'					
File size: 35 bytes			Update activity: low		
Access Conditions:					
READ		ALW			
UPDATE		ADM			
INVALIDATE		ADM			
REHABILITATE		ADM			
Bytes	Description	M/O	Length		
1	Display Condition	M	1 byte		
2	Character Encoding	M	1 byte		
3	Language Indicator	M	1 byte		
4 – 35	Service Provider Name	M	32 bytes		

- 5  
 6 - Display Condition

7 Contents:

8 An indication of whether or not the home service provider name shall be displayed by a  
 9 MS which supports this feature.

10 Coding:

11 Byte 1:

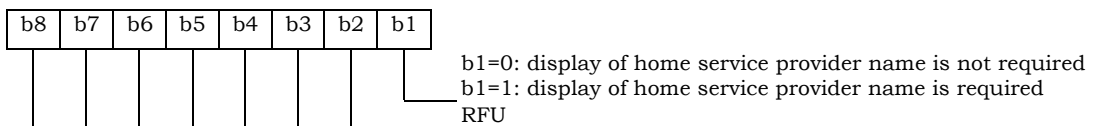

13 Byte 2:

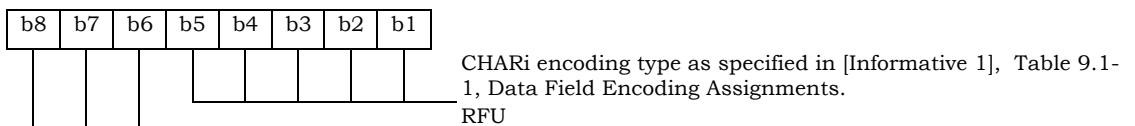

15 Byte 3:

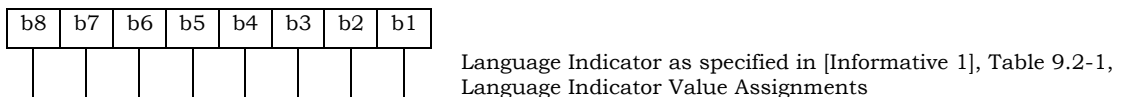

- 1 Bytes 4 – 35:
- 2 - Service Provider Name
- 3 Contents: Service provider string to be displayed.

4 Coding:

5 The string shall use SMS conventions as defined in Tables 9.1-1 and 9.2-1 of  
6 [Informative 1]. The string shall be stored in sequence with the first character in byte  
7 4. Unused bytes shall be stored in the highest numbered bytes and shall be set to  
8 'FF'.

9 If the string is coded as 7-bit, the SMS default 7-bit coded alphabet as referenced in  
10 [Informative 1] with bit 8 set to 0 shall be used.

1 **5.2.33 EF<sub>USGIND</sub> (UIMID/SF\_EUIMID Usage Indicator)**

2 This EF indicates whether the UIMID or ESN\_ME is used as the ESN value for CAVE  
 3 authentication and MS identification, as per Section 4.6.1 of [46]. This EF also indicates whether  
 4 the SF\_EUIMID or MEID\_ME shall be used as the MEID field over the air when Service n34 is  
 5 available.  
 6

Identifier: '6F42'		Structure: transparent		Mandatory	
File size: 1 byte			Update activity: low		
Access Conditions:					
READ		PIN			
UPDATE		ADM			
INVALIDATE		ADM			
REHABILITATE		ADM			
Bytes	Description			M/O	Length
1	UIMID/SF_EUIMID Usage Indicator			M	1 byte

7  
 8 Coding:

9 Byte 1:

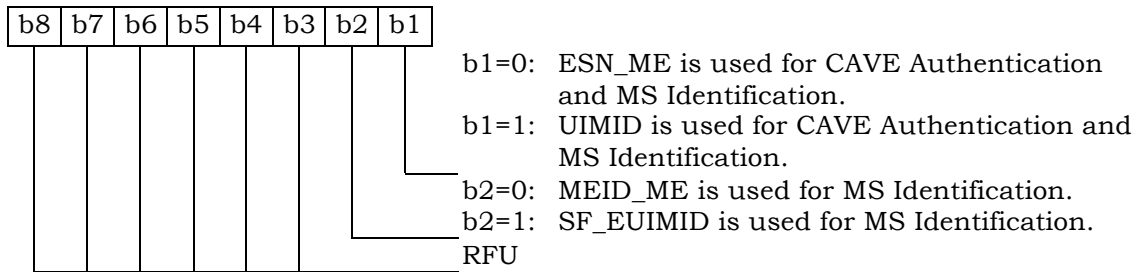

10  
 11 The ME shall interpret b2 only if the ME is assigned with an MEID\_ME and service n34 is  
 12 available.

1 **5.2.34 EF<sub>AD</sub> (Administrative Data)**

2 This EF contains information concerning the mode of operation according to the type of UIM. It  
 3 also provides an indication whether some ME features should be activated during the normal  
 4 operation.

5

Identifier: '6F43'		Structure: transparent		Mandatory	
SFI: '01'					
File size: 3+X bytes			Update activity: low		
Access Conditions:					
READ		ALW			
UPDATE		ADM			
INVALIDATE		ADM			
REHABILITATE		ADM			
Bytes	Description			M/O	Length
1	MS operation mode			M	1 byte
2 – 3	Additional information			M	2 bytes
4 – 3+X	RFU			O	X bytes

6

7

8

- MS operation mode

9

Contents:

10

mode of operation for the MS.

11

12

Coding:

13

Initial value

14

- normal operation '00'.

15

16

Refer to [17] for other operational values.

17

18

Byte 1:

19

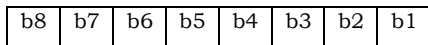

b8 through b1='00000000'.

20

21

22

- Additional information

23

Coding:

24

- specific facilities (if b1=1 in byte 1);

25

1  
2  
3  
4

Byte 2: (first byte of additional information)

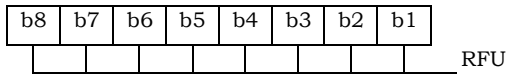

Byte 3:

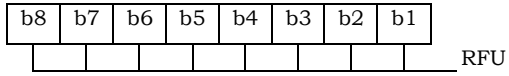

1 **5.2.35 EF<sub>MDN</sub> (Mobile Directory Number)**

2 This EF stores the Mobile Directory Number, Type of Number, Numbering Plan, Presentation  
 3 Indicator and Screening Indicator.

4

Identifier: '6F44'		Structure: linear fixed		Optional	
Record length: 11 bytes			Update activity: low		
Access Conditions:					
READ		PIN			
UPDATE		PIN			
INVALIDATE		ADM			
REHABILITATE		ADM			
Bytes	Description			M/O	Length
1	Number of digits			M	1 byte
2 – 9	MDN			M	8 bytes
10	NUMBER_TYPE and NUMBER_PLAN			M	1 byte
11	PI and SI			M	1 byte

5

6 Coding:

6

7 Byte 1:

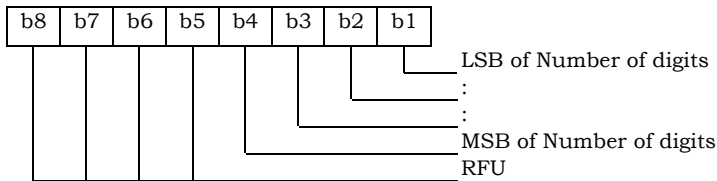

8

9 Byte 2 through 9 store MDN up to 15 digits described in Section 2.3.1.4 of [5] and Section 6.3.1.4  
 10 of [14]. Each digit shall be encoded according to Table 2.7.1.3.2.4-4 of [5] and Table 6.7.1.3.2.4-4  
 11 of [14]. If MDN requires less than 15 digits, excess nibbles at the end of data shall be set to 'F'.

12

13 Byte 2:

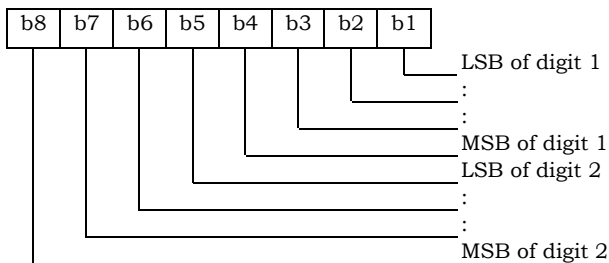

14

15 And Bytes 3 through 8 shall follow the same format as Byte 2.

1

Byte 9:

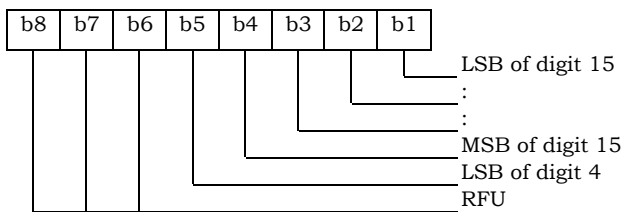

2

3

Byte 10:

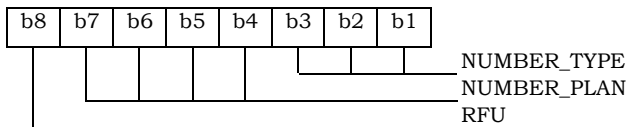

4

Refer to Section 2.7.4.4 of [5] or Section 6.7.4.4 of [14].

5

6

Byte 11:

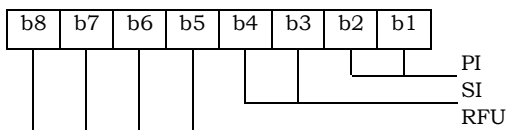

7

Refer to Section 2.7.4.4 of [5] or Section 6.7.4.4 of [14].

1 **5.2.36 EF<sub>MAXPRL</sub> (Maximum PRL)**

2 This EF stores the maximum size, in octets, that the CSIM can support for EF Preferred Roaming  
3 List and EF Extended Preferred Roaming List. See 3.5.3.1 and 3.5.3.3 of [7] for more detail.

Identifier: '6F45'		Structure: transparent		Mandatory	
File size: 2 or 4 bytes			Update activity: Never		
Access Conditions:					
READ		PIN			
UPDATE		ADM			
INVALIDATE		ADM			
REHABILITATE		ADM			
Bytes	Description			M/O	Length
1 – 2	MAX_PR_LIST_SIZE for EF <sub>PRL</sub>			M	2 bytes
3 – 4	MAX_PR_LIST_SIZE for EF <sub>EPRL</sub>			O	2 bytes

4

5 This EF is stored using the convention from [7], i.e. fields are placed into octets starting with the  
6 MSB of the first field into bit 8 of the first octet, followed by the remaining fields placed in  
7 sequence into the remaining bits allocated for those fields. A multi-octet integer is stored by  
8 placing the octet with the MSB into the lowest numbered available octet allocated for that integer  
9 in the EF.

10 The 'MAX\_PR\_LIST\_SIZE for EF<sub>EPRL</sub>' field shall be included if EF<sub>EPRL</sub> is present.

1 **5.2.37 EF<sub>SPCS</sub> (SPC Status)**

2 This EF identifies whether the EF<sub>SPC</sub> (Service programming code) is set to default and internally  
 3 updated in the card to reflect the current state of SPC after an OTASP commit if the SPC was  
 4 changed. Details of SPC are in [7], Section 3.3.6.

5

Identifier: '6F46'		Structure: transparent		Mandatory	
File size: 1 byte			Update activity: low		
Access Conditions:					
READ		PIN			
UPDATE		Never			
INVALIDATE		Never			
REHABILITATE		Never			
Bytes	Description			M/O	Length
1	SPC Status			M	1 byte

6

7 - SPC Status

8

9 Coding:

10

11

Byte 1:

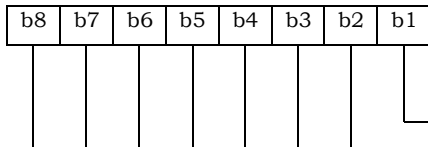

SPC Status  
 b1=0: SPC is set to default value  
 b1=1: SPC is set to any value other than the default value  
 RFU

12

1 **5.2.38 EF<sub>ECC</sub> (Emergency Call Codes)**

2 This EF contains emergency call codes (ECCs).

3

Identifier: '6F47'		Structure: transparent		Optional	
SFI: '09'					
File size: 3n bytes			Update activity: low		
Access Conditions:					
READ		ALW			
UPDATE		ADM			
INVALIDATE		ADM			
REHABILITATE		ADM			
Bytes	Description	M/O	Length		
1 - 3	Emergency Call Code 1	O	3 bytes		
4 - 6	Emergency Call Code 2	O	3 bytes		
(3n-2) to 3n	Emergency Call Code n	O	3 bytes		

4

5 - Emergency Call Code

6 Contents:

7 Emergency Call Code. Each digit is encoded in BCD format.

8

9 Coding:

10 The emergency call code is of a variable length with a maximum length of 6 digits.

11 Each emergency call code is coded on three bytes, with each digit within the code  
 12 being coded on four bits as shown below. If a code of less than 6 digits is chosen, then  
 13 the unused nibbles shall be set to 'F'.

14

15 Byte 1:

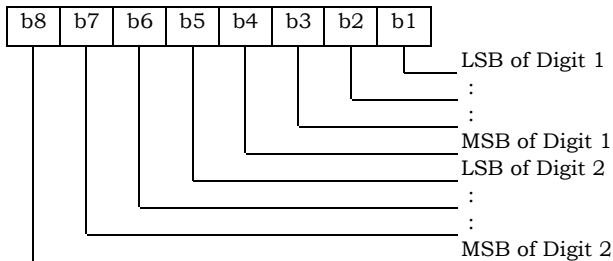

16

1

Byte 2:

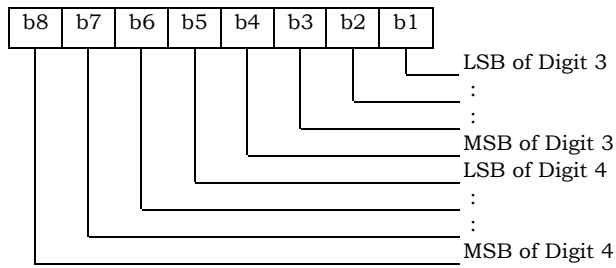

2

3

Byte 3:

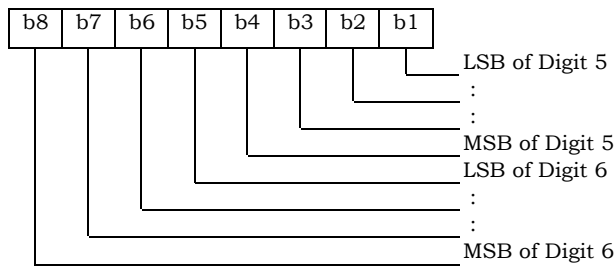

4

1 **5.2.39 EF<sub>ME3GPDOPC</sub> (ME 3GPD Operation Capability)**

2 If either service n14 or n15 is available (see Section 5.2.18), this EF shall be present. This EF  
 3 stores IP operation capabilities supported by the ME.  
 4

Identifier: '6F48'		Structure: transparent		Optional	
File size: 1 byte			Update activity: low		
Access Conditions:					
READ		PIN			
UPDATE		PIN			
INVALIDATE		ADM			
REHABILITATE		ADM			
Bytes	Description			M/O	Length
1	see [7], 3GPD Operation Capability Parameters			M	1 byte

5  
 6 3GPD Operation Capability Parameters

7 Coding (see Section 3.5.8.1 of [7]):

8 Byte 1:

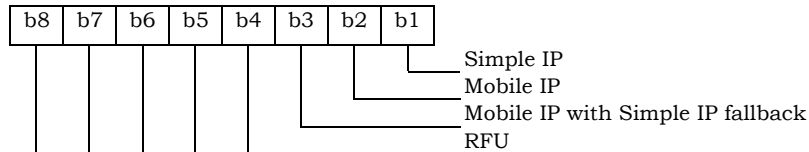

9  
 10 After the selection of ADF<sub>CSIM</sub> during the initialization, the CSIM shall set the value of this byte to  
 11 "0". An ME that supports Simple IP or Mobile IP shall set each subfield to '1' if it supports the  
 12 corresponding operating mode.

13

1 **5.2.40 EF<sub>3GPDOPM</sub> (3GPD Operation Mode)**

2 If either service n14 or n15 is available (see Section 5.2.18), this EF shall be present. This EF  
 3 stores the 3GPD Operation Mode Parameter Block defined in [7].

4

Identifier: '6F49'		Structure: transparent		Optional	
File size: 1 byte			Update activity: low		
Access Conditions:					
READ		PIN			
UPDATE		PIN			
INVALIDATE		ADM			
REHABILITATE		ADM			
Bytes	Description			M/O	Length
1	See [7], 3GPD Operation Mode Parameter Block			M	1 byte

5

6 Coding:

6

7 Byte 1:

7



1 **5.2.41 EF<sub>SIPCAP</sub> (Simple IP Capability Parameters)**

2 If service n14 is available (see Section 5.2.18), this EF shall be present. This EF stores the  
3 SimpleIP Capability Parameter Block defined in [7].

4

Identifier: '6F4A'		Structure: transparent		Optional	
File size: 4 bytes			Update activity: low		
Access Conditions:					
READ		PIN			
UPDATE		ADM			
INVALIDATE		ADM			
REHABILITATE		ADM			
Bytes	Description			M/O	Length
1 – 4	See [7], SimpleIP Capability Parameter Block			M	4 bytes

5

6 This EF is stored using the convention from [7], i.e. fields are placed into octets starting with the  
7 MSB of the first field into bit 8 of the first octet, followed by the remaining fields placed in  
8 sequence into the remaining bits allocated for those fields. A multi-octet integer is stored by  
9 placing the octet with the MSB into the lowest numbered available octet allocated for that integer  
10 in the EF.

1 **5.2.42 EF<sub>MIPCAP</sub> (Mobile IP Capability Parameters)**

2 If service n15 is available (see Section 5.2.18), this EF shall be present. This EF stores the  
 3 MobileIP Capability Parameter Block defined in [7].

4

Identifier: '6F4B'		Structure: transparent		Optional	
File size: 5 bytes			Update activity: low		
Access Conditions:					
READ		PIN			
UPDATE		ADM			
INVALIDATE		ADM			
REHABILITATE		ADM			
Bytes	Description			M/O	Length
1-5	See [7], MobileIP Capability Parameter Block			M	5 bytes

5

6 This EF is stored using the convention from [7], i.e. fields are placed into octets starting with the  
 7 MSB of the first field into bit 8 of the first octet, followed by the remaining fields placed in  
 8 sequence into the remaining bits allocated for those fields. A multi-octet integer is stored by  
 9 placing the octet with the MSB into the lowest numbered available octet allocated for that integer  
 10 in the EF.

1 **5.2.43 EF<sub>SIPUPP</sub> (Simple IP User Profile Parameters)**

2 If service n14 is available (see Section 5.2.18), this EF shall be present. This EF stores the  
3 SimpleIP User Profile Parameter Block defined in [7].

4

Identifier: '6F4C'		Structure: transparent		Optional	
File size: 1+X			Update activity: low		
Access Conditions:					
READ		PIN			
UPDATE		ADM			
INVALIDATE		ADM			
REHABILITATE		ADM			
Bytes	Description			M/O	Length
1	Length of SimpleIP User Profile Parameter Block			M	1 byte
2 – X+1	See [7], SimpleIP User Profile Parameter Block			M	X bytes

5

6 This EF is stored using the convention from [7], i.e. fields are placed into octets starting with the  
7 MSB of the first field into bit 8 of the first octet, followed by the remaining fields placed in  
8 sequence into the remaining bits allocated for those fields. A multi-octet integer is stored by  
9 placing the octet with the MSB into the lowest numbered available octet allocated for that integer  
10 in the EF.

1 **5.2.44 EF<sub>MIPUPP</sub> (Mobile IP User Profile Parameters)**

2 If service n15 is available (see Section 5.2.18), this EF shall be present. This EF stores the  
3 MobileIP User Profile Parameter Block defined in [7].

4

Identifier: '6F4D'		Structure: transparent		Optional	
File size: 1+X			Update activity: low		
Access Conditions:					
READ		PIN			
UPDATE		ADM			
INVALIDATE		ADM			
REHABILITATE		ADM			
Bytes	Description		M/O	Length	
1	Length of MobileIP User Profile Parameter Block		M	1 byte	
2 – X+1	See [7], MobileIP User Profile Parameter Block		M	X bytes	

5

6 This EF is stored using the convention from [7], i.e. fields are placed into octets starting with the  
7 MSB of the first field into bit 8 of the first octet, followed by the remaining fields placed in  
8 sequence into the remaining bits allocated for those fields. A multi-octet integer is stored by  
9 placing the octet with the MSB into the lowest numbered available octet allocated for that integer  
10 in the EF.

1 **5.2.45 EF<sub>SIPSP</sub> (Simple IP Status Parameters)**

2 If service n14 is available (see Section 5.2.18), this EF shall be present. This EF stores the  
3 SimpleIP Status Parameters Block defined in [7].

4

Identifier: '6F4E'		Structure: transparent		Optional	
File size: 1			Update activity: low		
Access Conditions:					
READ		PIN			
UPDATE		PIN			
INVALIDATE		ADM			
REHABILITATE		ADM			
Bytes	Description			M/O	Length
1	See [7], SimpleIP Status Parameters Block			M	1 byte

5

6 This EF is stored using the convention from [7], i.e. fields are placed into octets starting with the  
7 MSB of the first field into bit 8 of the first octet, followed by the remaining fields placed in  
8 sequence into the remaining bits allocated for those fields. A multi-octet integer is stored by  
9 placing the octet with the MSB into the lowest numbered available octet allocated for that integer  
10 in the EF.

1 **5.2.46 EF<sub>MIPSP</sub> (Mobile IP Status Parameters)**

2 If service n15 is available (see Section 3.4.18), this EF shall be present. This EF stores the  
 3 MobileIP Status Parameters Block defined in [7].

4

Identifier: '6F4F'		Structure: transparent		Optional	
File size: X			Update activity: low		
Access Conditions:					
READ		PIN			
UPDATE		PIN			
INVALIDATE		ADM			
REHABILITATE		ADM			
Bytes	Description			M/O	Length
1 – X	See [7], MobileIP Status Parameters Block			M	X bytes

5

6 This EF is stored using the convention from [7], i.e. fields are placed into octets starting with the  
 7 MSB of the first field into bit 8 of the first octet, followed by the remaining fields placed in  
 8 sequence into the remaining bits allocated for those fields. A multi-octet integer is stored by  
 9 placing the octet with the MSB into the lowest numbered available octet allocated for that integer  
 10 in the EF.

1 **5.2.47 EF<sub>SIPPAPSS</sub> (Simple IP PAP SS Parameters)**

2 If service n14 is available (see Section 3.4.18), this EF shall be present. This EF stores the  
3 SimpleIP PAP SS Parameter Block defined in [7].

4

Identifier: '6F50'		Structure: transparent		Optional	
File size: 1+X			Update activity: low		
Access Conditions:					
READ		PIN			
UPDATE		PIN			
INVALIDATE		ADM			
REHABILITATE		ADM			
Bytes	Description	M/O	Length		
1	Length of SimpleIP PAP SS Parameter Block	M	1 byte		
2 – X+1	See [7], SimpleIP PAP SS Parameter Block	M	X bytes		

5

6 This EF is stored using the convention from [7], i.e. fields are placed into octets starting with the  
7 MSB of the first field into bit 8 of the first octet, followed by the remaining fields placed in  
8 sequence into the remaining bits allocated for those fields. A multi-octet integer is stored by  
9 placing the octet with the MSB into the lowest numbered available octet allocated for that integer  
10 in the EF.

1 **5.2.48 Reserved**

2 **5.2.49 Reserved**

1 **5.2.50 EF<sub>PUZL</sub> (Preferred User Zone List)**

2 This EF stores the Preferred User Zone List, as described in Section 3.5.7 of [7].

3

Identifier: '6F53'	Structure: transparent	Optional	
File size: 'MAX_UZ_LIST_SIZE'	Update activity: low		
Access Conditions:			
READ	PIN		
UPDATE	ADM		
INVALIDATE	ADM		
REHABILITATE	ADM		
Bytes	Description	M/O	Length
1- CUR_UZ_LIST_SIZE	PUZL (see Section 3.5.7 of [7])	M	CUR_UZ_LIST_SIZE

4

5 This EF is stored using the convention from [7], i.e. fields are placed into octets starting with the  
6 MSB of the first field into bit 8 of the first octet, followed by the remaining fields placed in  
7 sequence into the remaining bits allocated for those fields. A multi-octet integer is stored by  
8 placing the octet with the MSB into the lowest numbered available octet allocated for that integer  
9 in the EF.

1 **5.2.51 EF<sub>MAXPUZL</sub> (Maximum PUZL)**

2 This EF stores the maximum size, in octets, that the CSIM can support for EF<sub>PUZL</sub> (See 3.5.7 of [7]  
 3 for more details) and the maximum number of User Zone entries that the CSIM can support for  
 4 EF<sub>PUZL</sub> (See 3.5.6.1 of [7] for more details).

5

Identifier: '6F54'		Structure: transparent		Optional	
File size: 5 bytes			Update activity: Never		
Access Conditions:					
READ		PIN			
UPDATE		ADM			
INVALIDATE		ADM			
REHABILITATE		ADM			
Bytes	Description			M/O	Length
1 -3	MAX_UZ_LIST_SIZE			M	3 bytes
4 - 5	MAX_NUM_UZ			M	2 bytes

6  
 7 This EF is stored using the convention from [7], i.e. fields are placed into octets starting with the  
 8 MSB of the first field into bit 8 of the first octet, followed by the remaining fields placed in  
 9 sequence into the remaining bits allocated for those fields. A multi-octet integer is stored by  
 10 placing the octet with the MSB into the lowest numbered available octet allocated for that integer  
 11 in the EF.

12 Coding:

13 Octet 1:

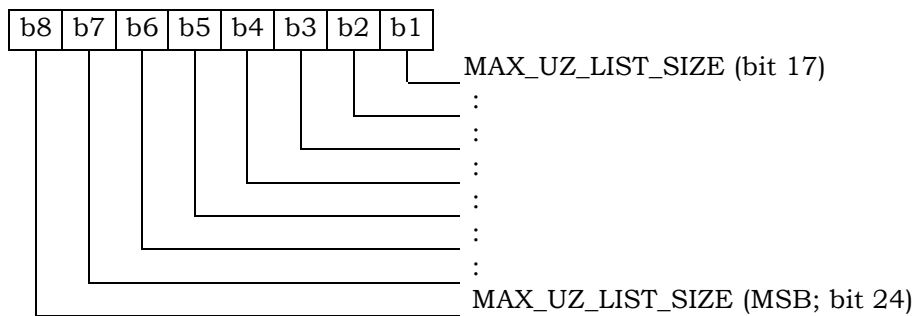

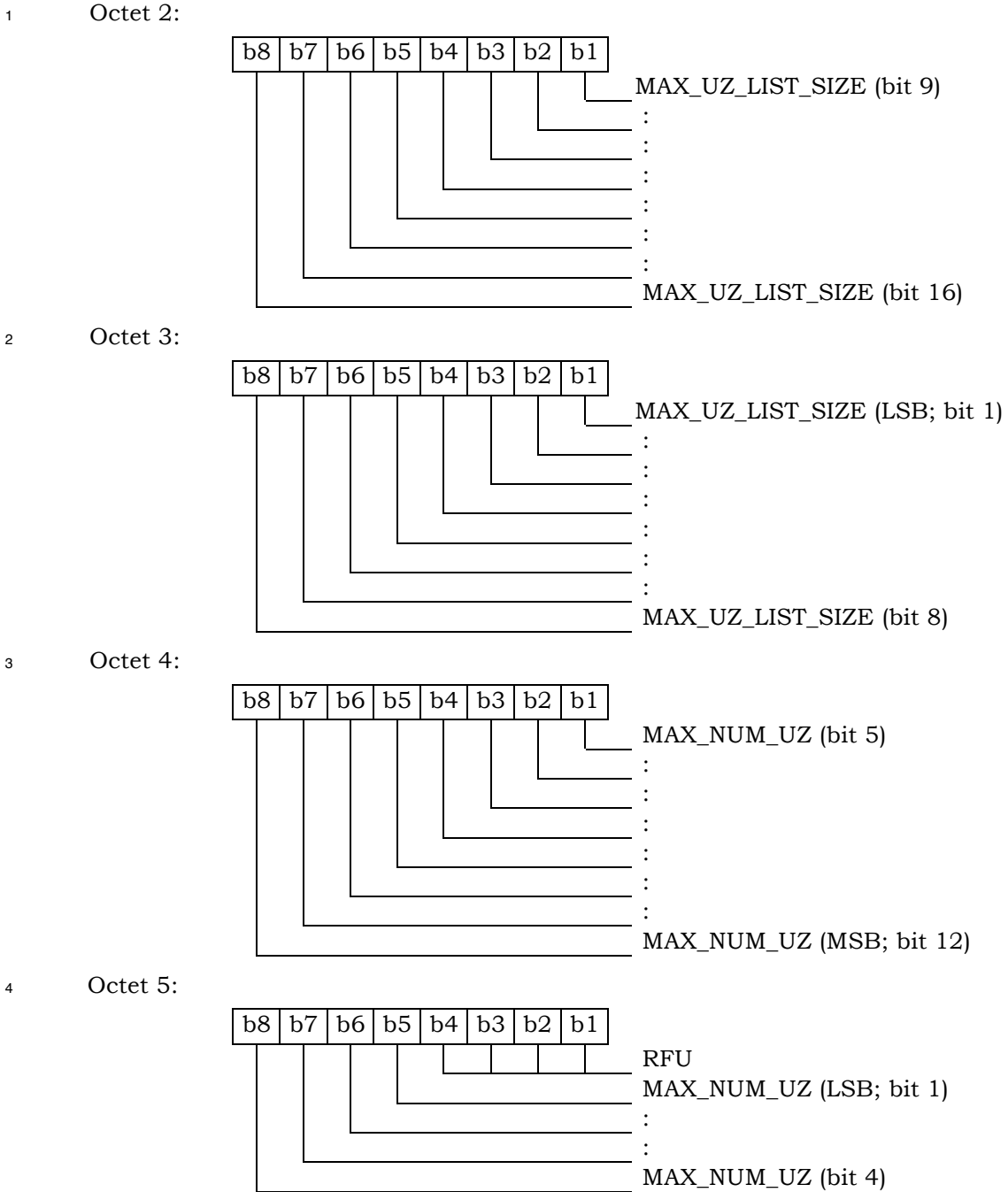

1 **5.2.52 EF<sub>MECRP</sub> (ME-specific Configuration Request Parameters)**

2 This EF stores ME-specific parameters to be used to form the response to the CONFIGURATION  
 3 REQUEST command while secure mode is active. The ME shall update these ME-specific  
 4 parameters during initializations.

Identifier: '6F55'		Structure: transparent		Mandatory	
File size: 3 bytes			Update activity: medium		
Access Conditions:					
READ		PIN			
UPDATE		PIN			
INVALIDATE		ADM			
REHABILITATE		ADM			
Bytes	Description			M/O	Length
1	SCM			M	1 byte
2	MOB_P_REV			M	1 byte
3	Local Control			M	1 byte

6  
 7 Coding:

8 Byte 1:

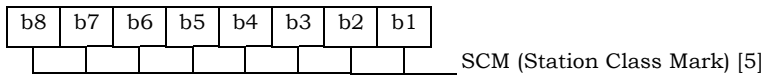

9  
 10 Note: b6 indicates if the ME is operating in slotted mode.

11  
 12  
 13 Byte 2:

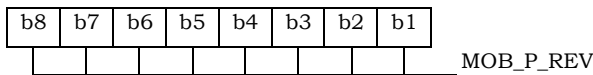

14  
 15  
 16 Byte 3:

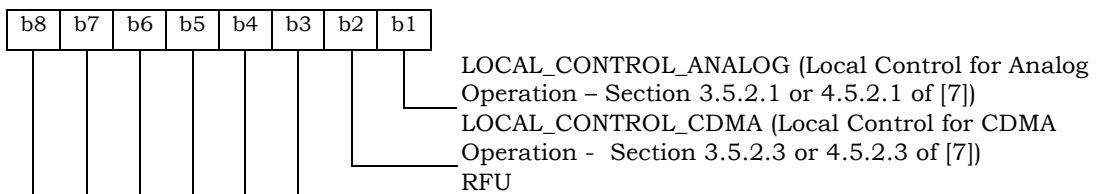

1 **5.2.53 EF<sub>HRPDCAP</sub> (HRPD Access Authentication Capability Parameters)**

2 If service n8 is available (see Section 5.2.18), this EF shall be present. This EF stores the HRPD  
3 Access Authentication Capability Parameters Block defined in Section 3.5.8.12 of [7].

4

Identifier: '6F56'		Structure: transparent		Optional	
File size: 3 bytes			Update activity: low		
Access Conditions:					
READ		PIN			
UPDATE		ADM			
INVALIDATE		ADM			
REHABILITATE		ADM			
Bytes	Description		M/O	Length	
1 – 3	See [7], HRPD Access Authentication Capability Parameters Block		M	3 bytes	

5

6 This EF is stored using the convention from [7], i.e. fields are placed into octets starting with the  
7 MSB of the first field into bit 8 of the first octet, followed by the remaining fields placed in  
8 sequence into the remaining bits allocated for those fields. A multi-octet integer is stored by  
9 placing the octet with the MSB into the lowest numbered available octet allocated for that integer  
10 in the EF.

1 **5.2.54 EF<sub>HRPDUPP</sub> (HRPD Access Authentication User Profile Parameters)**

2 If service n8 is available (see Section 5.2.18), this EF shall be present. This EF stores the HRPD  
3 Access Authentication User Profile Parameters Block defined in Section 3.5.8.13 of [7].

4

Identifier: '6F57'		Structure: transparent		Optional	
File size: 1+X bytes			Update activity: low		
Access Conditions:					
READ		PIN			
UPDATE		ADM			
INVALIDATE		ADM			
REHABILITATE		ADM			
Bytes	Description	M/O	Length		
1	Length of HRPD Access Authentication User Profile Parameters Block	M	1 byte		
2 – X+1	See [7], HRPD Access Authentication User Profile Parameters Block	M	X bytes		

5

6 This EF is stored using the convention from [7], i.e. fields are placed into octets starting with the  
7 MSB of the first field into bit 8 of the first octet, followed by the remaining fields placed in  
8 sequence into the remaining bits allocated for those fields. A multi-octet integer is stored by  
9 placing the octet with the MSB into the lowest numbered available octet allocated for that integer  
10 in the EF.

### 5.2.55 EF<sub>CSSPR</sub> (CUR\_SSPR\_P\_REV)

This EF stores the protocol revision (CUR\_SSPR\_P\_REV) of the current extended preferred roaming list stored in the EF<sub>EPRL</sub>. This information, described in Section 3.5.3.3 of [7], is used by the ME to parse the EF<sub>EPRL</sub>.

Identifier: '6F58'		Structure: transparent		Optional	
File size: 1			Update activity: low		
Access Conditions:					
READ		PIN			
UPDATE		ADM			
INVALIDATE		ADM			
REHABILITATE		ADM			
Bytes	Description			M/O	Length
1	CUR_SSPR_P_REV			M	1 byte

#### Notes:

1. It is recommended that CUR\_SSPR\_P\_REV in Octet 7 of EF<sub>EPRL</sub> (as defined in section 3.5.3.3 of [7]) be used instead of this EF<sub>CSSPR</sub>.
2. According to [7], CUR\_SSPR\_P\_REV is used to indicate if the PRL or EPRL is stored in PR\_LISTs-p and according to section 3.3.1.3 of [7], the MS shall store CUR\_SSPR\_P\_REV for not only the PRL but also the EPRL after an SSPR Download Request. However, since a CSIM can store the PRL and EPRL in EF<sub>PRL</sub> and EF<sub>EPRL</sub>, respectively, there is no need to distinguish what is stored in EF<sub>PRL</sub>. Hence, EF<sub>CSSPR</sub> is only applicable for EF<sub>EPRL</sub> and not EF<sub>PRL</sub> as [7] would seem to require.

1 **5.2.56 EF<sub>ATC</sub> (Access Terminal Class)**

2 If service n8 is available (see Section 5.2.18), this EF shall be present. This EF stores the class of  
 3 access terminal used for Persistence Test in the system defined in [28].

4

Identifier: '6F59'		Structure: transparent		Optional	
File size: 1			Update activity: low		
Access Conditions:					
READ		PIN			
UPDATE		ADM			
INVALIDATE		ADM			
REHABILITATE		ADM			
Bytes	Description			M/O	Length
1	Access Terminal Class			M	1 byte

5

6 Coding:

7

Byte 1:

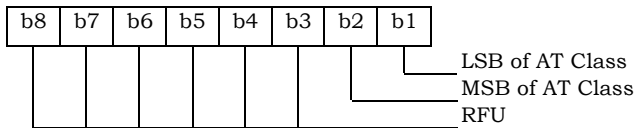

8

### 5.2.57 EF<sub>EPRL</sub> (Extended Preferred Roaming List)

This EF stores the Extended Preferred Roaming List, as described in Section 3.5.5 of [7].

Identifier: '6F5A'	Structure: transparent	Optional	
SFI: '0E'			
File size: MAX_PR_LIST_SIZE for EF <sub>EPRL</sub>	Update activity: low		
Access Conditions:			
READ	PIN		
UPDATE	ADM		
INVALIDATE	ADM		
REHABILITATE	ADM		
Bytes	Description	M/O	Length
1-PR_LIST_SIZE	PR_LIST (see Section 3.5.5 of [7])	M	PR_LIST_SIZE

This EF is stored using the convention from [7], i.e. fields are placed into octets starting with the MSB of the first field into bit 8 of the first octet, followed by the remaining fields placed in sequence into the remaining bits allocated for those fields. A multi-octet integer is stored by placing the octet with the MSB into the lowest numbered available octet allocated for that integer in the EF.

- PR\_LIST

Contents:

The Extended Preferred Roaming List.

Coding:

As defined in section 3.5.5 of [7].

1 **5.2.58 EF<sub>BCSMScfg</sub> (Broadcast Short Message Configuration)**

2 If service n9 is available, this EF shall be present.

3 This EF contains the operator broadcast configuration setting for Broadcast SMS. This  
 4 information, determined by the operator, defines the filtering criteria that can be used by the ME  
 5 to receive Broadcast SMS.

6

Identifier: '6F5B'		Structure: transparent		Optional	
File size: 1 byte			Update activity: low		
Access Conditions:					
READ		PIN			
UPDATE		ADM			
INVALIDATE		ADM			
REHABILITATE		ADM			
Bytes	Description			M/O	Length
1	Operator Broadcast Configuration			M	1 byte

7

8 Coding:

9

Byte 1:

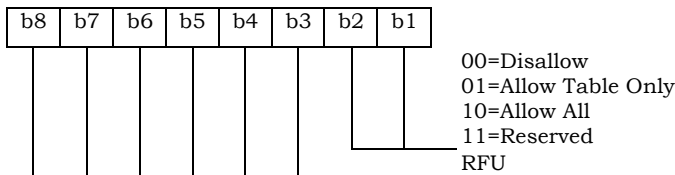

10

11

12

Operator configuration includes filtering criteria imposed by a service provider.

Field Name	Description
Disallow	This setting disables the mobile station's broadcast SMS capability (i.e., the mobile station will not process broadcast SMS).
Allow Table Only	This setting allows the mobile station to receive only broadcast messages for the service categories that have been programmed in EF <sub>BCSMSstable</sub>
Allow All	This setting allows the mobile station to receive broadcast messages for all service categories.

1 **5.2.59 EF<sub>BCSMSPref</sub> (Broadcast Short Message Preference)**

2 If service n9 is available, this EF shall be present.

3 This EF contains the user broadcast configuration setting for Broadcast SMS. This information,  
 4 determined by the user, defines the filtering criteria that can be used by the Mobile Equipment  
 5 (ME) to receive Broadcast SMS.

6

Identifier: '6F5C'		Structure: transparent		Optional	
File size: 1 byte			Update activity: high		
Access Conditions:					
READ		PIN			
UPDATE		PIN			
INVALIDATE		ADM			
REHABILITATE		ADM			
Bytes	Description			M/O	Length
1	User Broadcast Configuration			M	1 byte

7

8 Coding:

9 Byte 1:

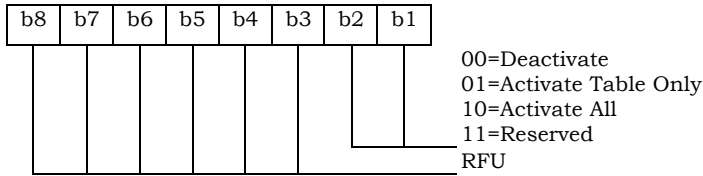

10

11 User configuration includes filtering criteria determined by the mobile user.

Field Name	Description
Deactivate	This setting deactivates the mobile station's broadcast SMS functions (i.e., the mobile station will not process broadcast SMS).
Activate Table Only	This setting allows the mobile station to receive only broadcast messages for the service categories that have been programmed in EFBCSMStable, subject to any additional filtering criteria included in EFBCSMStable based on user preferences. This setting is only valid if the operator configuration is not Disallow. Moreover, the mobile user can selectively enable and disable individual programmed entries in EFBCSMStable.
Activate All	This setting allows the mobile station to receive broadcast messages for all service categories. This setting is only valid if the operator configuration is "Allow All". EFBCSMStable will not be consulted for this setting.

1 **5.2.60 EF<sub>BCSMStable</sub> (Broadcast Short Message Table)**

2 If service n9 is available, this EF shall be present.

3 This EF contains information in accordance with [8] comprising service category program  
 4 parameters, which can be used by the Mobile Equipment (ME) for Broadcast SMS filtering. See  
 5 Section 4.5.19 of [8] for more detail.

6 Each record in this EF is linked to a record with the same record index in EF<sub>BCSMSP</sub>.

7

Identifier: '6F5D'		Structure: linear fixed		Optional	
Record Length: 7+X byte			Update activity: high		
Access Conditions:					
READ		PIN			
UPDATE		ADM			
INVALIDATE		ADM			
REHABILITATE		ADM			
Bytes	Description	M/O	Length		
1	Status	M	1 byte		
2 – 3	Service Category	M	2 bytes		
4	Language	M	1 byte		
5	Max Messages	M	1 byte		
6	Alert Option	M	1 byte		
7	Label Encoding	M	1 byte		
8 to 7+X	Label	M	X byte		

8

9 - Status

9

10 Contents:

10

11 Status byte of the record which can be used as a pattern in the SEEK command.

12

13 Coding:

13

14 Byte 1:

14

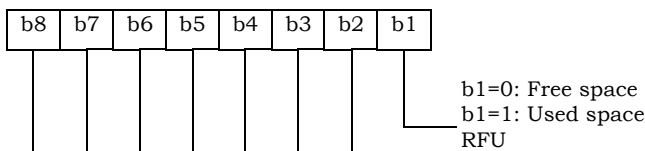

15

1

Byte 2:

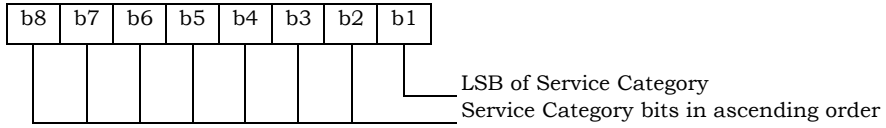

2

3

Byte 3:

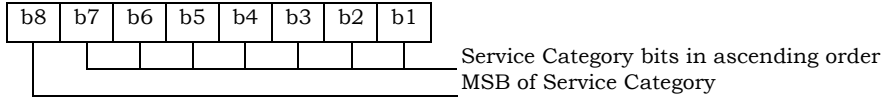

4

5

Byte 4:

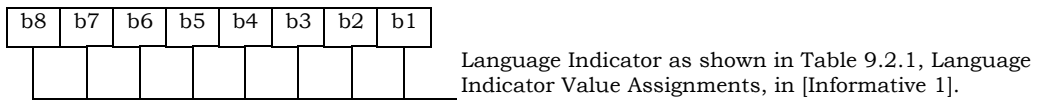

6

7

Byte 5:

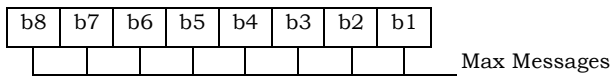

8

9

Byte 6:

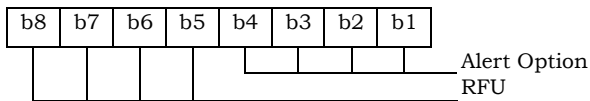

10

11

Byte 7:

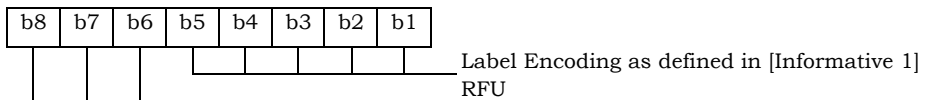

12

13

1 **5.2.61 EF<sub>BCSMSP</sub> (Broadcast Short Message Parameter)**

2 If service n9 is available, this EF shall be present.

3 This EF contains selection flag and priority associated with service categories and used by the ME  
 4 for filtering of BC-SMS. Each record in this EF is linked to a record with the same record index in  
 5 EF<sub>BCSMStable</sub>.

6

Identifier: '6F5E'		Structure: linear fixed		Optional	
Record Length: 2 bytes			Update activity: high		
Access Conditions:					
READ		PIN			
UPDATE		PIN			
INVALIDATE		ADM			
REHABILITATE		ADM			
Bytes	Description			M/O	Length
1	Select			M	1 byte
2	Priority			M	1 byte

7

8 Coding:

9

Byte 1:

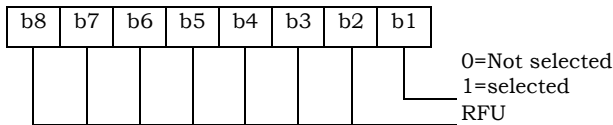

10

11

Byte 2:

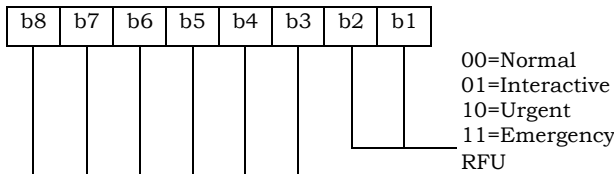

12 Unused records are filled with 'FF'. When the b1 of Byte 1 is set to '1', then the ME shall filter the  
 13 BC-SMS according to the priority indicated in Byte 2.

### 5.2.62 EF<sub>BAKPARA</sub> (Currently used BAK Parameters)

If service n18 is available, this EF shall be present.

This EF contains BCMCS related parameters, i.e.: BCMCS\_Flow\_ID, BAK\_ID and BAK\_Expire, corresponding to BAK keys that have been delivered to the CSIM and are currently used. See [36] for more details.

Identifier: '6F63'		Structure: Linear Fixed		Optional	
Record length: X+Y+Z+3 bytes			Update activity: high		
Access Conditions:					
READ		PIN			
UPDATE		ADM			
DEACTIVATE		ADM			
ACTIVATE		ADM			
Bytes	Description	M/O	Length		
1	Length of BCMCS_Flow_ID	M	1 byte		
2 to X +1	BCMCS_Flow_ID	M	X bytes		
X+2	Length of BAK_ID	M	1 byte		
X+3 to X+Y+2	BAK_ID	M	Y bytes		
X+Y+3	Length of BAK_Expire	M	1 byte		
X+Y+4 to X+Y+Z+3	BAK_Expire	M	Z bytes		

- Length of BCMCS\_Flow\_ID

Content: number of bytes of the following data item containing the BCMCS flow identifier.

Coding: Binary.

- BCMCS\_Flow\_ID

Content: BCMCS Flow Identifier

Coding: Binary.

- Length of BAK\_ID

Content: number of bytes of the following data item containing the BAK identifier.

Coding: Binary

- 1       - BAK\_ID
- 2           Content: BAK Identifier
- 3           Coding: Binary.
- 4
- 5       - Length of BAK\_Expire
- 6           Content: number of bytes of the following data item containing the BAK\_Expire.
- 7           Coding: Binary
- 8
- 9       - BAK\_Expire
- 10          Content: BAK\_Expire
- 11          Coding: Binary.

### 5.2.63 EF<sub>UpBAKPARA</sub> (Updated BAK Parameters)

If service n18 is available, this EF shall be present.

This EF contains BCMCS related parameters, i.e.: BCMCS\_Flow\_ID, BAK\_ID and BAK\_Expire, corresponding to BAK keys that have been delivered to the CSIM but have not yet been used. See [36] for more details.

Identifier: '6F64'		Structure: cyclic		Optional	
Record length: X+Y+Z+3 bytes			Update activity: high		
Access Conditions:					
READ		PIN			
UPDATE		ADM			
DEACTIVATE		ADM			
ACTIVATE		ADM			
Bytes	Description	M/O	Length		
1	Length of BCMCS_Flow_ID	M	1 byte		
2 to X +1	BCMCS_Flow_ID	M	X bytes		
X+2	Length of BAK_ID	M	1 byte		
X+3 to X+2+Y	BAK_ID	M	Y bytes		
X+Y+3	Length of BAK_Expire	M	1 byte		
X+Y+4 to X+Y+Z+3	BAK_Expire	M	Z bytes		

- Length of BCMCS\_Flow\_ID

Content: number of bytes of the following data item containing the BCMCS flow identifier.

Coding: Binary

- BCMCS\_Flow\_ID

Content: BCMCS Flow Identifier

Coding: Binary.

- Length of BAK\_ID

Content: number of bytes of the following data item containing the BAK identifier.

Coding: Binary

- 1       - BAK\_ID
- 2           Content: BAK Identifier
- 3           Coding: Binary.
- 4
- 5       - Length of BAK\_Expire
- 6           Content: number of bytes of the following data item containing the BAK\_Expire.
- 7           Coding: Binary
- 8
- 9       - BAK\_Expire
- 10          Content: BAK\_Expire
- 11          Coding: Binary.

1 **5.2.64 EF<sub>MMSN</sub> (MMS Notification)**

2 If service n19 is available, this file shall be present.

3 This EF contains information in accordance with [37] comprising MMS notifications (and  
4 associated parameters) which have been received by the ME from the network.

5

Identifier: '6F65'		Structure: Linear fixed		Optional
Record length: X bytes			Update activity: low	
Access Conditions:				
READ		PIN		
UPDATE		PIN		
INVALIDATE		ADM		
REHABILITATE		ADM		
Bytes	Description	M/O	Length	
1 - 2	MMS Status	M	2 bytes	
3	MMS Implementation	M	1 byte	
4 to Y+3	MMS Notification	M	Y bytes	
Y+4	Extension file record number	M	1 byte	

6

7 Note:  $X \geq Y+4$  for every record.

8 - MMS Status

9 Content:

10 The status bytes contain the status information for the notification.

1

Octet 1:

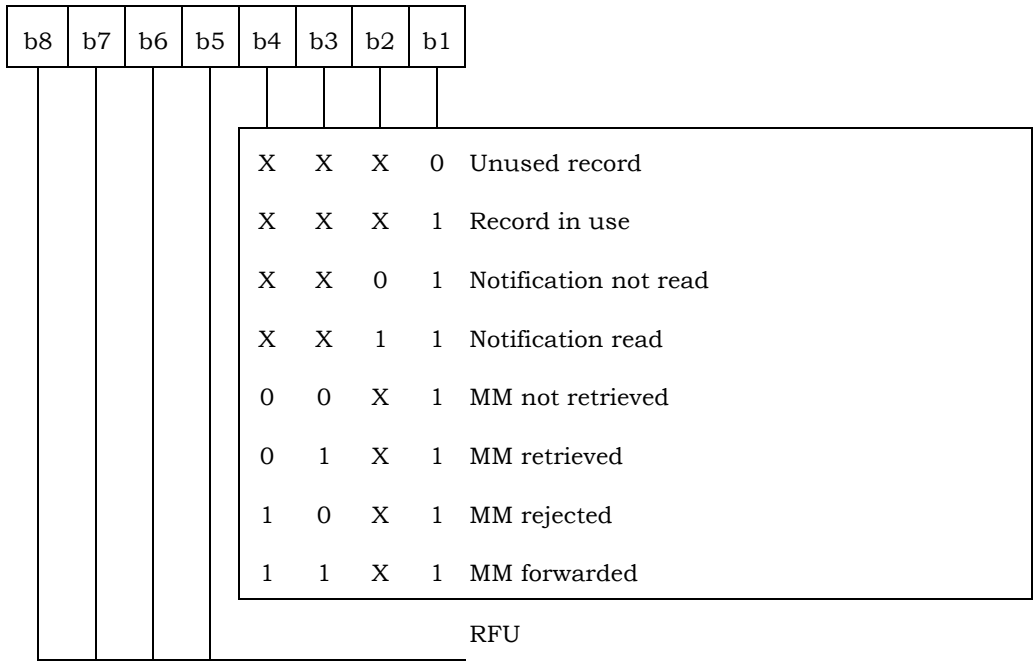

2

3

Octet 2:

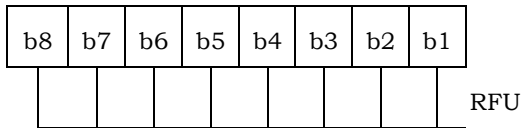

4

5

- MMS Implementation

6

Contents:

7

The MMS Implementation indicates the used implementation type, e.g. WAP, M-IMAP, SIP.

8

Octet 3:

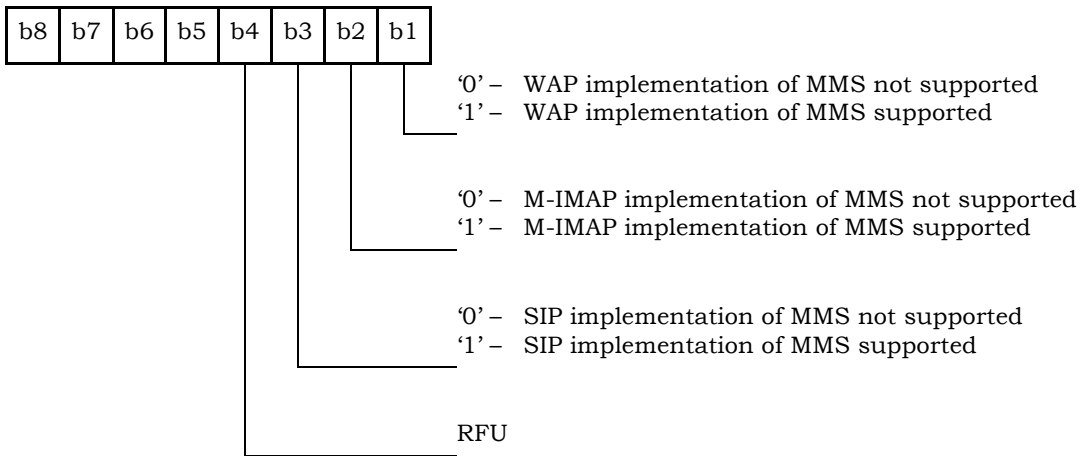

9

10

- 1           - MMS Notification
- 2            Contents:
- 3             The MMS Notification contains the MMS notification.
- 4            Coding:
- 5             The MMS Notification is coded according to the MMS Implementation as indicated in octet 3.
- 6             Any unused octets shall be set to 'FF'.
- 7
- 8           - Extension file record number
- 9            Contents:
- 10            - extension file record number. This octet identifies the number of a record in the EF<sub>EXTS</sub> containing
- 11            extension data for the notification information. The use of this octet is optional. If it is not used it
- 12            shall be set to 'FF'.
- 13            Coding:
- 14            - binary.
- 15

1 **5.2.65 EF<sub>EXT8</sub> (Extension 8)**

2 If service n20 is available, this file shall be present.

3 This EF contains extension data of a MMS Notification (Multimedia Messaging Service).

4

Identifier: '6F66'		Structure: linear fixed		Optional	
Record length: X+2 bytes			Update activity: low		
Access Conditions:					
READ		PIN			
UPDATE		PIN			
INVALIDATE		ADM			
REHABILITATE		ADM			
Bytes	Description	M/O	Length		
1	Record type	M	1 byte		
2 to X+1	Extension data	M	X bytes		
X+2	Identifier	M	1 byte		

5

6 For contents and coding see [30].

1 **5.2.66 EF<sub>MMSICP</sub> (MMS Issuer Connectivity Parameters)**

2 If service n19 is available, this file shall be present.

3 This EF contains values for Multimedia Messaging Connectivity Parameters as determined by the  
4 issuer, which can be used by the ME for MMS network connection. This file may contain one or  
5 more sets of Multimedia Messaging Issuer Connectivity Parameters. The first set of Multimedia  
6 Messaging Issuer Connectivity Parameters is used as the default set.

7 Each set of Multimedia Messaging Issuer Connectivity Parameters may consist of one or more  
8 "Interface to Core Network and Bearer information" TLV objects (only for WAP), but shall contain  
9 only one "MMS Implementation" TLV object (for WAP, M-IMAP and SIP), one "MMS Relay/Server"  
10 TLV object (for WAP, M-IMAP and SIP) and one "Gateway" TLV object (only for WAP).

11 The order of the "Interface to Core Network and Bearer information" TLV objects in the MMS  
12 Connectivity TLV object defines the priority of the Interface to Core Network and Bearer  
13 information, with the first TLV object having the highest priority.

14

Identifier: '6F67'	Structure: Transparent	Optional	
File Size: $X_1 + \dots + X_n$ bytes		Update activity: low	
Access Conditions:			
READ	PIN		
UPDATE	ADM		
INVALIDATE	ADM		
REHABILITATE	ADM		
Bytes	Description	M/O	Length
1 to $X_1$	MMS Connectivity Parameters TLV object	M	$X_1$ bytes
$X_1+1$ to $X_1 + X_2$	MMS Connectivity Parameters TLV object	O	$X_2$ bytes
...	...		
$X_1 + \dots + X_{n-1} + 1$ to $X_1 + \dots + X_n$	MMS Connectivity Parameters TLV object	O	$X_n$ bytes

1 - MMS Connectivity Parameters tags

Description	Tag Value
MMS Connectivity Parameters Tag	'AB'
MMS Implementation Tag	'80'
MMS Relay/Server Tag	'81'
Interface to Core Network and Bearer Information Tag	'82'
Gateway Tag	'83'
MMS Authentication Mechanism Tag	'84'
MMS Authentication ID Tag	'85'

2

## 1 - MMS Connectivity Parameters contents

Description	Value	M/O	Length (bytes)
MMS Connectivity Parameters Tag	'AB'	M	1
Length	Note 1	M	Note 2
MMS Implementation Tag	'80'	M	1
Length	1	M	1
MMS Implementation Information	--	M	1
MMS Relay/Server Tag	'81'	M	1
Length	X	M	Note 2
MMS Relay/Server Address	--	M	X
First Interface to Core Network and Bearer Information Tag (highest priority)	'82'	C2	1
Length	Y1	C2	Note 2
First Interface to Core Network and Bearer information	--	C2	Y1
Second Interface to Core Network and Bearer Information Tag	'82'	C2	1
Length	Y2	C2	Note 2
Second Interface to Core Network and Bearer information	--	C2	Y2
...			
N <sup>th</sup> Interface to Core Network and Bearer Information Tag (lowest priority)	'82'	C2	1
Length	Y3	C2	Note 2
N <sup>th</sup> Interface to Core Network and Bearer information	--	C2	Y3
Gateway Tag	'83'	O	1
Length	Z	O	Note 2
Gateway Information	--	O	Z
MMS Authentication Mechanism Tag	'84'	C1	1
Length	X	C1	Note 2
MMS Authentication Mechanism	--	C1	X
MMS Authentication ID Tag	'85'	C1	1
Length	X	C1	Note 2
MMS Authentication ID (Login_ID)	--	C1	X
NOTE 1: This is the total size of the constructed TLV object (not including the tag and this length).			
NOTE 2: The length is coded according to [60] using primitive encoding and the minimum number of octets.			
C1: only present if M-IMAP or SIP indicated in tag 80			
C2: only present if WAP is indicated in tag 80			

1 - MMS Implementation Tag '80'

2 See [30] for contents and coding.

3  
4 - MMS Relay/server Tag '81'

5 Contents:

6 The MMS relay/server contains the address of the associated MMS relay/server; In  
7 addition, for M-IMAP and SIP, authentication mechanism and authentication ID (Login  
8 ID) are also included.

9 Coding:

10 The MMS relay/server address is coded as URI appropriate to the MM1 implementation  
11 being used, for example SIP, or M-IMAP.

12  
13 - Interface to Core Network and Bearer Information Tag '82'

14 Contents:

15 The Interface to Core Network and Bearer Information may contain the following  
16 information to set up the bearer: Bearer, Address, Type of address, Speed, Call type,  
17 Authentication type, Authentication id, Authentication password.

18 Coding:

19 The coding is according to the guideline provided in [37]. If MMS implementation type is  
20 WAP, all instances of Interface to Core Network and Bearer Information are optional. If  
21 MMS implementation type is M-IMAP or SIP, no Interface to Core Network and Bearer  
22 Information is needed.

23  
24 - Gateway Tag '83'

25 Contents:

26 The Gateway may contain the following information; Address, Type of address, Port,  
27 Service, Authentication type, Authentication id and Authentication password.

28 Coding:

29 The coding is according to the guideline provided in [37].

30  
31 - MMS Authentication Mechanism Tag '84'

32 Contents:

33 The MMS authentication mechanism contains the authentication mechanism for MMS. It  
34 is mandatory for M-IMAP and SIP.

35 Coding:

36 The MMS authentication mechanism is coded as in Section 4.10.1 of [46].

37  
38 - MMS Authentication ID Tag '85'

39 Contents:

40 The MMS authentication ID contains the authentication ID for MMS. It is mandatory for  
41 M-IMAP and SIP.

42 Coding:

43 The coding is according to the guideline provided in [37].

44  
45 Unused bytes shall be set to 'FF'.

1 **5.2.67 EF<sub>MMSUP</sub> (MMS User Preferences)**

2 If service n19 is available, this file shall be present.

3 This EF contains values for Multimedia Messaging Service User Preferences, which can be used  
4 by the ME for user assistance in preparation of mobile multimedia messages (e.g. default values  
5 for parameters that are often used).

6

Identifier: '6F68'	Structure: Linear Fixed	Optional	
Record Length: X bytes	Update activity: low		
Access Conditions:			
READ	PIN		
UPDATE	PIN		
INVALIDATE	ADM		
REHABILITATE	ADM		
Bytes	Description	M/O	Length
1 to X	MMS User Preference TLV Objects	M	X bytes

7

8

- MMS User Preference tags

Description	Tag Value
MMS Implementation Tag	'80'
MMS User preference profile name Tag	'81'
MMS User Preference information Tag	'82'

9

## 1 - MMS User Preference information

Description	Value	M/O	Length (bytes)
MMS Implementation Tag	'80'	M	1
Length	1	M	1
MMS Implementation information	--	M	1
MMS User preference profile name Tag	'81'	M	1
Length	Y	M	Note
MMS User profile name	--	M	Y
MMS User Preference information Tag	'82'	M	1
Length	Z	M	Note
MMS User Preference information	--	M	Z
NOTE: The length is coded according to [60] using primitive encoding and the minimum number of octets.			

2

3

## - MMS Implementation Tag '80'

4

For contents and coding see [30].

5

6

## - MMS User preference profile name Tag '81'

7

Contents:

8

Alpha tagging of the MMS user preference profile.

9

Coding:

10

This alpha-tagging shall use either:

11

- the SMS default 7-bit coded alphabet as defined in [38] with bit 8 set to 0. The alpha identifier shall be left justified; or
- one of the UCS2 coded options as defined in the annex of [30].

12

13

14

15

## - MMS User Preference information Tag '82'

16

Contents:

17

The following information elements may be coded; Sender Visibility, Delivery Report, Read-Reply, Priority, Time of Expiry and Earliest Delivery Time. Refer to [37], [39], [40], and [41].

18

19

20

Coding:

21

Depending upon the MMS implementation as indicated in Tag '80'.

22

1 **5.2.68 EF<sub>MMSUCP</sub> (MMS User Connectivity Parameters)**

2 If service n19 and n21 are available, this file shall be present.

3 This EF contains values for Multimedia Messaging Connectivity Parameters as determined by the  
4 user, which can be used by the ME for MMS network connection. This file may contain one or more  
5 sets of Multimedia Messaging User Connectivity Parameters.

6 Each set of Multimedia Messaging User Connectivity Parameters may consist of one or more  
7 "Interface to Core Network and Bearer information" TLV objects (only for WAP), but shall contain only  
8 one "MMS Implementation" TLV object (for WAP, M-IMAP and SIP), one "MMS Relay/Server" TLV  
9 object (for WAP, M-IMAP and SIP) and one "Gateway" TLV object (only for WAP).

10 The order of the "Interface to Core Network and Bearer information" TLV objects in the MMS  
11 Connectivity TLV object defines the priority of the Interface to Core Network and Bearer information,  
12 with the first TLV object having the highest priority.

Identifier: '6F69'		Structure: Transparent		Optional	
File Size: $X_1 + \dots + X_n$ bytes			Update activity: low		
Access Conditions:					
READ		PIN			
UPDATE		PIN/PIN2 (fixed during administrative management)			
INVALIDATE		ADM			
REHABILITATE		ADM			
Bytes		Description		M/O	Length
1 to $X_1$		MMS Connectivity Parameters TLV object		O	$X_1$ bytes
$X_1+1$ to $X_1 + X_2$		MMS Connectivity Parameters TLV object		O	$X_2$ bytes
...		...			
$X_1 + \dots + X_{n-1} + 1$ to $X_1 + \dots + X_n$		MMS Connectivity Parameters TLV object		O	$X_n$ bytes

13

14 For the contents and coding see Section 5.2.65 EF<sub>MMSICP</sub>.

1 **5.2.69 EF<sub>AuthCapability</sub> (Authentication Capability)**

2 If service n22 is available, this file shall be present. This EF stores authentication capabilities for  
 3 each application supported by the CSIM.  
 4

Identifier: '6F6A'		Structure: Linear Fixed		Optional
Record Length: 5 bytes		Update activity: low		
Access Conditions:				
READ		PIN		
UPDATE		ADM		
INVALIDATE		ADM		
REHABILITATE		ADM		
Bytes	Description	M/O	Length	
1	Application ID	M	1 byte	
2-3	Authentication Capability	M	2 bytes	
4-5	RFU	M	2 bytes	

5  
 6 Coding:

7 Byte 1:

8 The coding for Application ID is as follows:<sup>6</sup>

Binary Value	Application ID
'00000000'	MMS
'0000001'-'11111111'	Reserved

9

---

<sup>6</sup> Note that the Application ID for MMD is not listed for CSIM in contrast to [46] where it is listed – as MMD functions are defined in ISIM.

1

Byte 2:

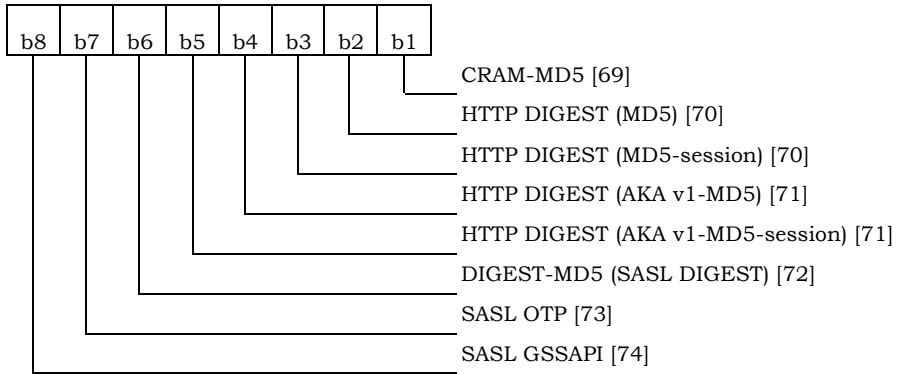

2

Byte 3:

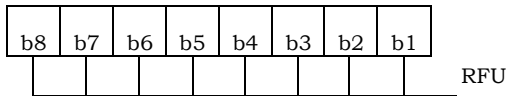

3

4 The CSIM shall set each subfield to '1' if it supports the corresponding authentication  
 5 mechanism.

1 **5.2.70 EF<sub>3GCIK</sub> (3G Cipher and Integrity Keys)**

2 If service n16 is available, this file shall be present.

3 This EF contains the cipher key (CK) and the integrity key (IK) produced by the '3G Access AKA'  
4 AUTHENTICATE command.

5

Identifier : '6F6B'		Structure : transparent		Optional	
SFI: '0B'					
File size: 32 bytes			Update activity: low		
Access Conditions:					
READ		PIN			
UPDATE		ADM			
INVALIDATE		ADM			
REHABILITATE		ADM			
Bytes	Description	M/O	Length		
1 - 16	Cipher key (CK)	M	16 bytes		
17 - 32	Integrity key (IK)	M	16 bytes		

6

7 - Cipher key (CK).

8 Coding:

9 The least significant bit of CK is the least significant bit of the 16<sup>th</sup> byte. The most  
10 significant bit of CK is the most significant bit of the 1<sup>st</sup> byte.

11

12 - Integrity key (IK).

13 Coding:

14 The least significant bit of IK is the least significant bit of the 32<sup>nd</sup> byte. The most  
15 significant bit of IK is the most significant bit of the 17<sup>th</sup> byte.

16

1 **5.2.71 EF<sub>DCK</sub> (De-Personalization Control Keys)**

2 If service n25 is available, this EF shall be present.

3 This EF provides storage for the de-personalization control keys associated with the OTA  
4 de-personalization cycle of [44].

5

Identifier: '6F6C'		Structure: transparent		Optional	
File size: 20 bytes			Update activity: low		
Access Conditions:					
READ		PIN			
UPDATE		PIN			
INVALIDATE		ADM			
REHABILITATE		ADM			
Bytes	Description			M/O	Length
1 to 4	8 digits of Network Type 1 de-personalization control key			M	4 bytes
5 to 8	8 digits of Network Type 2 de-personalization control key			M	4 bytes
9 to 12	8 digits of service provider de-personalization control key			M	4 bytes
13 to 16	8 digits of corporate de-personalization control key			M	4 bytes
17 to 20	8 digits of HRPD Network de-personalization control key			M	4 bytes

6 Empty control key fields shall be coded 'FFFFFFFF'.

1 **5.2.72 EF<sub>GID1</sub> (Group Identifier Level 1)**

2 If service n23 is available, this EF shall be present.

3 This EF contains identifiers for particular CSIM/ME associations. It can be used to identify a  
 4 group of CSIMs for a particular application.

5

Identifier: '6F6D'		Structure: transparent		Optional	
File size: 1 to n bytes			Update activity: low		
Access Conditions:					
READ		PIN			
UPDATE		ADM			
INVALIDATE		ADM			
REHABILITATE		ADM			
Bytes	Description			M/ O	Length
1 to n	CSIM group identifier(s)			O	n bytes

1 **5.2.73 EF<sub>GID2</sub> (Group Identifier Level 2)**

2 If service n24 is available, this EF shall be present.

3 This EF contains identifiers for particular CSIM/ME associations. It can be used to identify a  
4 group of CSIMs for a particular application.

5

Identifier: '6F6E'		Structure: transparent		Optional	
File size: 1 to n bytes			Update activity: low		
Access Conditions:					
READ		PIN			
UPDATE		ADM			
INVALIDATE		ADM			
REHABILITATE		ADM			
Bytes	Description			M/ O	Length
1 to n	CSIM group identifier(s)			O	n bytes

6

7 NOTE: The structure of EF<sub>GID1</sub> and EF<sub>GID2</sub> are identical. They are provided to allow the  
8 network operator to enforce different levels of security dependant on an application.

1 **5.2.74 EF<sub>CDMACNL</sub> (CDMA Co-operative Network List)**

2 If service n26 is available, this EF shall be present.

3 This EF contains the Co-operative Network List for the multiple network personalization services  
4 defined in [44].

5

Identifier: '6F6F'		Structure: transparent		Optional	
File size: 7n bytes			Update activity: low		
Access Conditions:					
READ		PIN			
UPDATE		ADM			
INVALIDATE		ADM			
REHABILITATE		ADM			
Bytes	Description			M/O	Length
1 to 7	Element 1 of co-operative net list			M	7 bytes
...					
7n-6 to 7n	Element n of co-operative net list			O	7 bytes

6

7 - Co-operative Network List

8 Contents:

9 Service provider ID and corporate ID of co-operative networks.

10 Coding:

11 For each 7 byte list element:

12 Byte 1 to 3: MCC + MNC: As per Annex A of [9].

13 Byte 4 to 5: 4 most significant digits of the International Roaming based MIN.

14

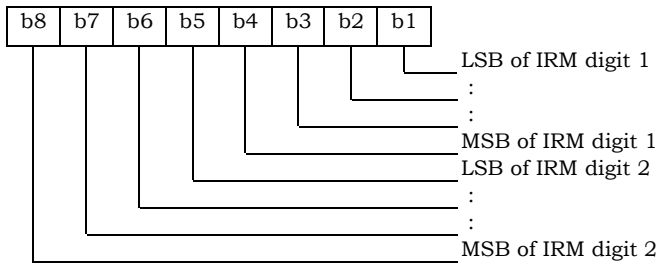

15

16

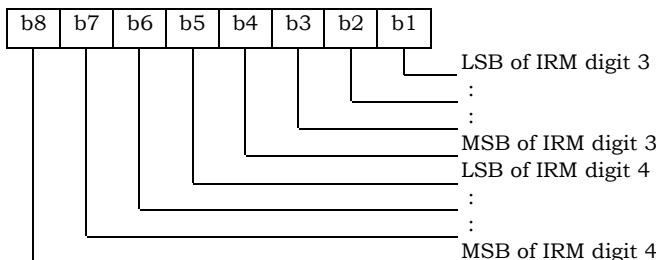

1

Byte 6:

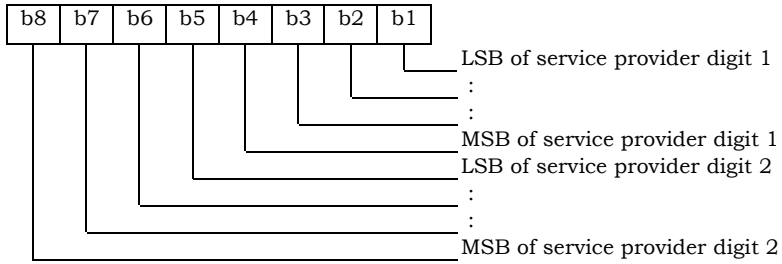

2

3

Byte 7:

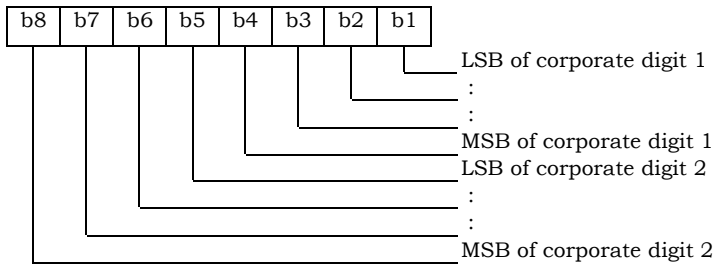

4

5

Empty fields shall be coded with 'FF'.

6

The end of the list is delimited by the first MCC field coded 'FFF'.

1 **5.2.75 EF<sub>HOME\_TAG</sub> (Home System Tag)**

2 This EF stores the Home System Tag, as described in Section 3.5.10.1 of [7].

3

Identifier: '6F70'		Structure: transparent		Mandatory
File size: X bytes		Update activity: low		
Access Conditions:				
READ		PIN		
UPDATE		ADM		
INVALIDATE		ADM		
REHABILITATE		ADM		
Bytes	Description	M/O	Length	
1 - X	Home System Tag (see Section 3.5.10.1 of [7])	M	Variable	

4  
5 This EF is stored using the convention from [7], i.e. fields are placed into octets starting with the  
6 MSB of the first field into bit 8 of the first octet, followed by the remaining fields placed in  
7 sequence into the remaining bits allocated for those fields. A multi-octet integer is stored by  
8 placing the octet with the MSB into the lowest numbered available octet allocated for that integer  
9 in the EF.

1 **5.2.76 EF<sub>GROUP\_TAG</sub> (Group Tag List)**

2 This EF stores the Group Tag List, as described in Section 3.5.10.3 of [7].

3

Identifier: '6F71'		Structure: transparent		Mandatory
File size: GROUP_TAG_LIST_SIZE		Update activity: low		
Access Conditions:				
READ	PIN			
UPDATE	ADM			
INVALIDATE	ADM			
REHABILITATE	ADM			
Bytes	Description	M/O	Length	
1-GROUP_TAG_LIST_SIZE	Group Tag List (see Section 3.5.10.3 of [7])	M	Variable	

4 This EF is stored using the convention from [7], i.e. fields are placed into octets starting with the  
5 MSB of the first field into bit 8 of the first octet, followed by the remaining fields placed in  
6 sequence into the remaining bits allocated for those fields. A multi-octet integer is stored by  
7 placing the octet with the MSB into the lowest numbered available octet allocated for that integer  
8 in the EF.

1 **5.2.77 EF<sub>SPECIFIC\_TAG</sub> (Specific Tag List)**

2 This EF stores the Specific Tag List, as described in Section 3.5.10.5 of [7].

3

Identifier: '6F72'		Structure: transparent		Mandatory
File size: SPEC_TAG_LIST_SIZE'		Update activity: low		
Access Conditions:				
READ	PIN			
UPDATE	ADM			
INVALIDATE	ADM			
REHABILITATE	ADM			
Bytes	Description	M/O	Length	
1-SPEC_TAG_LIST_SIZE	Specific Tag List (see Section 3.5.10.5 of [7])	M	Variable	

4

5 This EF is stored using the convention from [7], i.e. fields are placed into octets starting with the  
 6 MSB of the first field into bit 8 of the first octet, followed by the remaining fields placed in  
 7 sequence into the remaining bits allocated for those fields. A multi-octet integer is stored by  
 8 placing the octet with the MSB into the lowest numbered available octet allocated for that integer  
 9 in the EF.

1 **5.2.78 EF<sub>CALL\_PROMPT</sub> (Call Prompt List)**

2 This EF stores the Call Prompt List, as described in Section 3.5.10.7 of [7].

3

Identifier: '6F73'		Structure: transparent		Mandatory
File size: 'CALL_PRMPPT_LIST_SIZE'		Update activity: low		
Access Conditions:				
READ	PIN			
UPDATE	ADM			
INVALIDATE	ADM			
REHABILITATE	ADM			
Bytes	Description	M/O	Length	
1-CALL_PRMPPT_LIST_SIZE	Call Prompt List (see Section 3.5.10.7 of [7])	M	Variable	

4

5 This EF is stored using the convention from [7], i.e. fields are placed into octets starting with the  
6 MSB of the first field into bit 8 of the first octet, followed by the remaining fields placed in  
7 sequence into the remaining bits allocated for those fields. A multi-octet integer is stored by  
8 placing the octet with the MSB into the lowest numbered available octet allocated for that integer  
9 in the EF.

1 **5.2.79 EF<sub>SF\_EUIMID</sub> (Short Form EUIMID)**

2 If service n34 is available, this file shall be present.

3 This EF stores the 56-bit electronic identification number (ID) unique to the CSIM.

4 The order of the digits when treated as 14 four-bit digits is shown in the table below, with 'd1'  
 5 representing the leftmost/most significant digit and 'd14' representing the rightmost/least  
 6 significant digit.  
 7

Identifier: '6F74'		Structure: transparent				Optional				
File size: 7 bytes			Update activity: low							
Access Conditions:										
READ		ALW								
UPDATE		Never								
INVALIDATE		Never								
REHABILITATE		Never								
Description										
Bytes	8	7	6	5	4	3	2	1	M/O	Length
1	d13			d14				M	1 byte	
2	d11			d12				M	1 byte	
3	d9			d10				M	1 byte	
4	d7			d8				M	1 byte	
5	d5			d6				M	1 byte	
6	d3			d4				M	1 byte	
7	d1			d2				M	1 byte	

1 **5.2.80 EF<sub>EST</sub> (Enabled Service Table)**

2 If service n2 is “available” (as indicated in the CSIM Service Table), this file shall be present.

3 This EF indicates which services are enabled. If a service is not indicated as enabled in this table,  
4 the ME shall not select the service.

5

Identifier: '6F75'		Structure: transparent		Optional	
SFI: '0F'					
File size: X bytes			Update activity: low		
Access Conditions:					
READ		PIN			
UPDATE		PIN2			
DEACTIVATE		ADM			
ACTIVATE		ADM			
Bytes	Description			M/O	Length
1	Enabled Services n1 to n8			M	1 byte
2	Enabled Services n9 to n16			O	1 byte
etc.					
X	Enabled Services n (8X-7) to n(8X)			O	1 byte

6

Enabled Service number	Name	Corresponding CSIM Service number
1	Fixed Dialing Numbers (FDN)	2
2 – 8	Reserved	Not applicable

7

8 The EF shall contain at least one byte. Further bytes may be included, but if the EF includes an  
9 optional byte, then the EF shall also contain all bytes before that byte. Other services are possible  
10 in the future. The coding falls under the responsibility of the 3GPP2.

11 Coding:

- 12 - 1 bit is used to code each service:  
13 bit = 1: service enabled;  
14 bit = 0: service disabled.  
15 - Unused bits shall be set to '0'.

1 First byte:

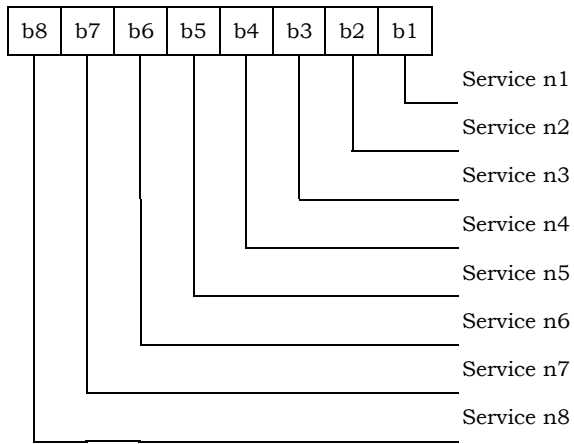

2

3 etc.

1 **5.2.81 EF<sub>HiddenKey</sub> (Key for hidden phone book entries)**

2 This EF contains the hidden key that has to be verified by the ME in order to display the phone  
3 book entries that are marked as hidden. The hidden key can consist of 4 to 8 digits.

4

Identifier: '6F76'		Structure: transparent		Optional	
File size: 4 bytes			Update activity: low		
Access Conditions:					
READ		PIN			
UPDATE		PIN			
DEACTIVATE		ADM			
ACTIVATE		ADM			
Bytes	Description			M/O	Length
1 to 4	Hidden Key			M	4 bytes

5

6 - Hidden Key.

7

Coding:

8

- The hidden key is coded on 4 bytes using BCD coding. The minimum number of digits is 4. Unused digits are padded with 'F'.

9

10

• NOTE 1: Digits are not swapped, i.e. for instance the key "1234" is coded as '12 34 FF FF'.

11

• NOTE 2: The phone book entries marked as hidden are not scrambled by means of the hidden key. They are stored in plain text in the phone book.

12

1 **5.2.82 EF<sub>LCSVER</sub> (LCS Protocol Version)**

2 If service n17 is available, this file shall be present.

3 This EF contains 'n' LCS Protocol Version Parameters (as defined in [50]) to indicate the version(s)  
4 of the supported protocol(s) supported by CSIM.

5 Each element of Protocol Version Parameter consists of 'S-SAFE Protocol version', 'TLS Session-A  
6 Protocol version', and 'TLS Session-B Protocol version'.

7 CSIM may support more than one version for each protocol.

8

Identifier: '6F77'		Structure: transparent		Optional	
File size: 4n bytes			Update activity: low		
Access Conditions:					
READ		PIN			
UPDATE		ADM			
DEACTIVATE		ADM			
ACTIVATE		ADM			
Bytes	Description			M/O	Length
1 to 4	1 <sup>st</sup> element of Protocol Version Parameter			M	4 bytes
...	...				..
4n-3 to 4n	n <sup>th</sup> element of Protocol Version Parameter			O	4 bytes

9

- 10 - Protocol Version Parameter

11 Contents:

12 S-SAFE Protocol version, TLS Session-A Protocol version, and TLS Session-B Protocol  
13 version.

14

15 Coding:

16 For each 4 bytes list element:

17 Byte 1: S-SAFE Protocol version (LCS\_S\_SAFE\_VERSION).

18 Byte 2 to 3: TLS Session-A Protocol version (TLS client\_version/server\_version).

19 Byte 4: TLS Session-B Protocol version (LCS\_UIM\_PDE\_TLS\_PSK\_VERSION).

20

21 Empty fields shall be coded with 'FF'.

1 **5.2.83 EF<sub>LCSCP</sub> (LCS Connectivity Parameter)**

2 If service n17 is available, this file shall be present.

3 This EF contains values for IP-based LCS Connectivity Parameters as determined by the issuer,  
4 which can be used by the ME for LCS network connection.

5

Identifier: '6F78'		Structure: Transparent		Optional	
File Size: X bytes			Update activity: low		
Access Conditions:					
READ		PIN			
UPDATE		ADM			
INVALIDATE		ADM			
REHABILITATE		ADM			
Bytes	Description			M/O	Length
1 to X	LCS TLS Connectivity Parameters TLV objects			M	X bytes

6

7

LCS TLS Connectivity Parameters tags

Description	Tag Value
H-PS address (IPv4) Tag	'80'
H-PS address (IPv6) Tag	'81'
H-PS address (URL) Tag	'82'

8

9

- LCS Connectivity Parameters contents

Description	Value	M/O	Length (bytes)
H-PS Address (IPv4) Tag	'80'	O	1
Length	6	O	1
H-PS IPv4 Address	--	O	4
H-PS IPv4 Port Number	--	O	2
H-PS Address (IPv6) Tag	'81'	O	1
Length	18	O	1
H-PS IPv6 Address	--	O	16
H-PS IPv6 Port Number	--	O	2
H-PS Address (URL) Tag	'82'	M	1
Length	X	M	1
H-PS URL Address	--	M	X

10

1 **5.2.84 EF<sub>SDN</sub> (Service Dialing Numbers)**

2 This EF contains special service numbers (SDN) and/or the respective supplementary service  
 3 control strings (SSC). In addition it contains identifiers of associated network/bearer capabilities  
 4 and identifiers of extension records at the CSIM ADF level. It may also contain associated  
 5 alpha-tagging.

6

Identifier: '6F79'		Structure: linear fixed		Optional	
Record length: X+14 bytes			Update activity: low		
Access Conditions:					
READ		PIN			
UPDATE		ADM			
DEACTIVATE		ADM			
ACTIVATE		ADM			
Bytes	Description	M/O	Length		
1-X	Alpha identifier	O	X bytes		
X+1	Length of BCD number/SSC contents	M	1 byte		
X+2	TON and NPI	M	1 byte		
X+3 to X+12	Dialing Number/SSC String	M	10 bytes		
X+13	Reserved ('FF')	M	1 byte		
X+14	Extension3 (EF <sub>EXT3</sub> ) Record Identifier	M	1 byte		

7

8 For contents and coding of all data items see the respective data items of the EF<sub>ADN</sub> (Section  
 9 5.4.1), with the exception that extension records are stored in the EF<sub>EXT3</sub>.

10 NOTE: The value of X (the number of bytes in the alpha-identifier) may be different from the  
 11 length denoted X in EF<sub>ADN</sub>.

12

1 **5.2.85 EF<sub>EXT2</sub>(Extension2)**

2 This EF contains extension data of an FDN (see FDN in 5.2.27).

3

Identifier: '6F7A'		Structure: linear fixed		Optional	
Record length: 13 bytes			Update activity: low		
Access Conditions:					
READ		PIN			
UPDATE		PIN2			
DEACTIVATE		ADM			
ACTIVATE		ADM			
Bytes	Description	M/O	Length		
1	Record type	M	1 byte		
2 to 12	Extension data	M	11 bytes		
13	Identifier	M	1 byte		

4

5 For contents and coding see Section 5.4.2 (EF<sub>EXT1</sub>).

1 **5.2.86 EF<sub>EXT3</sub>(Extension3)**

2 This EF contains extension data of an SDN (see SDN in 5.2.81).

3

Identifier: '6F7B'		Structure: linear fixed		Optional	
Record length: 13 bytes			Update activity: low		
Access Conditions:					
READ		PIN			
UPDATE		ADM			
DEACTIVATE		ADM			
ACTIVATE		ADM			
Bytes	Description	M/O	Length		
1	Record type	M	1 byte		
2 to 12	Extension data	M	11 bytes		
13	Identifier	M	1 byte		

4

5 For contents and coding see Section 5.4.2 (EF<sub>EXT1</sub>).

## 1 **5.2.87 EF<sub>ICI</sub> (Incoming Call Information)**

2 If service n28 is "available", this file shall be present.

3 This EF is located within the CSIM application. The incoming call information can be linked to the  
4 phone book stored under DF<sub>TELECOM</sub> or to the local phone book within the CSIM. The EF<sub>ICI</sub>  
5 contains the information related to incoming calls.

6 The time of the call and duration of the call are stored in this EF. This EF can also contain  
7 associated alpha identifier that may be supplied with the incoming call. In addition, it contains  
8 identifiers of associated network/bearer capabilities and identifiers of extension records at the  
9 CSIM ADF level. The structure of this EF is cyclic, so the contents shall be updated only after a  
10 call is disconnected.

11 If Calling Line Identifier is supported and the incoming phone number matches a number stored  
12 in the phone book the incoming call information is linked to the corresponding information in the  
13 phone book. If the incoming call matches an entry but is indicated as hidden in the phone book  
14 the link is established but the information is not displayed by the ME if the code for the secret  
15 entry has not been verified. The ME shall not ask for the secret code to be entered at this point.

16 Optionally the ME may store the link to phone book entry in the file, so that it does not need to  
17 look again for a match in the phone book when it reuses the entry. But the ME will have to check  
18 that the incoming call number still exists in the linked phone book entry, as the link might be  
19 broken (entry modified). When not used by the ME or no link to the phone book has been found,  
20 this field shall be set to 'FFFFFF'.

21 The first byte of this link is used to identify clearly the phone book location either global (i.e.  
22 under DF<sub>TELECOM</sub>) or local (i.e. CSIM specific).

23 For the current version of the phone book, the phone book entry is identified as follows:

- 24 - the record number in the EF<sub>PBR</sub> which indicates the EF<sub>ADN</sub> containing the entry;
- 25 - the record number inside the indicated EF<sub>ADN</sub>.

1 The structure of EF<sub>ICI</sub> is shown below. Coding scheme is according to EF<sub>ADN</sub>

2

Identifier: '6F7C'		Structure: Cyclic		Optional	
SFI: '10'					
Record length: X+28 bytes			Update activity: high		
Access Conditions:					
READ		PIN			
UPDATE		PIN			
DEACTIVATE		ADM			
ACTIVATE		ADM			
Bytes	Description	M/O	Length		
1 to X	Alpha Identifier	O	X bytes		
X+1	Length of BCD number contents	M	1 byte		
X+2	TON and NPI	M	1 byte		
X+3 to X+12	Incoming Call Number	M	10 bytes		
X+13	Reserved ('FF')	M	1 byte		
X+14	Extension5 (EF <sub>EXT5</sub> ) Record Identifier	M	1 byte		
X+15 to X+21	Incoming call date and time (see detail 1)	M	7 bytes		
X+22 to X+24	Incoming call duration (see detail 2)	M	3 bytes		
X+25	Incoming call status (see detail 3)	M	1 byte		
X+26 to X+28	Link to phone book entry (see detail 4)	M	3 bytes		

3

4 NOTE: When the contents except incoming call status are invalid, they are filled with 'FF'.

1 **Detail 1: Coding of date and time.**

2 Content:  
 3 the date and time are defined by the ME.

4 Coding:  
 5 it is according to the extended BCD coding from Byte1 to Byte 7. The first 3 bytes show year,  
 6 month and day (yy.mm.dd). The next 3 bytes show hour, minute and second (hh.mm.ss).  
 7 The last Byte 7 is Time Zone. The Time Zone indicates the difference, expressed in quarters  
 8 of an hour, between the local time and GMT. Bit 4 in Byte 7 represents the algebraic sign of  
 9 this difference (0: positive, 1: negative). If the terminal does not support the Time Zone, Byte  
 10 7 shall be "FF". Byte X+15: Year.

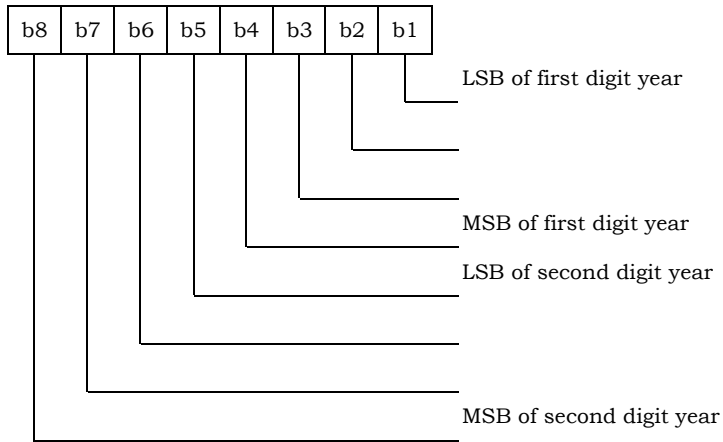

11

12 Byte X+16: Month

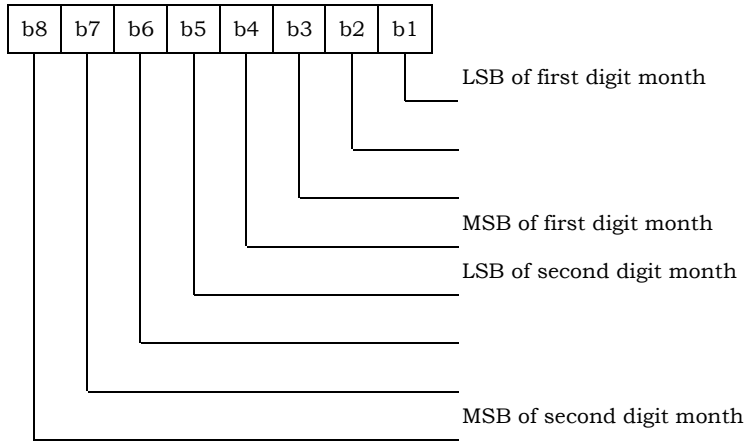

13

1 Byte X+17: Day

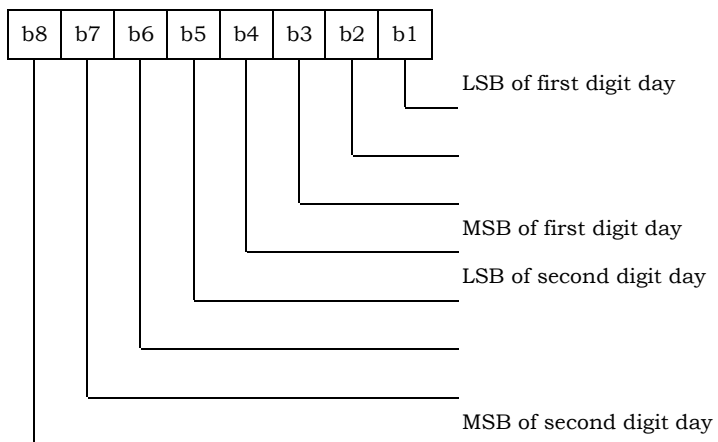

2

3 Byte X+18: Hour

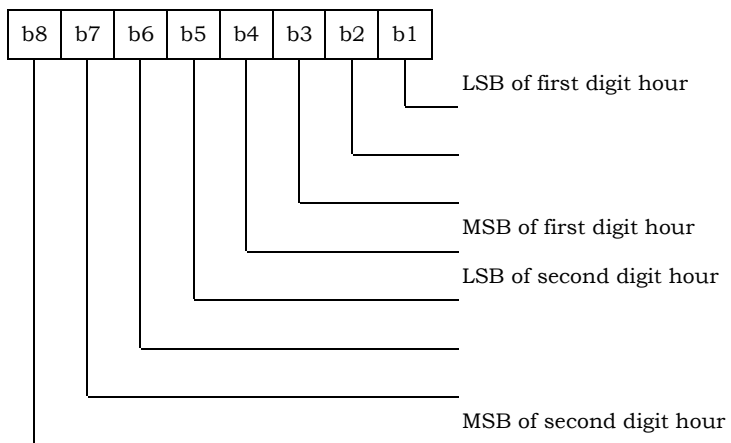

4

5 Byte X+19: Minute

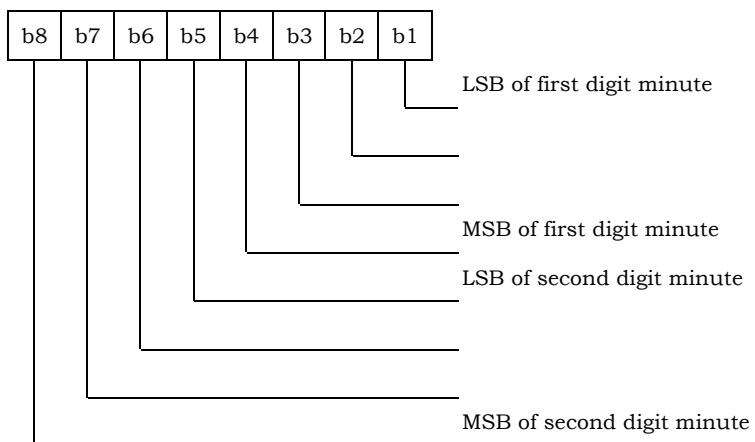

6

1 Byte X+20: Second

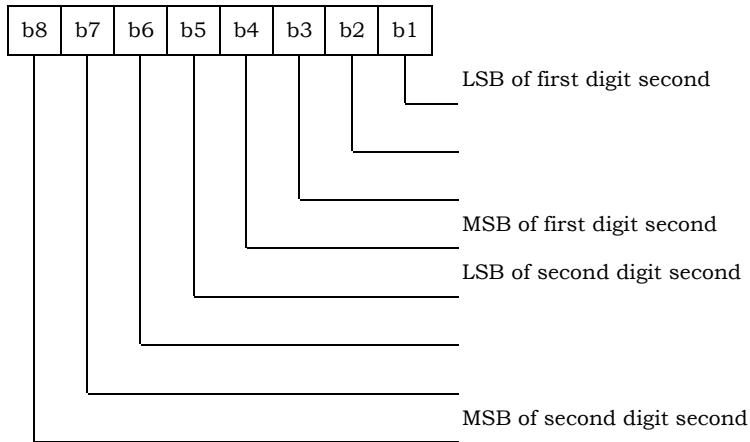

2

3 Byte X+21: Time Zone

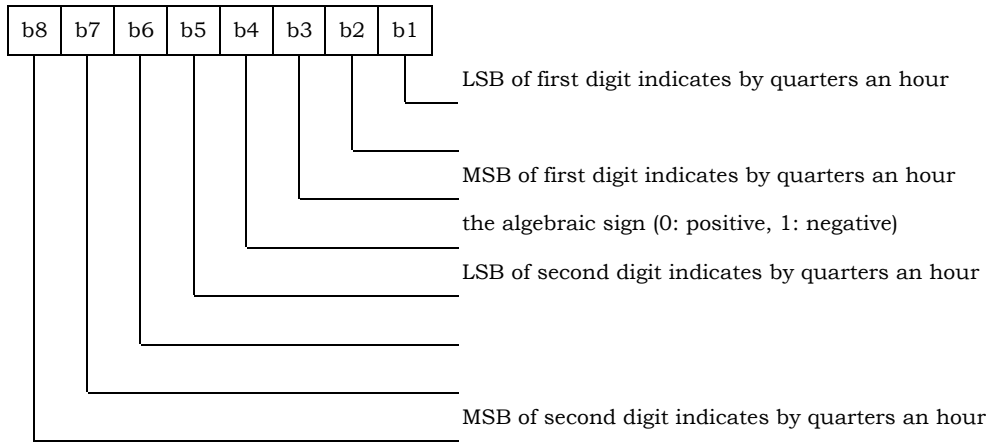

4

5 **Detail 2: Coding of call duration.**

6 Call duration is indicated by second.

7 Byte X+22:

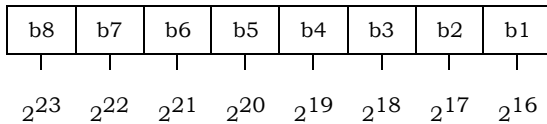

8

9 Byte X+23:

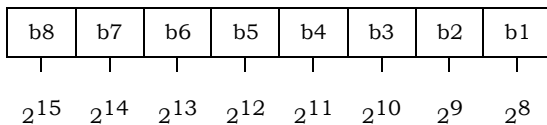

10

1 Byte X+24:

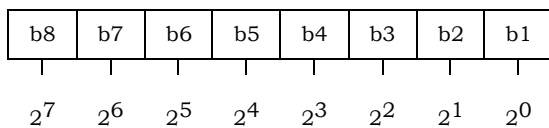

2 For instance, '00' '00' '30' represents 2<sup>5</sup>+2<sup>4</sup>.

3

4 **Detail 3: Coding of Call status.**

5 Byte X+25:

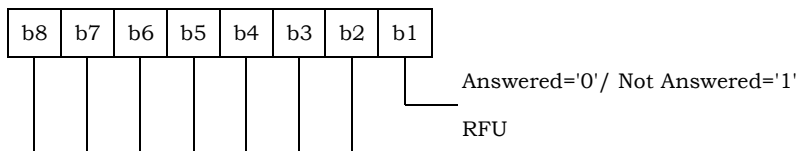

6

7 **Detail 4: Link to phone book entry**

8 For the current implementation of the phone book the following coding applies:

9 Phone book reference.

10 Byte X+26:

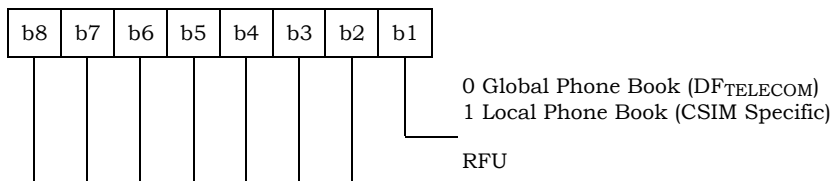

11

12 EF<sub>PBR</sub> record number:

13 Byte X+27: Hexadecimal value.

14 EF<sub>ADN</sub> record number:

15 Byte X+28: Hexadecimal value.

## 5.2.88 EF<sub>OCI</sub> (Outgoing Call Information)

If service n27 is "available", this file shall be present.

The outgoing call information can be linked to the phone book stored under DF<sub>TELECOM</sub> or to the local phone book within the CSIM. The EF<sub>OCI</sub> contains the information related to outgoing calls.

The time of the call and duration of the call are stored in this EF. It may also contain associated alpha identifier. In addition it contains identifiers of associated network/bearer capabilities and identifiers of extension records at the CSIM ADF level. The structure of this file is cyclic, so the contents shall be updated only after a call is disconnected.

If the dialed phone number matches a number stored in the phone book the outgoing call information might be linked to the corresponding information in the phone book. The dialed number may match with a hidden entry in the phone book. If the dialed number matches a hidden entry in the phone book the link is established but the information related to the phone book entry is not displayed by the ME, if the hidden code has not been verified. The ME shall not perform hidden code verification at this point.

Optionally, the ME may store the link to phone book entry in the file, so that it does not need to look again for a match in the phone book when it reuses the entry. But the ME will have to check that the outgoing call number still exists in the linked phone book entry, as the link might be broken (entry modified). When not used by the ME or no link to the phone book has been found, this field shall be set to 'FFFFFF'.

Coding scheme is according to EF<sub>ICI</sub>.

Identifier: '6F7D'		Structure: Cyclic		Optional	
SFI: '11'					
Record length: X+27 bytes			Update activity: high		
Access Conditions:					
READ		PIN			
UPDATE		PIN			
DEACTIVATE		ADM			
ACTIVATE		ADM			
Bytes	Description			M/ O	Length
1 to X	Alpha Identifier			O	X bytes
X+1	Length of BCD number/SSC contents			M	1 byte
X+2	TON and NPI			M	1 byte
X+3 to X+12	Outgoing Call Number/SSC String			M	10 bytes
X+13	Reserved ('FF')			M	1 byte

X+14	Extension5 (EF <sub>EXT5</sub> ) Record Identifier	M	1 byte
X+15 to X+21	Outgoing call date and time	M	7 bytes
X+22 to X+24	Outgoing call duration	M	3 bytes
X+25 to X+27	Link to Phone Book Entry	M	3 bytes

1

2

NOTE: When the contents are invalid, they are filled with 'FF'.

1 **5.2.89 EF<sub>EXT5</sub> (Extension 5)**

2 This EF contains extension data of EF<sub>IC1</sub> and EF<sub>OC1</sub> of the CSIM application.

3

Identifier: '6F7E'		Structure: linear fixed		Optional	
Record length: 13 bytes			Update activity: low		
Access Conditions:					
READ		PIN			
UPDATE		PIN			
DEACTIVATE		ADM			
ACTIVATE		ADM			
Bytes	Description	M/O	Length		
1	Record type	M	1 byte		
2 to 12	Extension data	M	11 bytes		
13	Identifier	M	1 byte		

4

5 For contents and coding see Section 5.4.2 (EF<sub>EXT1</sub>).

1 **5.2.90 EF<sub>CCP2</sub> (Capability Configuration Parameters 2)**

2 This EF contains no valid information.

3

Identifier: '6F7F'		Structure: linear fixed		Optional	
SFI: '12'					
Record length: X bytes, X≥15			Update activity: low		
Access Conditions: READ            PIN UPDATE        PIN DEACTIVATE    ADM ACTIVATE       ADM					
Bytes	Description			M/O	Length
1 to X	Reserved (fill with 'FF')			M	X bytes

1 **5.2.91 Reserved**

1 **5.2.92 EF<sub>AppLabels</sub> (Application Labels)**

2 This EF contains text labels that shall be associated with the icons or menu items used to launch  
 3 applications. Use of these labels is optional and need only be provisioned if an operator desires to  
 4 override the ME-defined labels.

5

Identifier: '6F80'		Structure: Transparent		Optional
File size: 4+N*32			Update Activity: Low	
Access Conditions:				
READ		PIN		
UPDATE		ADM		
INVALIDATE		ADM		
REHABILITATE		ADM		
Bytes	Description	M/O	Length	
1	Character Encoding	M	1 byte	
2	Language Indicator	M	1 byte	
3 – 4	Application Labels Present	M	2 bytes	
5 – 36	Application Label <sub>1</sub>	O	32 bytes	
37 – 68	Application Label <sub>2</sub>	O	32 bytes	
...	...	O	...	
5+(N-1)*32 to 36+(N-1)*32	Application Label <sub>N</sub>	O	32 bytes	

6

7 - Character Encoding:

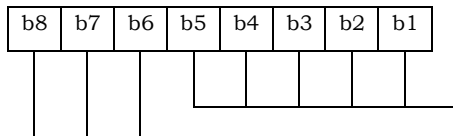

CHARi encoding type per Table 9.1-1, Data Field Encoding Assignments, of [Informative 1]  
 RFU

8

9 - Language Indicator:

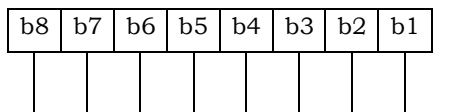

Language Indicator per Table 9.2-1, Language Indicator Value Assignments of [Informative 1]

1 - Application Labels Present:

2 This field is a bitmask used to identify which Application Label Fields are present in the EF.  
3 Each bit represents a particular application as shown below:

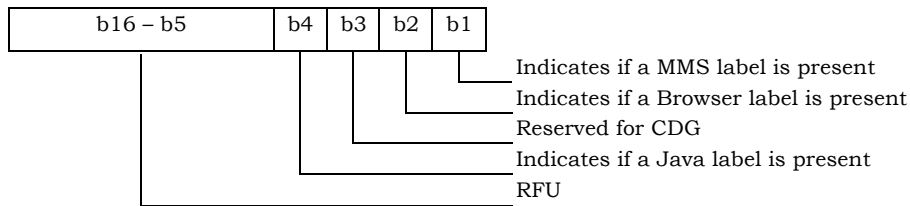

4

5 If a bit is set to '1,' an Application Label Field for that application shall be present. If the bit is  
6 set to '0,' an Application Label Field for that application shall not be present and the ME user  
7 interface will display the generic label for that application.

8 - Application Label:

9 Each Application Label field contains the text label to be displayed with the icon or menu item  
10 used to launch that application. The Application Label Present field identifies which Application  
11 Label fields are present in the EF. These Application Label fields shall be present in the same  
12 order as their corresponding bits in the Application Labels Present field. The string contents of  
13 each Application Label field shall use the SMS convention as defined in Tables 9.1-1 and 9.2-1  
14 of [Informative 1]. The string shall be left justified. Unused bytes shall be set to 'FF.'

15

16 If the string is coded as 7-bit, the SMS default 7 bit coded alphabet as referenced in  
17 [Informative 1] with bit 8 set to 0 shall be used.

1 **5.2.93 EF<sub>Model</sub> (Device Model Information)**

2 This EF contains the model information of the ME. Similar to EF<sub>ESN\_MEID\_ME</sub>, this EF is populated  
 3 by the device during power-up. This EF enables CCAT applications to provide model information  
 4 to the network either automatically or on demand.

5

Identifier: '6F81'		Structure: Transparent		Optional	
File Size: 126			Update activity: Low		
Access Conditions:					
READ		PIN			
UPDATE		PIN			
INVALIDATE		ADM			
REHABILITATE		ADM			
Bytes	Description	M/O	Length		
1	Character Encoding	M	1 byte		
2	Language Indicator	M	1 byte		
3-34	Model Information	M	32 bytes		
35-66	Manufacturer Name	M	32 bytes		
67-126	Software Version Information	M	60 ytes		

6

7 - Character Encoding:

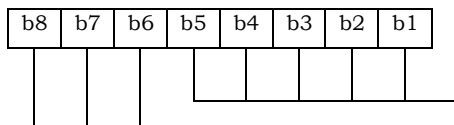

CHARi encoding type per Table 9.1-1, Data Field Encoding Assignments, of [Informative 1]  
RFU

8

9 - Language Indicator:

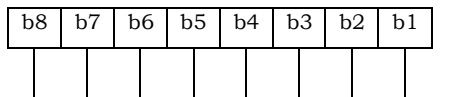

Language Indicator per Table 9.2-1, Language Indicator Value Assignments, of [Informative 1]

10

11 - Model Information:

12 This field is a string indicating the model name of the device (e.g., "ABCCOM-XYZ"). The string  
 13 contents shall use the SMS convention as defined in Tables 9.1-1 and 9.2-1 of [Informative 1].  
 14 The string shall be left justified. Unused bytes shall be set to 'FF.'

15

16 - Manufacturer Name:

17 This field is a string indicating the manufacturer of the device. The string contents shall use  
 18 the SMS convention as defined in Tables 9.1-1 and 9.2-1 of [Informative 1]. The string shall be  
 19 left justified. Unused bytes shall be set to 'FF.'

1  
2  
3  
4  
5

## - Software Version Information:

This field is a string indicating the software version of the device (e.g., “6.0 patch 01”). The string contents shall use the SMS convention as defined in Tables 9.1-1 and 9.2-1 of [Informative 1]. The string shall be left justified. Unused bytes shall be set to ‘FF.’

6  
7  
8  
9  
10**5.2.94 EF<sub>RC</sub> (Root Certificates)**

If service n36 (Root Certificates) is allocated, this EF shall be present.

This EF contains the root certificates for applications on the device. One or more applications are associated with each certificate.

Identifier: ‘6F82’		Structure: Transparent		Optional	
File Size: $X_1+\dots+X_n$			Update activity: Low		
Access Conditions:					
READ		ALW			
UPDATE		ADM			
INVALIDATE		ADM			
REHABILITATE		ADM			
Bytes	Description		M/O	Length	
1 to $X_1$	Certificate TLV Object		M	$X_1$ bytes	
$X_1+1$ to $X_1+X_2$	Certificate TLV Object		O	$X_2$ bytes	
...	...		O	...	
$X_1+\dots+X_{n-1}+1$ to $X_1+\dots+X_n$	Certificate TLV Object		O	$X_n$ bytes	

11  
12

Unused bytes shall be set to ‘FF.’ A Tag value of ‘FF’ indicates the end of valid data.

1 - Certificate TLV Object – Contents:

Description	Value	M/O	Length
Certificate Tag	'80'	M	1 byte
Length	Note 1	M	Note 2
Certificate Type	Note 3	M	1 byte
Certificate Information	Note 4	M	Variable
Applications	Note 3	M	2 bytes
<p>NOTE 1: This is the total size of the constructed TLV object (not including the tag and this length).</p> <p>NOTE 2: The length is coded according to [60] using primitive encoding and the minimum number of octets.</p> <p>NOTE 3: See coding below.</p> <p>NOTE 4: Binary data for the certificate information as defined in corresponding Certificate Type as defined below, e.g., X.509.</p>			

2

3 - Certificate Type – Coding:

Value	Name	Notes
0	DER Encoded Binary X.509	See section 7 “Public-keys and public-key certificates” in [59] for the definition. The binary encoding is per DER encoding defined in [60].
1	Base64 Encoded X.509	See section 7 “Public-keys and public-key certificates” in [59]. The encoding is per DER encoding defined in [60] and the DER binary data is converted to Base 64 text format.
2	PKCS #7	See section 6.5 “ExtendedCertificateOrCertificate” in [61] for the definition. The binary encoding is per DER encoding defined in [60].
3	PKCS #12	See section 4.2.3 “The CertBag type” in [62] for the definition. The binary encoding is per DER encoding defined in [60].
4-255	Reserved for future use	

4

## 1 - APPLICATIONS:

2 This field is a bitmask used to indicate which applications are associated with a particular  
 3 certificate. If the same certificate is being used for all applications signed by the operator, only  
 4 bit 1 (Unspecified) will be set. Otherwise, if the operator signs different applications using  
 5 different certificates, the bit for each application associated with the certificate shall be set.  
 6 Note that, while each certificate may be associated with multiple applications, each application  
 7 may only be associated with one certificate.

Bit	Application
1	Unspecified (all applications use the same profile)
2	Reserved
3	WAP Browser
4	Reserved for CDG
5	Java
6	Reserved for CDG
7	Terminal (tethered mode for terminal access)
8-16	Reserved for future use

8

1 **5.2.95 EF<sub>SMSCAP</sub> (SMS Capabilities)**

2 If services n6 (Short Message Storage) and n35 (Messaging and 3GPD Extensions) are allocated,  
 3 this EF shall be present.

4 This EF contains information about SMS Capabilities.

5

Identifier: '6F83'		Structure: Transparent		Optional
File size: 4 bytes			Update Activity: Low	
Access Conditions:				
READ		PIN		
UPDATE		ADM		
INVALIDATE		ADM		
REHABILITATE		ADM		
Bytes	Description	M/O	Length	
1	SMS Retry Period	M	1 byte	
2	SMS Retry Interval	M	1 byte	
3	SMS Flags	M	1 byte	
4	SMS Preferred Service Option	M	1 byte	

6

7 - SMS Retry Period:

8 This is the overall time period (in seconds) during which the Mobile Originated (MO) SMS  
 9 retries can be performed. 0 means that MO SMS retry is disabled.

10 - SMS Retry Interval:

11 This is the time interval (in seconds) that the device shall wait before the next retry attempt  
 12 can be made after a MO SMS failure.

13 - SMS Flags:

14 0 – disabled; 1 – enabled

Bit	Parameter Indicated
1	Send On Access (Allow MO SMS to be sent over Access Channel)
2	Send On Traffic (Allow MO SMS to be sent over Traffic Channel)
3	Send as Standard EMS (Network supports standard EMS per [8])
4-8	RFU

## 1 - SMS Preferred Service Option:

2 This is the preferred service option to be used when the device sets up SMS traffic channel for  
3 sending messages.

<b>Value</b>	<b>Description</b>
0	Device Default
1	Service Option 6
2	Service Option 14
3-255	Reserved for future use

1 **5.2.96 EF<sub>MIPFlags</sub> (Mobile IP Flags)**

2 If services n15 (3GPD-MIP) and n35 (Messaging and 3GPD Extensions) are allocated, this EF shall  
 3 be present.

4 This EF contains the configuration flags for Mobile IP.

5

Identifier: '6F84'		Structure: Transparent		Optional	
File size: 1 byte			Update Activity: Low		
Access Conditions:					
READ		PIN			
UPDATE		ADM			
INVALIDATE		ADM			
REHABILITATE		ADM			
Bytes	Description			M/O	Length
1	MIP_FLAGS			M	1 byte

6

7 - MIP\_FLAGS:

8 0 – disabled; 1 – enabled

Bit	Parameter Indicated
1	Mobile IP MN HA Authentication. When this bit is enabled MN HA Authentication should be according to [23]. When this bit is disabled MN HA Authentication should be according to [75].
2	Mobile IP Pre Rev 6 handoff optimization
3	Mobile IP PPP Re-sync during hand-down from 1xEV-DO Rev 0 to 1x
4	Mobile IP Re-registration only if data has been transferred since last registration in order to extend Mobile IP address lifetime
5-8	RFU

9

1 **5.2.97 EF<sub>3GPDUPPExt</sub> (3GPD User Profile Parameters Extension)**

2 If service n14 (3GPD-SIP) or n15 (3GPD-MIP) is allocated and service n35 (Messaging and 3GPD  
3 Extensions) is allocated, this EF shall be present.

4 This EF contains additional parameters for Simple IP and Mobile IP User Profiles in order to fully  
5 support the feature of multiple profiles.  
6

Identifier: '6F85'		Structure: Transparent		Optional
File size: X bytes			Update Activity: Low	
Access Conditions:				
READ		PIN		
UPDATE		ADM		
INVALIDATE		ADM		
REHABILITATE		ADM		
Bytes	Description	M/O	Length	
X	UPP Extension Block	M	X bytes	

7  
8 Unused bytes shall be set to 'FF.'

9 - UPP Extension Block structure:

Field	Length (bits)
NUM_NAI	4

*NUM\_NAI occurrences of the following fields:*

NAI_ENTRY_INDEX	4
APPLICATIONS	32
PRIORITY	8
DATA_RATE_MODE	4
DATA_BEARER	4

RESERVED	0 or 4
----------	--------

10  
11 - NUM\_NAI:

12 Number of UPP Extension instances. This number shall be the same as NUM\_NAI in the base  
13 user profile EF (EF<sub>SIPUPP</sub> or EF<sub>MIPUPP</sub>).

## 1 - NAI\_ENTRY\_INDEX:

2 Index to the list of UPP Extension instances. This index shall point to the UPP Extension  
3 instance that is corresponding to the base UPP instance with the same index value as defined  
4 in EF<sub>SIPUPP</sub> or EF<sub>MIPUPP</sub>.

## 5 - APPLICATIONS:

6 This field is a bitmask used to indicate which applications are associated with a particular  
7 profile. The applications shall use the profile having the “Unspecified” bit set in the  
8 APPLICATIONS bitmask if they are not present in any other profiles.

Bit	Application
1	Unspecified ( <i>used by applications not present in any other profile</i> )
2	MMS
3	WAP Browser
4	Reserved for CDG
5	Java
6	Reserved for CDG
7	Terminal ( <i>tethered mode for terminal access</i> )
8	Operator Administration (e.g. BIP)
9-32	Reserved for future use

## 9 - PRIORITY:

10 When attempting to launch a new application, it is possible that another application is already  
11 active and has already established a data session. If the new application has the same  
12 PRIORITY value as the previous application that established the existing data session, the new  
13 application may simply reuse the existing data session.

14 If the new application has a different PRIORITY than the previous application that set up the  
15 existing data session, the device may use the PRIORITY to determine which application has  
16 higher priority, as follows:

Value	Priority
0	Highest priority category
1	Second highest priority category (lower than 0; higher than 2 and others)
2	Third highest priority category (lower than 0 or 1; higher than 3 and others)
:	:
255	Lowest priority

## 17 - DATA\_RATE\_MODE:

18 Data Rate Mode

Value	Application
0	Low Speed: Low speed service options only
1	Medium Speed: F-SCH with service option 33 only
2	High Speed: F-SCH and R-SCH with service option 33
3-15	Reserved for future use

1 - DATA\_BEARER:

2 Data Bearer

3

<b>Value</b>	<b>Application</b>
0	Hybrid 1x/1xEV-DO
1	1x only
2	1xEV-DO only
3-15	Reserved for future use

1 **5.2.98 Reserved**

2

1 **5.2.99 EF<sub>IPv6CAP</sub> (IPv6 Capabilities)**

2 If services n35 (Messaging and 3GPD Extensions) and n41 (IPv6) are allocated, this EF shall be  
3 present.

4 This EF contains information about IPv6 capabilities.

5

Identifier: '6F87'		Structure: Transparent		Optional
File size: 21 bytes			Update Activity: Low	
Access Conditions:				
READ		PIN		
UPDATE		ADM		
INVALIDATE		ADM		
REHABILITATE		ADM		
Bytes	Description	M/O	Length	
1-2	Initial neighbor solicitation delay time	M	2 bytes	
3-4	Solicitation interval	M	2 bytes	
5-6	Re-solicitation interval	M	2 bytes	
7-8	Maximum solicitation attempts	M	2 bytes	
9-10	Maximum re-solicitation attempts	M	2 bytes	
11-12	Pre-RA expiry re-solicitation time	M	2 bytes	
13-20	IID Information	M	8 bytes	
21	IPv6 Flags	M	1 byte	

6

- 7 • **Initial neighbor solicitation delay time** (*in units of 100ms*): Time MS waits after the IID  
8 (Interface ID) has been negotiated before sending an RS (Router Solicitation) in an attempt to  
9 receive an RA (Router Advertisement).

1       **Coding:** 16-bit integer.

2       Byte 1:

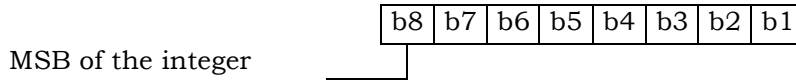

3       Byte 2:

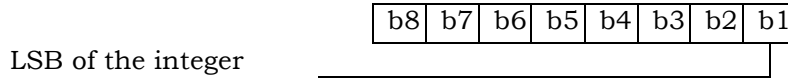

4

- 5       • **Solicitation interval** (*in units of 100ms*): Amount of time the MS waits before sending a
- 6       subsequent RS after a previous one.

7       **Coding:** 16-bit integer.

8       Byte 1:

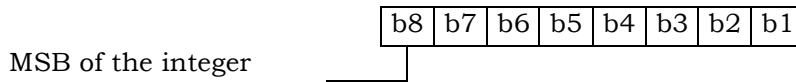

9       Byte 2:

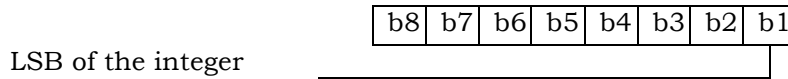

10

- 11       • **Re-solicitation interval** (*in units of 100ms*): Amount of time between solicitations sent while re-
- 12       soliciting for a new RA. This interval applies only after the MS has previously received one
- 13       valid RA and is soliciting for a new one to renew the lifetimes of the current prefix or retrieve a
- 14       non-deprecated prefix.

15       **Coding:** 16-bit integer.

16       Byte 1:

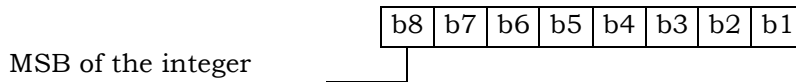

17       Byte 2:

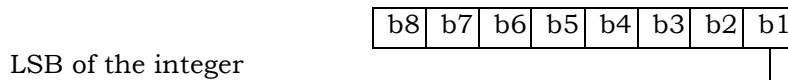

18

- 1 • **Max solicitation attempts:** Number of solicitation attempts to make for initial IPv6 session  
 2 establishment, when an RA is not received in response before giving up IPv6 auto-  
 3 configuration.

4 **Coding:** 16-bit integer.

5 Byte 1:

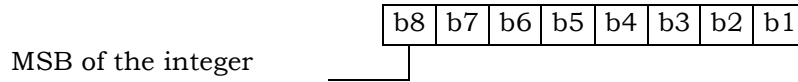

6 Byte 2:

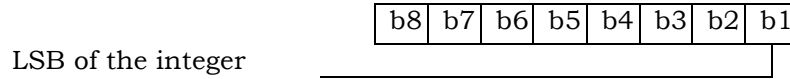

- 7  
 8 • **Max re-solicitation attempts:** Number of solicitation attempts to make to re-solicit for a new  
 9 RA.

10 **Coding:** 16-bit integer.

11 Byte 1:

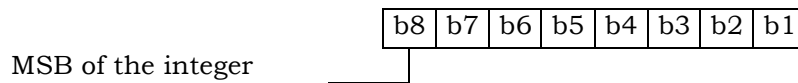

12 Byte 2:

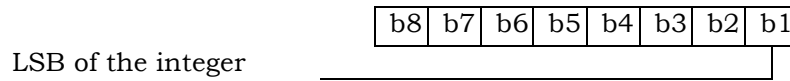

- 13  
 14 • **Pre-RA expiry re-solicitation time** (*in units of 100ms*): Amount of time before the current RA  
 15 expires to begin re-solicitations.

16 **Coding:** 16-bit integer.

17 Byte 1:

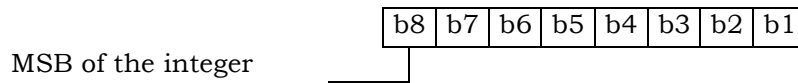

18 Byte 2:

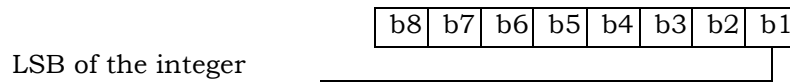

- 19  
 20 • **IID Information:** IID is part of the IPv6 address. See [63] for information on coding.

- 1
- **IPv6 Flags:** Identify IPv6 behavior. Coding (0 – Disabled; 1 – Enabled).

Bit	Parameter Indicated
1	Use IPv6
2	Failover from IPv6 to IPv4
3	PDSN as proxy IPv6 DNS server. When enabled, the MS forwards all DNS requests to the PDSN. The PDSN forwards requests to the appropriate DNS server. This parameter is meaningful only if the primary and secondary DNS server addresses are not available.
4-8	RFU

2

1 **5.2.100 EF<sub>TCPConfig</sub> (TCP Configurations)**

2 If service n14 (3GPD-SIP) or n15 (3GPD-MIP) is allocated and service n35 (Messaging and 3GPD  
3 Extensions) is allocated, this EF shall be present.

4 This EF contains information about Transmission Control Protocol configurations.

5

Identifier: '6F88'		Structure: Transparent		Optional
File size: 2 bytes			Update Activity: Medium	
Access Conditions:				
READ		PIN		
UPDATE		ADM		
INVALIDATE		ADM		
REHABILITATE		ADM		
Bytes	Description	M/O	Length	
1	TCP Flags	M	1 byte	
2	TCP Keep-Alive Idle Timer	M	1 byte	

6

- 7 • **TCP Flags:** Coding (0 – Disabled; 1 – Enabled):

Bit	Parameter Indicated
1	TCP Graceful close of dormant connections
2-8	RFU

8

- 9 • **TCP Keep-Alive Idle Timer:** Coding: Number of minutes. A value of 0 means that the TCP  
10 keep-alive feature is disabled on the ME.

11

1 **5.2.101 EF<sub>DGC</sub> (Data Generic Configurations)**

2 If service n14 (3GPD-SIP) or n15 (3GPD-MIP) is allocated and service n35 (Messaging and 3GPD  
3 Extensions) is allocated, this EF shall be present.

4 This EF contains miscellaneous data configuration items.

5

Identifier: '6F89'		Structure: Transparent		Optional
File size: 3 bytes			Update Activity: Medium	
Access Conditions:				
READ		PIN		
UPDATE		ADM		
INVALIDATE		ADM		
REHABILITATE		ADM		
Bytes	Description	M/O	Length	
1	Data dormant timer	M	1 byte	
2	EPZID Type Information	M	1 byte	
3	Hysteresis Activation Time	M	1 byte	

6

7 • **Data dormant timer:** Number of seconds to wait before going into data dormant mode, which  
8 shall be at least 20 seconds.

9 • **EPZID Type Information:** Contains the Extended Packet Zone ID Types.

Value	Description
0	Packet Zone ID
1	Packet Zone ID plus SID
2	Packet Zone ID plus SID and NID
3-255	Reserved for future use

10

11 • **Hysteresis Activation Time:** This is the number of seconds that the device should wait before  
12 it goes into hysteresis state and adds new Packet Zone IDs to the packet zone list as needed.  
13 See [65] for details on usage of this timer.

14

### 5.2.102 EF<sub>WAPBrowserCP</sub> (WAP Browser Connectivity Parameters)

If service n37 (WAP Browser) is allocated, this EF shall be present.

This EF contains the connectivity parameters for a WAP Browser application, such as Gateway and Home URL information. At least one gateway shall be configured in this EF as the primary gateway for browsing. Additional gateways as part of the additional instances of Connectivity Parameters can be optionally configured as secondary gateways in the order of priority as they appear in this EF.

Identifier: '6F8A'		Structure: Transparent		Optional	
File Size: $X_1 + \dots + X_n$			Update activity: Low		
Access Conditions:					
READ		PIN			
UPDATE		ADM			
INVALIDATE		ADM			
REHABILITATE		ADM			
Bytes	Description	M/O	Length		
1 to $X_1$	WAP Browser Connectivity Parameters TLV object	M	$X_1$ bytes		
$X_1+1$ to $X_1 + X_2$	WAP Browser Connectivity Parameters TLV object	O	$X_2$ bytes		
...	...				
$X_1 + \dots + X_{n-1} + 1$ to $X_1 + \dots + X_n$	WAP Browser Connectivity Parameters TLV object	O	$X_n$ bytes		

Unused bytes shall be set to 'FF.' A Tag value of 'FF' indicates the end of valid data.

- WAP Browser Connectivity Parameters Tags:**

Description	Tag Value
WAP Browser Connectivity Parameters Tag	'AC'
Gateway Tag	'83'
HomeURL Tag	'80'

1 • **WAP Browser Connectivity Parameters TLV Object contents:**

Description	Value	M/O	Length (bytes)
WAP Browser Connectivity Parameters Tag	'AC'	M	1
Length	Note 1	M	Note 2
Gateway Tag	'83'	O	1
Gateway Length	Z	O	Note 2
Gateway Information	--	O	Z
HomeURL Tag	'80'	M	1
HomeURL Length	X	M	Note 2
HomeURL Information	--	M	X
NOTE 1: This is the total size of the constructed TLV object (not including the tag and this length).			
NOTE 2: The length is coded according to [60] using primitive encoding and the minimum number of octets.			

2

3 • **Gateway Tag:** This contains information needed to access the WAP Gateway/Proxy server. See  
4 description of EF<sub>MMSICP</sub> for the definition of Gateway TLV Object.

5 • **HomeURL Tag:** This contains the URL for the WAP Browser's home page for the current  
6 particular connectivity parameters. For contents and syntax of URL TLV data object values,  
7 see [64]. The URL shall be encoded to an octet string according to UTF-8 encoding rules as  
8 specified in [67].

9

1 **5.2.103 EF<sub>WAPBrowserBM</sub> (WAP Browser Bookmarks)**

2 If service n37 (WAP Browser) is allocated, this EF shall be present.

3 This EF contains bookmarks that may be provisioned by the operator and/or updated by the  
4 user.

5

Identifier: '6F8B'		Structure: Transparent		Optional
File Size: Variable			Update activity: High	
Access Conditions:				
READ		PIN		
UPDATE		PIN		
INVALIDATE		ADM		
REHABILITATE		ADM		
Bytes	Description	M/O	Length	
1 to $X_1$	Bookmark TLV object	M	$X_1$ bytes	
$X_1+1$ to $X_1+X_2$	Bookmark TLV Object	O	$X_2$ bytes	
...	...	O	...	
$X_1+X_2+\dots+X_{n-1}+1$ to $X_1+X_2+\dots+X_{n-1}+X_n$	Bookmark TLV Object	O	$X_n$ bytes	

6  
7 Unused bytes shall be set to 'FF.' A value of 'FF' in place of Bookmark Tag field indicates the end  
8 of valid data.

9 • **Bookmark TLV object contents:**

Description	Value	M/O	Length (bytes)
Bookmark Tag	'AD'	M	1
Length	Note 1	M	Note 2
URL Tag	'80'	M	1
Length	Y	M	Note 2
URL Information	--	M	Y
Bookmark Name Tag	'81'	O	1
Length	Z	O	Note 2
Bookmark Name Information	--	O	Z
NOTE 1: This is the total size of the constructed TLV object object (not including the tag and this length).			
NOTE 2: The length is coded according to [60] using primitive encoding and the minimum number of octets.			

- 1 • **URL Information:** For contents and syntax of URL TLV data object values, see [64]. The URL  
2 shall be encoded to an octet string according to UTF-8 encoding rules, as specified in [67].
  
- 3 • **Bookmark Name Information:** This field shall be encoded to an octet string according to  
4 UTF-8 encoding rules as specified in [67].

1 **5.2.104 EF<sub>MMSConfig</sub> (MMS Configuration)**

2 If services n19 (Multimedia Messaging Service) and n35 (Messaging and 3GPD Extensions) are  
 3 allocated, this EF shall be present.

4 This EF contains the configuration of MMS.

5 Note that this EF does not contain configuration associated with how the MMS client connects to  
 6 the MMS service. This type of configuration information is included in EF<sub>MMSICP</sub>.

7

Identifier: '6F8C'		Structure: Transparent		Optional
File size: 8 bytes			Update Activity: Medium	
Access Conditions:				
READ		PIN		
UPDATE		ADM		
INVALIDATE		ADM		
REHABILITATE		ADM		
Bytes	Description	M/O	Length	
1-4	Max Message Size Value	M	4 bytes	
5	Retry Times Value	M	1 byte	
6	Retry Interval Value	M	1 byte	
7-8	MMSC Timeout Value	M	2 bytes	

8

- 9 • **Max Message Size:** This is the maximum MMS message size (in bytes) allowed by the operator.  
 10 Coding: 32-bit integer.

11 Byte 1:

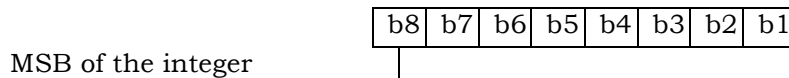

12 Byte 2:

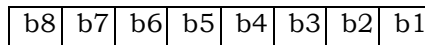

13 Byte 3:

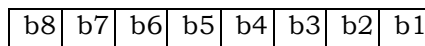

14 Byte 4:

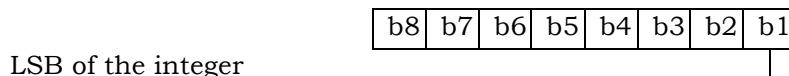

- 1 • **Retry Times:** This is the number of times the MMS application will retry for sending a  
2 message. Coding: 8-bit integer.
  
- 3 • **Retry Interval:** This is the number of seconds to wait before the next retry is attempted.  
4 Coding: 8-bit integer.
  
- 5 • **MMSC Timeout:** This is the number of seconds for the device to wait for response from Mobile  
6 Messaging Service Center (MMSC) before declaring it as an MMSC timeout.
  
7 **Coding:** 16-bit integer.

8 Byte 1:

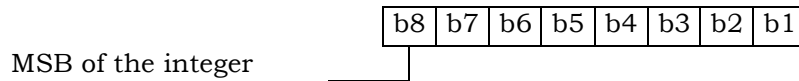

9 Byte 2:

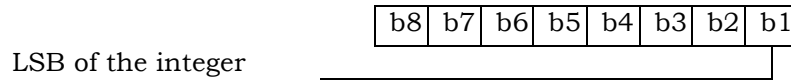

10

1 **5.2.105 EF<sub>JDL</sub> (Java Download URL)**

2 If service n38 (Java) is allocated, this EF shall be present.

3 This EF contains the information for downloading Java applications from the Java download  
4 server.

5

Identifier: '6F8D'		Structure: Transparent		Optional	
File size: Y≥X bytes			Update Activity: Low		
Access Conditions:					
READ		PIN			
UPDATE		ADM			
INVALIDATE		ADM			
REHABILITATE		ADM			
Bytes	Description	M/O	Length		
1-X	Java Download URL	M	X bytes		

6 Unused bytes shall be set to 'FF.'

- 7 • **Java Download URL:** This field of X bytes contains the URL for the Java download server and  
8 a termination byte. For contents and syntax, see [64]. The URL shall be encoded as an octet  
9 string according to UTF-8 encoding rules, as specified in [67]. The termination byte is set to  
10 '00'.

11

1 **5.2.106 EF<sub>ARR</sub> (Access Rule Reference)**

2 This EF contains the access rules for files located under the CSIM ADF in the UICC. For the EF  
3 structure and description refer to Section 4.2.55 of [30].

4 **5.3 Contents of DFs at the CSIM ADF (Application DF) level**

5 DFs may be present as child directories of CSIM ADF. For this revision, the following DF is  
6 defined:

- 7 - DF<sub>PHONEBOOK</sub> '5F3A'.  
8

9 Note: The DF<sub>PHONEBOOK</sub> under CSIM ADF (DF for application specific phonebook) has the same  
10 structure as the DF<sub>PHONEBOOK</sub> under DF<sub>TELECOM</sub>.  
11

12 **5.3.1 Contents of files at the DF<sub>PHONEBOOK</sub> level**

13 The DF<sub>PHONEBOOK</sub> for CSIM shall comply with all requirements specified in [30] Section 4.4.2, with a  
14 restriction that SFI shall not apply to the CSIM. In the context of 3GPP2 systems, "USIM" and  
15 "SIM" shall be interpreted as "CSIM" and "R-UIM" respectively.  
16

## 1 **5.4 Contents of EFs at the DF<sub>TELECOM</sub> level**

### 2 **5.4.1 EF<sub>ADN</sub> (Abbreviated dialing numbers)**

3 If DF<sub>CDMA</sub> [46] is present on the UICC, the first EF<sub>ADN</sub> (i.e. reflected by the first record in EF<sub>PBR</sub>) of  
 4 the DF<sub>PHONEBOOK</sub> is mapped to the EF<sub>ADN</sub> under DF<sub>TELECOM</sub> (with an identifier equal to '6F3A') to  
 5 ensure backwards compatibility.

6 An ME shall not access this file. The information is accessible for the ME in EF<sub>ADN</sub> under  
 7 DF<sub>PHONEBOOK</sub>.

### 8 **5.4.2 EF<sub>EXT1</sub> (Extension 1)**

9 If DF<sub>CDMA</sub> [46] is present on the UICC, the first EF<sub>EXT1</sub> (i.e. reflected by the first record in EF<sub>PBR</sub>) of  
 10 the DF<sub>PHONEBOOK</sub> is mapped to the EF<sub>EXT1</sub> under DF<sub>TELECOM</sub> (with an identifier equal to '6F4A') to  
 11 ensure backwards compatibility.

12 An ME shall not access this file. The information is accessible for the ME in EF<sub>EXT1</sub> under  
 13 DF<sub>PHONEBOOK</sub>.

### 14 **5.4.3 EF<sub>ECCP</sub>, EF<sub>CCP1</sub>, EF<sub>CCP</sub>**

15 If DF<sub>CDMA</sub> is present on the UICC, the first EF<sub>CCP1</sub> (i.e. reflected by the first record in EF<sub>PBR</sub>) of the  
 16 DF<sub>PHONEBOOK</sub> under DF<sub>CDMA</sub> is mapped to the EF<sub>CCP1</sub> under DF<sub>TELECOM</sub> (with an identifier equal to  
 17 '6F4F') to ensure backwards compatibility. There shall not be any EF<sub>CCP</sub> (with a file-id of '6F3D')  
 18 under DF<sub>TELECOM</sub> because otherwise a R-UIM ME could create inconsistencies within the  
 19 phonebook.

20 An ME shall not access this file. The information is accessible for the ME in EF<sub>CCP1</sub> under  
 21 DF<sub>PHONEBOOK</sub>.

### 22 **5.4.4 EF<sub>SUME</sub> (Set Up Menu Elements)**

23 This File is defined in [54], and has the file identifier '6F54'.

### 24 **5.4.5 EF<sub>ARR</sub> (Access Rule Reference)**

25 This EF contains the access rules for files located under the DF<sub>TELECOM</sub> in the UICC. If the security  
 26 attribute tag '8B' is indicated in the FCP it contains a reference to a record in this file.

27 This EF contains one or more records containing access rule information according to the  
 28 reference to expanded format as defined in [53]. Each record represents an access rule. Unused  
 29 bytes in the record are set to 'FF'.

30 If the card cannot access EF<sub>ARR</sub>, any attempt to access a file with access rules indicated in this  
 31 EF<sub>ARR</sub> shall not be granted.

## 5.5 Contents of DFs at the DF<sub>TELECOM</sub> level

DFs may be present as child directories of DF<sub>TELECOM</sub>. The following DFs have been defined:

- DF<sub>GRAPHICS</sub> '5F50'.
- DF<sub>PHONEBOOK</sub> '5F3A'.

(DF for public phone book. This DF has the same structure as DF<sub>PHONEBOOK</sub> under ADF CSIM).

- DF<sub>MULTIMEDIA</sub> '5F3B'.
- DF<sub>MMSS</sub> '5F3C'.

The DFs and EFs under DF<sub>TELECOM</sub> are defined in [45] and [30]. The files defined under DF<sub>MMSS</sub> (file identifier '5F3C') in DF<sub>TELECOM</sub> are used by CSIM for MMSS support and defined in [45]. This DF shall be present if the card supports MMSS.

### 5.5.1 Contents of files at the DF<sub>GRAPHICS</sub> level

The DF<sub>GRAPHICS</sub> for CSIM shall comply with all requirements specified in [30] Section 4.6.1.

### 5.5.2 Contents of files at the DF<sub>PHONEBOOK</sub> under the DF<sub>TELECOM</sub>

This DF has the same structure as DF<sub>PHONEBOOK</sub> under the ADF<sub>CSIM</sub>.

### 5.5.3 Contents of files at the DF<sub>MULTIMEDIA</sub> level

The EFs in the DF<sub>MULTIMEDIA</sub> contain multimedia information. This DF shall be present if service n30 is available, i.e. if the card supports MMS storage.

The EFs in the DF<sub>MULTIMEDIA</sub> for CSIM shall comply with all requirements specified in Section 4.6.3.1 of [30] for EF<sub>MML</sub> (Multimedia Messages List) and 4.6.3.2 of [30] for EF<sub>MMDF</sub> (Multimedia Messages Data File). In the context of 3GPP2 systems, reference to [Informative 2] and [Informative 3] shall be interpreted as a reference to [45] and [37] respectively.

### 5.5.4 Contents of files at the DF<sub>MMSS</sub> level

The EFs in the DF<sub>MMSS</sub> contain multimode system selection parameters and settings. The following EFs which support MMSS are defined in Section 4.1 [45].

- EF<sub>MLPL</sub> – File identifier is '4F20'.
- EF<sub>MSPL</sub> – File identifier is '4F21'.
- EF<sub>MMSSMODE</sub> – File identifier is '4F22'.

These EFs can be queried and updated using the CSIM commands defined in section 9.4.2 (OTASP/OTAPA-related Commands).

## 6. INTERWORKING OF R-UIM & CSIM APPLICATION ON A UICC

An R-UIM [46] and a CSIM implemented together on a single UICC can never be activated at the same time. Neither can they be switched from one to the other. Their activities solely depend on the functionality of ME in which they are inserted: an ME supporting the CSIM shall use the CSIM rather than the R-UIM.

However, both applications may share certain elements to optimize memory consumption, but still, both applications have to be virtually independent from the functional point of view. The following section describes the possible options.

### 6.1 File Mapping

Many files of R-UIM [46] and CSIM not only have the same name and file identifier (although under different DFs) but are entirely equal by size and content parameters. This generally allows for memory efficient implementation of a CSIM together with an R-UIM, as these files can be shared by both applications, i.e. necessary storage capacity is only required once. Further, shared files speeds up the pre-personalization process as they save valuable programming time.

Therefore, files should be mapped as far as possible, i.e. in all cases where basic properties are equal and identical contents do not conflict with the access by either an R-UIM or a CSIM based ME or with intended subscription differences when separate IMSIs are used.

Annex A gives an overview of the rules for mapping files between an R-UIM and CSIM. A case by case decision should be conducted by the network operator / card manufacturer for each UICC implementation.

**Caution:** It should be noted that file identifiers may differ between the R-UIM and CSIM, while all other file properties are exactly the same.

### 6.2 Reserved

### 6.3 Access conditions

If an EF is accessible in both CSIM and R-UIM operation modes, independent UICC and non-UICC access conditions may be defined for the file. The UICC does not check the consistency of the access conditions in both modes.

Therefore, it is possible that the same EF has different security attributes in UICC and non-UICC operation modes. It is the responsibility of the network operator and the card manufacturer to ensure at the personalization stage that the security attributes for a UICC and non-UICC session are the same, if necessary.

### 6.4 Reserved

## 7. APPLICATION PROTOCOL

The requirements stated in the corresponding section of [45] apply to the CSIM application.

The procedures listed in Section 7.1, "CSIM management procedures," are required for execution of the procedures in the Section 7.2, "CSIM security related procedures," and Section 7.3, "Subscription Related Procedures". The procedures listed in Section 7.2, "CSIM security related procedures," are mandatory. The procedures listed in Section 7.3, are only executable if the associated services, which are optional, are provided in the CSIM. However, if the procedures are implemented, it shall be in accordance with Section 7.3. Section 7.4 describes CCAT related procedures.

### 7.1 CSIM management procedures

If a CSIM application is present on the UICC, an ME shall only use the CSIM application. In this case, a possibly existing R-UIM shall never be used by an ME.

#### 7.1.1 Initialization

##### 7.1.1.1 CSIM Application Selection

After UICC activation (see [45]), the ME selects a CSIM application. If no EFDIR file is found or no CSIM applications are listed in the EFDIR file, the ME may then try to select the R-UIM as specified in [46]. After a successful CSIM application selection, it is the UICC's responsibility to store the selected CSIM AID on the UICC. This application is referred to as the last selected CSIM application. The last selected CSIM application shall be available on the UICC after a deactivation followed by an activation of the UICC.

If a CSIM application is selected using a partial DF name, the partial DF name supplied in the command shall uniquely identify a CSIM application. Furthermore if a CSIM application is selected using a partial DF name as specified in [45] indicating in the SELECT command the last occurrence, the UICC shall select the CSIM application stored as the last CSIM application. If, in the SELECT command, the options first, next/previous are indicated, they have no meaning if an application has not been previously selected in the same session and shall return an appropriate error code.

##### 7.1.1.2 CSIM Initialization

If  $EF_{ME3GPDOPC}$  is present, after the selection of CSIM Application, the CSIM shall set the value of Octet 1 in  $EF_{ME3GPDOPC}$  to '00'.

The ME performs the Emergency Call Codes request.

The ME performs the Preferred Language request.

The ME then runs the user verification procedure as defined in Section 6.4 of [30] (where each instance of USIM is replaced with CSIM and where the disabling of PIN2 is always allowed). If the procedure is not performed successfully, the CSIM initialization stops.

The ME performs the Administrative Data request.

The ME performs the CSIM Service Table request.

1 The ME performs the Enabled Services Table request.

2 The ME performs the OTASP/OTAPA Features request.<sup>7</sup>

3 The ME performs the RUI MID request.

4 The ME performs the “ESN\_MEID\_ME update”.

5 The ME performs the ME-specific Configuration Request update.

6 The ME shall run the following procedures if the ME and the CSIM support the related services:

- 7 - Service Preferences request;
- 8 - AKA (3GCIK) request;
- 9 - IMSI request;
- 10 - Access Overload Class information request;
- 11 - PRL and EPRL request;
- 12 - PUZL request;
- 13 - 3GPD Operation Capabilities update;
- 14 - Device Model update;
- 15 - Multimode Location Association Priority List (MLPL) request;
- 16 - Multimode System Priority List (MSPL) request;
- 17 - Reading of additional EFs depending on the additional services that are supported by both
- 18 the ME and CSIM.

19 After the CSIM initialization has been completed successfully, the ME is ready for a CSIM session  
20 and shall indicate this to the CSIM by sending a STATUS command with P1 = ‘01’ (current  
21 application is initialized) as defined in section 11.1.2 of [18].

---

<sup>7</sup> The OTASP/OTAPA features request is needed to determine which of the OTASP/OTAPA features and feature protocol revisions are supported by the card. This, in turn, helps the ME determine which of the subsequent OTASP/OTAPA-related requests (e.g. PRL, PUZL) are needed.

### 1 **7.1.2 Session Termination**

2 NOTE: This procedure is not to be confused with the deactivation procedure in defined in [45].

3 The ME shall indicate to the CSIM by sending a STATUS command with P1 = '02' as defined in  
4 section 11.1.2 of [18] that the termination procedure is starting.

5 The ME then deletes all subscriber related information elements from its memory.

6 To actually terminate the session, the ME shall then use one of the mechanisms described in Sec.  
7 8.5.3 of [18].

### 8 **7.1.3 CSIM Application Closure**

9 After termination of the CSIM application session as defined in 7.1.2, the CSIM application may  
10 be closed by closing the logical channels that are used to communicate with this particular CSIM  
11 application.

### 12 **7.1.4 Emergency call codes request**

13 Request: If EF<sub>ECC</sub> is present and if the ME supports ECC, the ME performs the reading  
14 procedure with EF<sub>ECC</sub>. If the user dials a number that matches one of the codes in EF<sub>ECC</sub>, then the  
15 ME shall treat the call as an emergency call as specified in [5].

16 Refer to [45] for ECC handling if the ME initializes both a CSIM and a USIM.

### 17 **7.1.5 Preferred Language request**

18 The CSIM application shall not indicate any language preference. The ME shall use the language  
19 indicated by any other application currently active on the UICC or by default, choose a language  
20 from EF<sub>PL</sub> at the MF level according the procedure defined in [45].

21 If the ME does not support the languages of EF<sub>PL</sub>, then the ME shall use its own internal default  
22 selection.

### 23 **7.1.6 Administrative Data request**

### 24 **7.1.7 The ME performs the reading procedure with EF<sub>AD</sub> and processes the data as 25 appropriateCSIM Service Table request**

26 The ME performs the reading procedure with EF<sub>CSIM\_ST</sub> and processes the data as appropriate.

### 27 **7.1.8 UICC Presence Detection**

28 The ME checks for the presence of the UICC according to section 14.5.2 of [18] within any period  
29 of inactivity no greater than 30 seconds on the UICC-ME interface during a call. If the presence  
30 detection fails, the ME shall terminate the call within 5 seconds after the presence detection fails.  
31 Here a call includes a circuit switched call or an active packet data call.

### 1 **7.1.9 Enabled Services Table request**

2 If Service n32 is available, the ME performs the reading procedure with EF<sub>EST</sub> and processes the  
3 data as appropriate.

### 4 **7.1.10 OTASP/OTAPA Features request**

5 If the ME supports OTASP/OTAPA, the ME performs the reading procedure with EF<sub>OTA</sub> and  
6 processes the data as appropriate.

### 7 **7.1.11 RUIMID request**

8 The ME performs the reading procedure with EF<sub>RUIMID</sub> and processes the data as appropriate.

### 9 **7.1.12 ESN\_MEID\_ME update**

10 The ME sends the “STORE ESN\_MEID\_ME” command (see section 9.4.3.1), transferring its  
11 ESN\_MEID\_ME to the UICC and processes the response as appropriate.

### 12 **7.1.13 ME-specific Configuration Request update**

13 The ME updates the ME-specific Configuration Request Parameters in EF<sub>MCCRP</sub>.

### 14 **7.1.14 Service Preferences request**

15 The ME performs the reading procedure with EF<sub>SP</sub> and processes the data as appropriate.

### 16 **7.1.15 IMSI request**

17 The ME performs the reading procedure with EF<sub>IMSI\_M</sub> and EF<sub>IMSI\_T</sub>.

18 If IMSI\_M\_PROGRAMMED is set to ‘1’, then the ME processes the data as appropriate.

19 If IMSI\_T\_PROGRAMMED is set to ‘1’, then the ME processes the data as appropriate.

### 20 **7.1.16 Access Overload Class information request**

21 The ME performs the reading procedure with EF<sub>ACCOLC</sub> and processes the data as appropriate.

### 22 **7.1.17 PRL and EPRL request**

23 If the ME supports only SSPR\_P\_REV= 1, then the ME performs the reading procedure with EF<sub>PRL</sub>  
24 and processes the data as appropriate. Otherwise, if the ME supports SSPR\_P\_REV ≥ 3, then if  
25 EF<sub>EPRL</sub> is present, then the ME performs the reading procedure with EF<sub>EPRL</sub> and processes the  
26 data as appropriate. Otherwise, if a functional EF<sub>EPRL</sub> is not present, then the ME performs the  
27 reading procedure with EF<sub>PRL</sub> and processes the data as appropriate.

1 **7.1.18 PUZL request**

2 If the ME supports PUZL\_P\_REV  $\geq 2$  and if EF<sub>PUZL</sub> is present, then the ME performs the reading  
3 procedure with EF<sub>PUZL</sub> and processes the data as appropriate.

4 **7.1.19 3GPD Operation Capabilities update**

5 If services n14 or n15 are available for 3GPD Operation Capabilities, the ME:

- 6 - Sets the bit flag for SimpleIP in Octet 1 of EF<sub>ME3GPDOPC</sub> to '1' if the ME supports SimpleIP.
- 7 - Sets the bit flag for MobileIP in Octet 1 of EF<sub>ME3GPDOPC</sub> to '1' if the ME supports MobileIP.
- 8 - Sets the bit flag for MobileIP with SimpleIP Fallback in Octet 1 of EF<sub>ME3GPDOPC</sub> to '1' if the ME  
9 supports MobileIP with SimpleIP Fallback.

10 **7.1.20 Device Model update**

11 If EF<sub>Model</sub> (Device Model Information) is present, the ME updates the model information in EF<sub>Model</sub>.

12 **7.1.21 Multimode Location Association Priority List (MLPL) request**

13 If the ME supports MMSS\_P\_REV  $\geq 1$  and if EF<sub>MLPL</sub> is present, then the ME performs the reading  
14 procedure with EF<sub>MLPL</sub> and processes the data as appropriate.

15 **7.1.22 Multimode System Priority List (MSPL) request**

16 If the ME supports MMSS\_P\_REV  $\geq 1$  and if EF<sub>MSPL</sub> is present, then the ME performs the reading  
17 procedure with EF<sub>MSPL</sub> and processes the data as appropriate.

18 **7.2 CSIM Security Related Procedures**

19 All the security related procedures defined in [46] are applicable to the CSIM application.

20 **7.2.1 AKA (3GCIK)**

21 Requirement: Service n16 "available".

22 Request: If the ME supports AKA, then the ME performs the reading procedure with EF<sub>3GCIK</sub>  
23 and restores the CK and IK from the CSIM to the ME per section 4.11.5 of [46].

24 **7.3 Subscription Related Procedures**

25 **7.3.1 Phone book procedure**

26 The Phone book procedures for CSIM shall comply with all requirements specified in [30] Section  
27 5.3.1.

### 7.3.2 Dialing numbers

Requirements:

- Service n1 "available" for ADN located under the local phonebook;
- Presence of EF<sub>ADN</sub> in EF<sub>PBR</sub> for ADN located under the global phonebook;
- Presence of EF<sub>ANR</sub> in EF<sub>PBR</sub> for ANR;
- Service n2 "available" for FDN;
- Service n4 "available" for SDN;
- Service n27 "available" for EF<sub>OCl</sub>;
- Service n28 "available" for EF<sub>ICl</sub>.

The following procedures may not only be applied to EF<sub>ADN</sub> and its associated extension files EF<sub>CCP1</sub> and EF<sub>EXT1</sub> as described in the procedures below, but also to EF<sub>ANR</sub>, EF<sub>FDN</sub>, EF<sub>SDN</sub>, EF<sub>OCl</sub>, and EF<sub>ICl</sub>, and their associated extension files. If these files are not available, as denoted in the CSIM service table, the current procedure shall be aborted and the appropriate EFs shall remain unchanged.

As an example, the following procedures are described as applied to ADN.

Update: The ME analyzes and assembles the information to be stored as follows (the byte identifiers used below corresponds to those in the definition of the relevant EFs in the present document):

- i) The ME identifies the Alpha-tagging, Capability/Configuration1 Record Identifier and Extension1 Record Identifier.
- ii) The dialing number/SSC string shall be analyzed and allocated to the bytes of the EF as follows:
  - if a "+" is found, the TON identifier is set to "International";
  - if 20 or less "digits" remain, they shall form the dialing number/SSC string;
  - if more than 20 "digits" remain, the procedure shall be as follows:
    - The ME seeks for a free record in EF<sub>EXT1</sub>. If an Extension1 record is not marked as "free", the ME runs the Purge procedure. If an Extension1 record is still unavailable, the procedure is aborted.
    - The first 20 "digits" are stored in the dialing number/SSC string. The value of the length of BCD number/SSC contents is set to the maximum value, which is 11. The Extension1 record identifier is coded with the associated record number in the EF<sub>EXT1</sub>. The remaining digits are stored in the selected Extension1 record where the

1 type of the record is set to "additional data". The first byte of the Extension1 record  
 2 is set with the number of bytes of the remaining additional data. The number of  
 3 bytes containing digit information is the sum of the length of BCD number/SSC  
 4 contents of EF<sub>ADN</sub> and byte 2 of all associated chained Extension1 records  
 5 containing additional data.

6 iii) If a called party subaddress is associated to the ADN/SSC the procedure shall proceed  
 7 as follows:

- 8 - If the length of the called party subaddress is less than or equal to 11 bytes:
- 9 - The ME seeks for a free record in EF<sub>EXT1</sub>. If an Extension1 record is not marked as  
 10 "free", the ME runs the Purge procedure. If an Extension1 record is still unavailable,  
 11 the procedure is aborted.
- 12 - The ME stores the called party subaddress in the Extension1 record, and sets the  
 13 Extension1 record type to "called party subaddress".
- 14 - If the length of the called party subaddress is greater than 11 bytes:
- 15 - The ME seeks for two free records in EF<sub>EXT1</sub>. If no such two records are found,  
 16 the ME runs the Purge procedure. If two Extension1 records are still unavailable,  
 17 the procedure is aborted.
- 18 - The ME stores the called party subaddress in the two Extension1 records. The  
 19 identifier field in the Extension1 record containing the first part of the  
 20 subaddress data is coded with the associated EF<sub>EXT1</sub> record number containing  
 21 the second part of the subaddress data. Both Extension1 record types are set to  
 22 "called party subaddress".

23 Once i), ii), and iii) have been considered the ME performs the updating procedure with EF<sub>ADN</sub>. If the  
 24 CSIM has no available empty space to store the received ADN/SSC, or if the procedure has been  
 25 aborted, the ME advises the user.

26 For reasons of memory efficiency, the ME may analyze all Extension1 records to recognize if the  
 27 additional or subaddress data to be stored already exists in EF<sub>EXT1</sub>. In this case, the ME may use the  
 28 existing chain or the last part of the existing chain from more than one ADN. The ME is only allowed  
 29 to store extension data in unused records. If existing records are used for multiple accesses, the ME  
 30 shall not change any data in those records to prevent corruption of existing chains.

31 Erasure: The ME sends the identification of the information to be erased. The content of the  
 32 identified record in EF<sub>ADN</sub> is marked as "free".

33 Request: The ME sends the identification of the information to be read. The ME shall analyze  
 34 the data of EF<sub>ADN</sub> to ascertain whether additional data is associated in EF<sub>EXT1</sub> or  
 35 EF<sub>CCP1</sub>. If necessary, then the ME performs the reading procedure on these EFs to  
 36 assemble the complete ADN/SSC.

1 Purge: The ME shall access each EF which references EF<sub>EXT1</sub> for storage and shall identify  
 2 records in these files using extension data (additional data or called party  
 3 subaddress). Note that existing chains have to be followed to the end. All referred  
 4 Extension1 records are noted by the ME. All Extension1 records not noted are then  
 5 marked by the ME as "free" by setting the whole record to 'FF'.

6 The following procedure is only applicable to service n2 (FDN).

7 FDN capability request. If the FDN service is available (see section 5.2.18), the ME shall check the  
 8 if the FDN service is "enabled" or "disabled" (see section 5.2.80 EF<sub>EST</sub>). If the FDN service is  
 9 "enabled", the ME shall only allow outgoing calls to one of the numbers in EF<sub>FDN</sub>.

10 Refer to [45] for FDN handling if the ME initializes both a CSIM and a USIM.

### 11 7.3.3 Short Message

12 Requirement: Service n6 "available".

13 Request: The CSIM seeks for the identified short message. If this message is found, the ME  
 14 performs the reading procedure with EF<sub>SMS</sub>.

15 If the short message is not found within the CSIM memory, the CSIM indicates that  
 16 to the ME.

17 Update: The ME looks for the next available area to store the short message. If such an area  
 18 is available, it performs the updating procedure with EF<sub>SMS</sub>.

19 If there is no available empty space in the CSIM to store the received short message,  
 20 a specific user interaction will have to take place in order not to lose the message.

21 Erasure: The ME will select in the CSIM the message area to be erased. Depending on the UI,  
 22 the message may be read before the area is marked as "free". After performing the  
 23 updating procedure with EF<sub>SMS</sub>, the memory allocated to this short message in the  
 24 CSIM is made available for a new incoming message. The memory of the CSIM may  
 25 still contain the old message until a new message is stored in this area.

26 If b6 of byte 1 in EF<sub>SMS</sub> is set to '1' (the message in the corresponding record is  
 27 protected), then a specific user interaction may take place in order not to lose the  
 28 message.  
 29

1 **7.3.4 Void**

2 **7.3.5 Group Identifier level 1**

3 Requirement: Service n23 "available".

4 Request: The ME performs the reading procedure with EF<sub>GID1</sub>.

5 **7.3.6 Group Identifier level 2**

6 Requirement: Service n24 "available".

7 Request: The ME performs the reading procedure with EF<sub>GID2</sub>.

8 **7.3.7 Service provider name**

9 Requirement: Service n10 "available".

10 Request: The ME performs the reading procedure with EF<sub>SPN</sub>.

11 **7.3.8 Depersonalisation Control Keys**

12 Requirement: Service n25 "available".

13 Request: The ME performs the reading procedure with EF<sub>DCk</sub>.

14 **7.3.9 Co-operative Network List**

15 Requirement: Service n26 "available".

16 Request: The ME performs the reading procedure with EF<sub>CDMACNL</sub>.

17 **7.3.10 MMS Notifications**

18 Requirement: Service n19 "available".

19 Request: The ME sends the identification of the information to be read, and then the ME  
20 performs the reading procedure with EF<sub>MMSN</sub>. If Service n20 is available the ME  
21 shall analyze the data of EF<sub>MMSN</sub> to ascertain, whether additional data is associated  
22 in EF<sub>EXT8</sub>. If necessary, then the ME performs the reading procedure on EF<sub>EXT8</sub> to  
23 assemble the complete MMS notification.

24 Update: The ME analyzes and assembles the MMS notification to be stored as follows:

- 25
- if the MMS notification contains not more bytes than the maximum possible  
26 number for EF<sub>MMSN</sub> then the ME looks for the next available area to store the  
27 MMS notification. If such an area is available, it performs the updating  
28 procedure with EF<sub>MMSN</sub>.

- 1 • if the MMS notification contains more bytes than the maximum possible number
- 2 for  $EF_{MMSN}$  then the ME seeks for a sufficient number of free records in  $EF_{EXT8}$  to
- 3 store the complete MMS notification.
- 4 - If there is not a sufficient number of  $EF_{EXT8}$  records marked as "free" to store
- 5 the complete MMS notification, the procedure is aborted.
- 6 - Otherwise, the ME performs the updating procedure and stores as many bytes
- 7 as possible in  $EF_{MMSN}$ . The Extension file record number of  $EF_{MMSN}$  is coded
- 8 with the associated record number in the  $EF_{EXT8}$ . The remaining bytes are
- 9 stored in the selected  $EF_{EXT8}$  record where the type of the record is then set to
- 10 "additional data". The second byte of the  $EF_{EXT8}$  record is set with the number
- 11 of bytes of the remaining additional data. It is possible, if the number of
- 12 additional digits exceeds the capacity of the additional record, to chain
- 13 another record inside the  $EF_{EXT8}$  by the identifier in the last byte of the record.
- 14 In this case byte 2 of each record for additional data within the same chain
- 15 indicates the number of bytes within the same record.

16 The ME is only allowed to store extension data in unused records of  $EF_{EXT8}$

17 If there is no available empty space in the CSIM to store the MMS notification,  
18 it is up to ME implementation how the notification is handled.

19

20 Erasure: The ME will select in the CSIM the MMS notification to be erased. Depending on the  
21 UI, the MMS notification may be read before the area is marked as "free". The  
22 memory of the CSIM may still contain the old MMS notification until a new message  
23 is stored. If Service n20 is available all associated records in  $EF_{EXT8}$  are then marked  
24 by the ME as "free" by setting them to 'FF'.

### 25 **7.3.11 MMS Issuer Connectivity Parameters**

26 Requirement: Service n19 "available".

27 Request: the ME performs the reading procedure with  $EF_{MMSICP}$ .

28 Update: The ME performs the updating procedure with  $EF_{MMSICP}$ .

### 29 **7.3.12 MMS User Preferences**

30 Requirement: Service n19 "available".

31 Request: the ME performs the reading procedure with  $EF_{MMSUP}$ .

32 Update: The ME performs the updating procedure with  $EF_{MMSUP}$ .

### 1 **7.3.13 MMS User Connectivity Parameters**

2 Requirement: Service n19 and n21 "available".

3 Request: the ME performs the reading procedure with EF<sub>MMSUCP</sub>.

4 Update: The ME performs the updating procedure with EF<sub>MMSUCP</sub>.

### 5 **7.3.14 Multimedia Message Storage**

6 If the ME supports Multimedia Message Storage on the CSIM, then the following procedures apply.  
7 As defined in [37] a Multimedia Message (MM) consists of content, or multimedia objects, and  
8 headers to describe various properties of that content. An MM is stored in EF<sub>M MDF</sub>[30], a BER-TLV  
9 structured file.

10 A list of multimedia messages is stored in the BER-TLV file EF<sub>M ML</sub>[30] where each data object  
11 identifies one Multimedia Message stored in EF<sub>M MDF</sub>[30].

12 Requirement: Service n30 "available".

13 Request: The ME performs the reading procedures on EF<sub>M ML</sub>[30] to verify the presence and to  
14 get the location information of the targeted MM. Then the ME performs the reading  
15 procedure of the EF<sub>M MDF</sub>[30] file to get the MM.

16 Update: The ME chooses a free identity (i.e. not listed in EF<sub>M ML</sub>[30]) for the multimedia  
17 message and check for available space in the EF<sub>M MDF</sub>[30] file. This procedure could  
18 be done for each update or once at the startup of the UE and after a REFRESH  
19 command involving one of the DF<sub>M ULTIMEDIA</sub> files. Then the ME performs the following  
20 procedures:

21 If there is no available empty space in the EF<sub>M MDF</sub>[30] file to store the MM, the  
22 procedure is aborted and the user is notified.

23 Else, the ME stores the MM in EF<sub>M MDF</sub>[30], then updates the information in  
24 EF<sub>M ML</sub>[30] accordingly.

25 Erasure: After a successful deletion of an MM in EF<sub>M MDF</sub>[30] the ME updates the information  
26 in EF<sub>M ML</sub>[30] accordingly.

## 27 **7.4 CCAT Related Procedures**

### 28 **7.4.1 Data Download via SMS-PP**

29 Requirement: Service n12 "available".

30 Procedures and commands for Data Download via SMS-PP are defined in [47].

1   **7.4.2   Data Download via SMS Broadcast**

2       Requirement:       Service n11 "available".

3       Procedures and commands for Data Download via SMS Broadcast are defined in [47].

4   **7.4.3   Call Control by CSIM**

5       Requirement:

6               For Voice Call Control, Service n13 "available".

7               For Data Call Control, Service n42 "available".

8               For Mobile Originated SMS Call Control, Service n43 "available".

9       Procedures and commands for Call Control by CSIM are defined in [47].

10   **7.4.4   Image Request**

11       The ME sends the identification of the information to be read. The ME shall analyze the data of  
12       EF<sub>IMG</sub> to identify the files containing the instances of the image. If necessary, then the ME  
13       performs READ BINARY commands on these files to assemble the complete image instance data.

## 8. STRUCTURE OF COMMANDS AND RESPONSES

This section defines the command and response APDU's supported by the UICC.

### 8.1 Command APDU Structure

See [18] section 10.1

#### 8.1.1 Coding of Class byte

See [18] Section 10.1.1 for telecom application and Table 1, below, for CSIM commands.

#### 8.1.2 Coding of Instruction byte

8.1.2.1 Coding of Instruction byte for a telecom application.

See [18] Section 10.1.2

8.1.2.2 Coding of Instruction byte for CSIM

Table 1 depicts coding of additional instruction byte of the commands for CSIM.

**Table 1 Coding of CLA, INS, P1 and P2 Bytes of the CSIM Commands**

COMMAND	CLA	INS	P1	P2
<b>Command APDUs</b>				
<b>Security-related commands</b>				
MANAGE SSD				
UPDATE SSD	8X	'82'	'00'	'00'
CONFIRM SSD			'00'	'01'
BASE STATION CHALLENGE	8X	'8A'		
GENERATE KEY / VPM	8X	'8E'		
AUTHENTICATE	0X	'88'	'00'	
RUN CAVE				'80'
3G ACCESS AKA				'81'
EAP AKA				'82'
<b>OTASP/OTAPA-related commands</b>				
GENERIC KEY GENERATION REQUEST	8X	'50'	'00'	
MS KEY REQUEST				'00'
KEY GENERATION REQUEST				'01'
SERVICE KEY GENERATION REQUEST				'02'
COMMIT	8X	'CC'		
VALIDATE	8X	'CE'		

COMMAND	CLA	INS	P1	P2
<b>Command APDUs</b>				
GENERIC CONFIGURATION REQUEST	8X	'54'	'00'	
CONFIGURATION REQUEST				'00'
SSPR CONFIGURATION REQUEST				'01'
PUZL CONFIGURATION REQUEST				'02'
3GPD CONFIGURATION REQUEST				'03'
MMS CONFIGURATION REQUEST				'04'
SYSTEM TAG CONFIGURATION REQUEST				'05'
MMSS CONFIGURATION REQUEST				'06'
GENERIC DOWNLOAD REQUEST	8X	'56'	'00'	
DOWNLOAD REQUEST				'00'
SSPR DOWNLOAD REQUEST				'01'
PUZL DOWNLOAD REQUEST				'02'
3GPD DOWNLOAD REQUEST				'03'
MMS DOWNLOAD REQUEST				'04'
SYSTEM TAG DOWNLOAD REQUEST				'05'
MMSS DOWNLOAD REQUEST				'06'
OTAPA REQUEST	8X	'EE'	'00'	'00'
SECURE MODE	8X	'4A'		
FRESH	8X	'4C'		
<b>ESN Management command</b>				
STORE ESN_MEID_ME	8X	'DE'		
<b>Packet Data Security-related command</b>				
COMPUTE IP AUTHENTICATION	8X	'80'		
<b>BCMCS-related command</b>				
BCMCS	8X	'58'		
<b>Application Authentication command</b>				
APPLICATION AUTHENTICATION	8X	'5A'		
<b>AKA-related commands</b>				
UMAC GENERATION	8X	'5E'		
CONFIRM_KEYS		'5C'		
<b>LCS-related commands</b>				
S-SAFE VERIFICATION AND DECRYPTION	8X	'40'	'00'	'00'
TLS GENERATE MASTER SECRET		'42'		
TLS GENERATE VERIFY DATA		'44'		'00'
TLS VERIFICATION AND GENERATE KEY BLOCK		'46'		'00'

1

2 **8.1.3 Coding of Parameter bytes**

3 The value of the parameters P1 and P2 depends on the command. If these are a constant value  
4 they are specified in Table 1, above, otherwise in section 9 below.

5 **8.1.4 Coding of Lc bytes**

6 This field encodes the length of the command parameters/data. See [18] Section 10.1.4 and  
7 section 9, below.

8 **8.1.5 Coding of Data part**

9 See [18] Section 10.1.5 and section 9, below.

1 **8.1.6 Coding of Le bytes**

2 This field encodes the maximum length of the command parameters/data. See [18] Section 10.1.6  
3 and section 9, below.

4 **8.2 Response APDU structure**

5 See [18] Section 10.2 and section 9, below.

6

## 9. COMMANDS

### 9.1 Generic Commands

See [18] Section 11.1.

### 9.2 CAT Commands

See [18] Section 11.2.

### 9.3 Data Oriented Commands

See [18] Section 11.3.

### 9.4 CSIM Commands

This section describes the APDU commands, which are only applicable for CSIM. These commands are related to a particular CSIM and shall not be executable unless the CSIM application has been selected and activated, and the current directory is the CSIM ADF or any subdirectory under this ADF and a successful PIN verification procedure has been performed (see Section 7).

#### 9.4.1 Security-related Commands

The commands BASE STATION CHALLENGE, UPDATE SSD and CONFIRM SSD are performed in sequence, as described in [46] Section 4.2, 4.4 and Annex D.

If the CSIM receives a BASE STATION CHALLENGE command, it shall re-start the command sequence.

If T=0 protocol is used, APDU is mapped onto TPDU (see Section 7.3.1.1 in [18]).

##### 9.4.1.1 MANAGE SSD

###### 9.4.1.1.1 Functional Description

- a. MANAGE SSD consists of UPDATE SSD and CONFIRM SSD commands (see [46] Section 4.2).UPDATE SSD

Coded as [46] Section 4.4.1 (UPDATE SSD) except that the coding of CLA, INS, P1 and P2 is defined in Table 1.

- b. CONFIRM SSD

COMMAND	CLASS	INS	P1	P2	Lc	Le
CONFIRM SSD	'8X'	'82'	'00'	'00'	'03'	absent

Command parameters/data:

Octet(s)	Description	Length
1 - 3	AuthBS	3 bytes

1 AuthBS shall be coded as follows:

2 Octet 1:

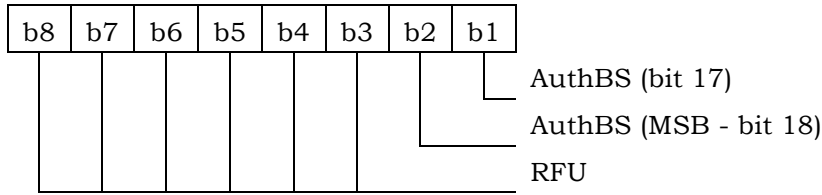

3 Octet 2:

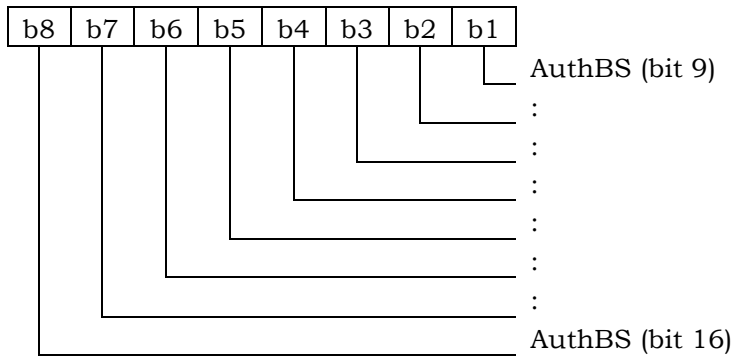

4 Octet 3:

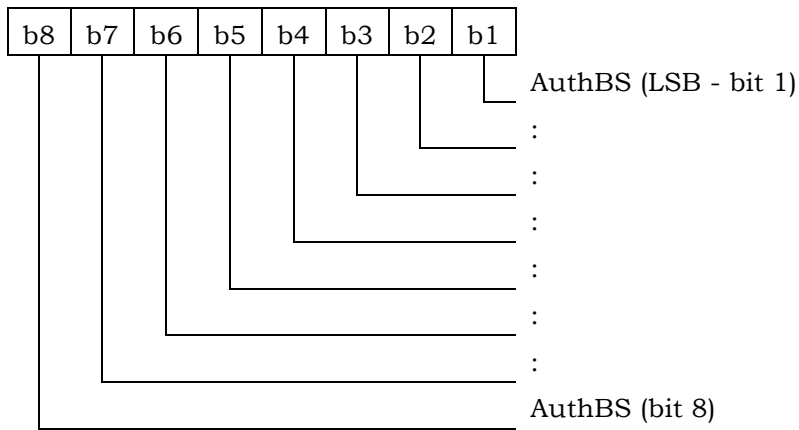

5 Response parameters/data:

6 No response parameters are generated as a result of command execution. Successful  
 7 comparison will cause SW1/SW2 to be set to '90'/'00'. Unsuccessful comparison will  
 8 cause SW1/SW2 to be set to '69'/'82' (Error - Security status not satisfied) [18] Table  
 9 10.13).

10 If the ME is assigned an MEID and if bit1 of the EF<sub>USGIN</sub> is set to '0', then the pESN value  
 11 received in the UPDATE SSD command shall be used as the ESN input to the CAVE  
 12 algorithm for the computation of AuthBS.

13

1 9.4.1.2 BASE STATION CHALLENGE

2 9.4.1.2.1 Functional Description

3 The function of the BASE STATION CHALLENGE command is described in [46] Section 4.2.1  
4 and 4.4.

5 9.4.1.2.2 Command parameters and data

6 Coded as [46] Section 4.4.2, except that CLA and INS bytes shall follow Table 1.

7 9.4.1.3 GENERATE KEY/VPM

8 9.4.1.3.1 Functional Description

9 The function of the GENERATE KEY/VPM command is described in [46] Section 4.2.2.

10 This command relies on the prior successful execution of the AUTHENTICATE - RUN CAVE  
11 command with the "save" function activated (bit 4 of the *Process\_Control* parameter). If this  
12 has not occurred, the status word SW1='98' and SW2='34' [see section 4.2] shall be  
13 returned upon the invocation of this command.

14 9.4.1.3.2 Command parameters and data

15 Coded as [46] Section 4.4.5, except that CLA and INS byte shall follow Table 1.

16 9.4.1.4 AUTHENTICATE

17 9.4.1.4.1 Functional Description

18 This command performs several authentication functions, i.e.: RUN CAVE, 3G ACCESS AKA,  
19 and EAP AKA ( see [46] Section 4.4.4).

20 a. RUN CAVE

21 b. Coded as [46] Section 4.4.4 "Run CAVE" except that CLA, INS, P1 and P2 are defined in  
22 Table 1.3G ACCESS AKA

23 c. Coded as [46] Section 4.4.4 "3G Access AKA" except that CLA, INS, P1 and P2 are defined  
24 in Table 1.EAP AKA

25 Coded as [46] Section 4.4.4 "EAP AKA" except that CLA, INS, P1 and P2 are defined in Table 1.

26 **9.4.2 OTASP/OTAPA-related Commands**

27 This section specifies the CSIM commands which are the mapping of "Request/Response"  
28 messages described in [7] and [46] Section 4.3.

29 9.4.2.1 GENERIC KEY GENERATION REQUEST

30 9.4.2.1.1 Functional Description

31 This command performs several key generation functions, i.e.: MS KEY REQUEST, KEY  
32 GENERATION REQUEST, and SERVICE KEY GENERATION REQUEST, which correspond to  
33 the *MS Key Request/Response*, *Key Generation Request/Response* and *Service Key*  
34 *Generation Request/Response* messages specified in [7].

1 As specified in [7], the KEY GENERATION REQUEST follows the MS KEY REQUEST  
2 function.

3 a. MS KEY REQUEST

4 Coded as [46] Section 4.5.1 except that CLA, INS, P1 and P2 are defined in Table 1.  
5

6 b. KEY GENERATION REQUEST

7 Coded as [46] Section 4.5.2 except that CLA, INS, P1 and P2 are defined in Table 1.  
8

9 c. SERVICE KEY GENERATION REQUEST

10 Coded as [46] Section 4.5.16 except that CLA, INS, P1 and P2 are defined in Table 1.

11 9.4.2.2 COMMIT

12 9.4.2.2.1 Functional Description

13 This command corresponds to the *Commit Request/Response* messages specified in [7],  
14 Sections 4.5.1.6 and 3.5.1.6, respectively.

15 9.4.2.2.2 Command parameters and data

16 Coded as [46] Section 4.5.3, except that CLA and INS are defined in Table 1..

17 9.4.2.3 VALIDATE

18 9.4.2.3.1 Functional Description

19 This command requests the validation of a single block of data and forms a subset of the  
20 *Validation Request Message* as described in [7], Section 4.5.1.10. The response pertains to a  
21 single block of data and forms a subset of the *Validation Response Message* as described in  
22 [7], Section 3.5.1.10.

23 9.4.2.3.2 Command parameters and data

24 Coded as [46] Section 4.5.4, except that the CLA and INS bytes are defined in Table 1.

25 9.4.2.4 GENERIC CONFIGURATION REQUEST

26 9.4.2.4.1 Functional Description

27 This command performs several 'configuration request' functions: CONFIGURATION  
28 REQUEST, SSPR CONFIGURATION REQUEST, PUZL CONFIGURATION REQUEST, 3GPD  
29 CONFIGURATION REQUEST, MMS CONFIGURATION REQUEST, SYSTEM TAG  
30 CONFIGURATION REQUEST and MMSS CONFIGURATION REQUEST which correspond to  
31 *Configuration Request/Response*, *SSPR Configuration Request/Response*, *PUZL Configuration*  
32 *Request/Response*, *3GPD Configuration Request/Response* messages, *MMS Configuration*  
33 *Request/Response*, *System Tag Configuration Request/Response* and *MMSS Configuration*  
34 *Request/Response* as specified in [7].

35 a. CONFIGURATION REQUEST

36 Coded as [46] Section 4.5.5 except that CLA, INS, P1 and P2 are defined in Table 1.

1           b. SSPR CONFIGURATION REQUEST

2           Coded as [46] Section 4.5.7 except that CLA, INS, P1 and P2 are defined in Table 1.

3           c. PUZL CONFIGURATION REQUEST

4           Coded as [46] Section 4.5.10 except that CLA, INS, P1 and P2 are defined in Table 1.

5           d. 3GPD CONFIGURATION REQUEST

6           Coded as [46] Section 4.5.12 except that CLA, INS, P1 and P2 are defined in Table 1.

7           e. MMS CONFIGURATION REQUEST

8           Coded as [46] Section 4.5.19 except that CLA, INS, P1 and P2 are defined in Table 1.

9           f. SYSTEM TAG CONFIGURATION REQUEST

10          Coded as [46] Section 4.5.21 except that CLA, INS, P1 and P2 are defined in Table 1.

11          g. MMSS CONFIGURATION REQUEST

12          CLA, INS, P1 and P2 are defined in Table 1. Lc is the length of the command  
13          parameters/data (4) and Le is the maximum length of the response parameters/data (Nr  
14          or greater).

15          The command parameters/data, input parameters and response parameters/data are  
16          coded as specified below.

17          Command parameters/data:

Octet(s)	Description	Length
1	Block ID	1 byte
2 – 3	Request Offset	2 bytes
4	Request Max Size	1 byte

18  
19          This command requests MMSS configuration details of a single block of data and forms a  
20          subset of the “MMSS Configuration Request Message” as described in [7], section 4.5.1.25.

21          Response parameters/data:

Octet(s)	Description	Length
1	Block ID	1 byte
2	Result Code	1 byte
3	Block Length	1 byte
4 – Nr	Param Data	Nr – 3 bytes

22  
23          This response provides MMSS configuration details of a single block of data and forms a  
24          subset of the “MMSS Configuration Response Message” as described in [7], section  
25          3.5.1.25.

## 1 9.4.2.5 GENERIC DOWNLOAD REQUEST

### 2 9.4.2.5.1 Functional Description

3 This command performs several 'download request' functions: DOWNLOAD REQUEST, SSPR  
 4 DOWNLOAD REQUEST, PUZL DOWNLOAD REQUEST, 3GPD DOWNLOAD REQUEST, MMS  
 5 DOWNLOAD REQUEST , System Tag DOWNLOAD REQUEST Request and MMSS  
 6 DOWNLOAD REQUEST which correspond to *Download Request/Response*, *SSPR Download*  
 7 *Request/Response*, *PUZL Download Request/Response* and *3GPD Download*  
 8 *Request/Response* messages, *MMS Download Request/ Response*, *System Tag Download*  
 9 *Request/ Response* and *MMSS Download Request/Response* as specified in [7].

#### 10 a. DOWNLOAD REQUEST

11 Coded as [46] Section 4.5.6 except that CLA, INS, P1 and P2 are defined in Table 1.

#### 12 b. SSPR DOWNLOAD REQUEST

13 Coded as [46] Section 4.5.8 except that CLA, INS, P1 and P2 are defined in Table 1.

#### 14 c. PUZL DOWNLOAD REQUEST

15 Coded as [46] Section 4.5.11 except that CLA, INS, P1 and P2 are defined in Table 1.

#### 16 d. 3GPD DOWNLOAD REQUEST

17 Coded as [46] Section 4.5.13 except that CLA, INS, P1 and P2 are defined in Table 1.

#### 18 e. MMS DOWNLOAD REQUEST

19 Coded as [46] Section 4.5.20 except that CLA, INS, P1 and P2 are defined in Table 1.

#### 20 f. SYSTEM TAG DOWNLOAD REQUEST

21 Coded as [46] Section 4.5.21 except that CLA, INS, P1 and P2 are defined in Table 1.

#### 22 g. MMSS DOWNLOAD REQUEST

23 CLA, INS, P1 and P2 are defined in Table 1. Lc is the length of the command  
 24 parameters/data (4) and Le is the maximum length of the response parameters/data (Nr  
 25 or greater).

1 The command parameters/data, input parameters and response parameters/data are  
 2 coded as below:

3 Command parameters/data:

Octet(s)	Description	Length
1	Block ID	1 byte
2	Block Length	1 byte
3 – Nr	Param Data	Nr – 2 bytes

4

5 This command requests the MMSS download of a single block of data and forms a subset  
 6 of the “MMSS Download Request Message” as described in [7], section 4.5.1.26.

7 Response parameters/data:

Octet(s)	Description	Length
1	Block ID	1 byte
2	Result Code	1 byte
3 – 4	Segment Offset	2 bytes
5	Segment Size	1 byte

8

9 Details of the response are in [7], section 3.5.1.9, “MMSS Download Response Message”.

1 9.4.2.6 OTAPA REQUEST

2 9.4.2.6.1 Functional Description

3 This command corresponds to the *OTAPA Request/Response* messages specified in [7],  
 4 Sections 4.5.1.11 and 3.5.1.11, respectively.

5 9.4.2.6.2 Command parameters and data

6 CLA, INS, P1 and P2 are defined in Table 1. Lc is the length of the command  
 7 parameters/data (12) and Le is the maximum length of the response parameters/data.

8 Command parameters/data:

Octet(s)	Description	Length
1	Start/Stop	1 byte
2 – 5	RANDSeed	4 bytes
6-9	ESN/pESN	7 bytes
10-12	RFU	3 bytes

9

10 The Start/Stop parameter as defined in Section 4.5.1.11 of [7] shall be coded as follows:

11 Octet 1

8	7	6	5	4	3	2	1

RFU  
 Start/Stop field

12

13 Response parameters/data:

Octet(s)	Description	Length
1	Result Code	1 byte
2	NAM_LOCK Indicator	1 byte
3 – 6	RAND OTAPA	4 bytes

14

15 The RAND\_OTAPA (bytes 3-6) is returned if and only if the Result\_Code is '00' and the  
 16 NAM\_LOCK\_STATE is enabled (= '1') and the Start/Stop field was set to '1' (Start) in the OTAPA  
 17 REQUEST command.

18 The NAM\_LOCK Indicator parameter as defined in Section 3.5.1.11 of [7] shall be coded as  
 19 follows:

20 Octet 2

8	7	6	5	4	3	2	1

NAM\_LOCK Indicator  
 RFU

21

1           Details of the response are in [7], sections 3.3.1.11, “OTAPA Request Message Processing”,  
2           and 3.5.1.11, “OTAPA Response Message”.

### 3   9.4.2.7   SECURE MODE

#### 4       9.4.2.7.1   Functional Description

5           This command corresponds to the *Secure Mode Request/Response* messages specified in [7],  
6           Sections 4.5.1.16 and 3.5.1.16, respectively.

#### 7       9.4.2.7.2   Command parameters and data

8           Coded as [46] Section 4.5.14, except that the CLA and INS bytes are defined in Table 1.

### 9   9.4.2.8   FRESH

#### 10      9.4.2.8.1   Functional Description

11           The function of the *FRESH* command is described in [46] Section 4.3.2.17.

#### 12      9.4.2.8.2   Command parameters and data

13           Coded as [46] Section 4.5.15, except that the CLA and INS bytes are defined in Table 1.

1 **9.4.3 ESN Management Commands**

2 9.4.3.1 STORE ESN\_MEID\_ME

3 9.4.3.1.1 Functional Description

Code	Value
CLA	See Table 1
INS	See Table 1
P1	'00' if ME is not assigned with MEID_ME; '01' if ME is assigned with MEID_ME.
P2	'00'
Lc	'08'
Data	See below
Le	Maximum length of the response parameters data (at least 1).

4

5 9.4.3.1.2 Command parameters/data: (P1 = '00'):

Octet(s)	Description	Length
1	ESN_ME Length	1 byte
2 – 5	ESN_ME	4 bytes
6-8	RFU	3 bytes

6

7 Octet 1:

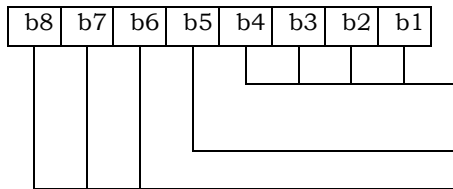

Length of ESN\_ME ( '0100').  
 The ME shall set this bit to '1'. The CSIM shall ignore this bit.  
 RFU

8

Octet 2 – 5:

9 ESN\_ME is encoded with the lowest-order byte first to match the coding for  
 10 EFESN\_MEID\_ME.

11 During the ME and CSIM initialization process, the ME shall invoke the “STORE  
 12 ESN\_MEID\_ME” command to store its ESN\_ME in EF<sub>ESN\_MEID\_ME</sub>.

1 Response parameters/data:

Octet(s)	Description	Length
1	Change Flag, Usage Indicator	1 byte

2 Octet 1:

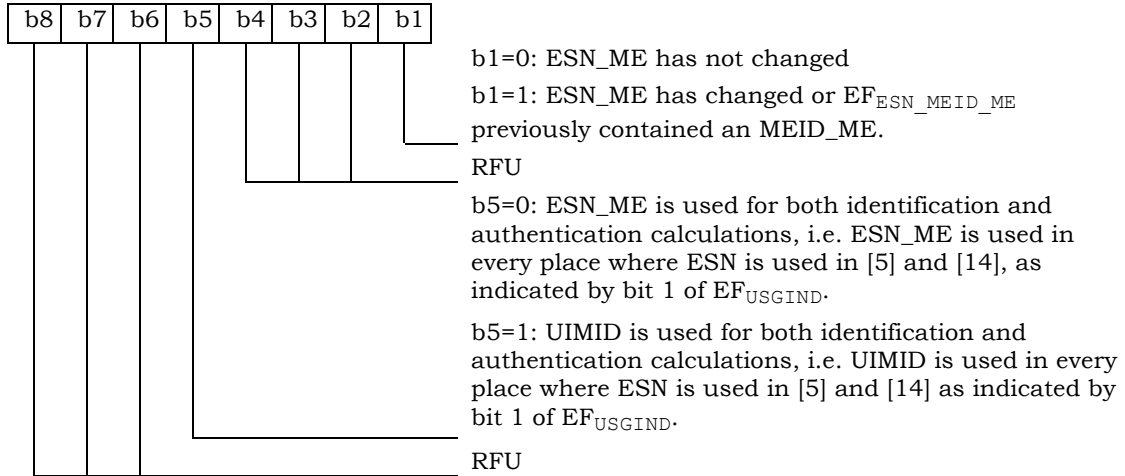

3

4 9.4.3.1.3 Command parameters/data: (P1 = '01'): (assigned with MEID)

Octet(s)	Description	Length
1	MEID_ME Length	1 byte
2 – 8	MEID_ME	7 bytes

5 During the ME and CSIM initialization process, the ME shall invoke the “STORE ESN\_MEID\_ME”  
 6 command to store its MEID\_ME in EF<sub>ESN\_MEID\_ME</sub>. Octet 1:

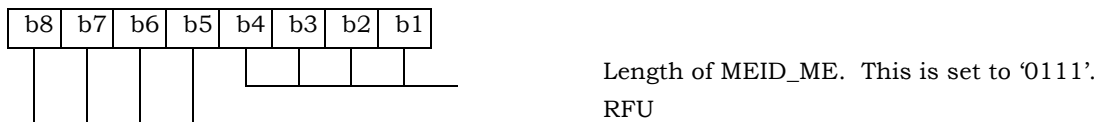

7 Octets 2 – 8:

8 MEID\_ME is encoded with the lowest-order byte first to match the coding for EF<sub>ESN\_MEID\_ME</sub>.

9

1 Response parameters/data:

Octet(s)	Description	Length
1	Change Flag, Usage Indicator	1 byte

2

3

Octet 1:

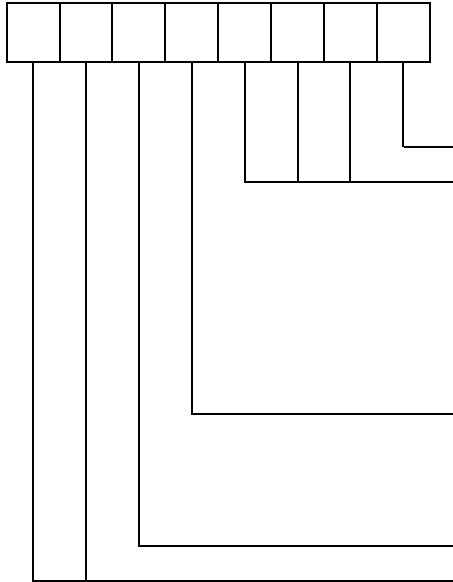

b1=0: MEID\_ME has not changed  
 b1=1: MEID\_ME has changed or EF<sub>ESN\_MEID\_ME</sub> previously contained an ESN\_ME.  
 RFU  
 b5=0: pESN is used for both identification and authentication calculations, i.e. pESN is used in every place where ESN is used in [5] and [14], as indicated by bit 1 of EF<sub>USGIND</sub>.  
 b5=1: UIMID is used for both identification and authentication calculations, i.e. UIMID is used in every place where ESN is used in [5] and [14], as indicated by bit 1 of EF<sub>USGIND</sub>.  
 b6=0: MEID\_ME is used for MS identification, as indicated by bit 2 of EF<sub>USGIND</sub>.  
 b6=1: SF\_EUIMID is used for MS identification, as indicated by bit 2 of EF<sub>USGIND</sub>.  
 RFU

4

5 **9.4.4 Packet Data security-related Commands**

6 9.4.4.1 COMPUTE IP AUTHENTICATION

7 9.4.4.1.1 Functional Description

8 This command computes responses and authenticators for use in Simple IP, Mobile IP and  
 9 HRPD Access Authentication as specified in [46] Section 4.7.

10 9.4.4.1.2 Command parameters and data

11 Coded as [46] Section 4.8.1 except that the CLA and INS bytes are defined in Table 1.

12 **9.4.5 BCMCS-related Commands**

13 9.4.5.1 BCMCS

14 9.4.5.1.1 Functional Description

15 This command is used for BCMCS key management as specified in [46] Section 4.9 and 6.

16 9.4.5.1.2 Command parameters and data

17 Coded as [46] Section 4.9, except that the CLA and INS bytes are defined in Table 1.

1 **9.4.6 Application Authentication Commands**

2 9.4.6.1 APPLICATION AUTHENTICATION

3 9.4.6.1.1 Functional Description

4 The function of the APPLICATION AUTHENTICATION command is described in [46] Section  
5 4.10.

6 9.4.6.1.2 Command parameters and data

7 Coded as [46] Section 4.10, except that the CLA and INS bytes are defined in Table 1.

8 **9.4.7 AKA-related Commands**

9 See section 9.4.1.4 for a description of the 3G ACCESS AKA and EAP AKA AUTHENTICATE  
10 commands.

11 9.4.7.1 UMAC GENERATION

12 9.4.7.1.1 Functional Description

13 The function of the UMAC GENERATION command is described in [46] Section 4.11.

14 9.4.7.1.2 Command parameters and data

15 Coded as [46] Section 4.12.1, except that the CLA and INS bytes are defined in Table 1.

16 9.4.7.2 CONFIRM\_KEYS

17 9.4.7.2.1 Functional Description

18 The function of the CONFIRM\_KEYS command is described in [46] Section 4.11.

19 9.4.7.2.2 Command parameters and data

20 Coded as [46] Section 4.12.2, except that the CLA and INS bytes are defined in Table 1.

1 **9.4.8 LCS-related Commands**

2 The command/response parameters used in this section refers to [50].

3 9.4.8.1 S-SAFE VERIFICATION AND DECRYPTION

4 9.4.8.1.1 Functional Description

5 This command is used to verify the integrity of 'S-SAFE Envelope' and if necessary to decrypt  
 6 LCS\_S\_SAFE\_PAYLOAD afterwards. To perform integrity verification and decryption  
 7 operations, the CSIM calculates a LCS\_S\_SAFE\_KEY, a cipher key and an integrity key. For  
 8 the execution of the command, the CSIM uses the LCS\_ROOT\_KEY, which is stored in the  
 9 CSIM.

10 9.4.8.1.2 Command parameters and data

Code	Value
CLA	See Table 1
INS	
P1	
P2	
Lc	Length of command parameters/data. See below.
Data	See below.
Le	Maximum expected length of response parameters/data. See below.

11

12 Command parameters/data:

Octet(s)	Description	Length
1 to Lc	S-SAFE Envelope	Lc bytes

13

The S-SAFE Envelope formatting details are in Section 5.2.1 of [50].

14

Response parameters/data:

15

The CSIM processes the S-SAFE Envelope as described in Section 5.2.2 of [50].

16

If the value of LCS\_S\_SAFE\_VERSION is not supported then CSIM shall return status words SW1='69' and SW2='85' ("Conditions of use not satisfied")[18].

17

18

If the integrity verification has failed, then the CSIM shall return status words SW1='98' and SW2='62' ("Authentication error, incorrect MAC")[18].

19

20

If the integrity verification succeeds, the CSIM decrypts the LCS\_S\_SAFE\_PAYLOAD. In such a case, the response parameters/data are:

21

Octet(s)	Description	Length
1 to 2	Length of LCS_S_SAFE_DATA	2 bytes
3 to Nr	LCS_S_SAFE_DATA	Nr-2 bytes

9.4.8.2 TLS GENERATE MASTER SECRET

9.4.8.2.1 Functional Description

This command is used to generate the *master\_secret* as described in Section 5.3.8.1 of [50]. The CSIM will assign a *master\_secret\_index* for each generated *master\_secret*. CSIM shall securely store the *master\_secret* and its corresponding *master\_secret\_index*, and shall only return the *master\_secret\_index* to the ME.

In order to generate the *master\_secret*, CSIM first calculates the LCS\_UIM\_HPS\_TLS\_PSK\_KEY for TLS Session-A; or LCS\_UIM\_PDE\_ROOT\_KEY and LCS\_UIM\_PDE\_TLS\_PSK\_KEY for TLS Session-B. For the execution of the command, the CSIM uses the LCS\_ROOT\_KEY, which is stored in the CSIM.

9.4.8.2.2 Command parameters and data

Code	Value
CLA	
INS	See Table 1
P1	
P2	(See Detail 1)
Lc	Length of the command parameters/data. See below
Data	See below
Le	Maximum length of the response parameters/data. See below

**Detail 1:**

If DHE Key exchange is used, then the resulting *other\_secrets* parameter (equal to the shared secret DH key) inside the data field parameter is so large that it is possible to have Lc exceeds 254 bytes. Therefore, this command shall chain successive blocks of with a maximum size of 254 bytes each. If the blocks used within the command are received out of sequence, the card shall return, SW1='98' and SW2='34'. [17]

P2 contains chaining information as follows:

b8	b7	b6	b5	b4	b3	b2	b1	Meaning
0	0	0	0	0	0	0	0	First block
X	X	X	X	0	0	0	1	'xxxx' indicates (n+1) <sup>th</sup> next block. '0000 0001' = 1 <sup>st</sup> next block. '0001 0001' = 2 <sup>nd</sup> next block. '0010 0001' = 3 <sup>rd</sup> next block. ... '1111 0001' = 16 <sup>th</sup> next block.
0	0	0	0	0	0	1	0	Single block
0	0	0	0	0	0	1	1	Last block

\* Le: 'Not present' for P2 = '00' or 'x1'

1 At least 16 for P2 = '02' or '03'

2 Command parameters/data:

3 a. Operation for TLS Session-A (SessionType='01')

4

Octet(s)	Description	Length
1	TLS Service Type (see Table 2 )	1 byte
2	SessionType	1 byte
3 to A+2	TLS Server_Version TLV	A bytes
A+3 to A+B+2	TLS Other_Secret TLV	B bytes
A+B+3 to A+B+C+2	TLS Master_Client_Random TLV	C bytes
A+B+C+3 to A+B+C+D+2	TLS Master_Server_Random TLV	D bytes

NOTE: The tags inside TLV objects in the command are specified in Annex D of this document.

5  
6 The coding for 'TLS Service Type' is defined according to the following table:

7 **Table 2 Coding of 'TLS Service Type'**

Binary Value	Service Type
'00000000'	IP-based Location Services
Others	Reserved

8 For "IP-based Location Services" (i.e. 'TLS Service Type' = '0x00'), see [50] for the definition of  
9 the remaining input parameters.

10  
11 b. Operation for TLS Session-B (SessionType='02')

Octet(s)	Description	Length
1	TLS Service Type (Table 2 )	1 byte
2	SessionType	1 byte
2 to A+2	TLS PSK VERSION TLV	A bytes
A+3 to A+B+2	TLS PSK EXPIRY TLV	B bytes
A+B+3 to A+B+C+2	TLS PSK RAND TLV	C bytes
A+B+C+3 to A+B+C+D+2	TLS PSK EXTRAS TLV	D bytes
A+B+C+D+3 to A+B+C+D+2	TLS Server_Version TLV	E bytes
A+B+C+D+E+3 to A+B+C+D+E+F+2	TLS Other_Secret TLV	F bytes
A+B+C+D+E+F+3 to A+B+C+D+E+F+G+2	TLS Master_Client_Random TLV	G bytes
A+B+C+D+E+F+G+3 to A+B+C+D+E+F+G+H+2	TLS Master_Server_Random TLV	H bytes

NOTE: The tags inside TLV objects in the command are specified in Annex D of this document.

1 Response parameters/data:

Octet(s)	Description	Length
1 to 2	<i>master_secret_index</i>	2 bytes

2 9.4.8.3 TLS GENERATE VERIFY DATA

3 9.4.8.3.1 Functional Description

4 This command is used to generate both TLS Session-A and TLS Session-B client's  
5 *verify\_data*, as described in [50].

6 9.4.8.3.2 Command parameters and data

Code	Value
CLA	See Table 1
INS	
P1	
P2	
Lc	Length of the command parameters/data. See below
Data	See below
Le	Maximum length of the response parameters/data. See below

7

8 Command parameters/data:

Octet(s)	Description	Length
1	TLS Service Type (see Table 2 )	1 byte
2 to 3	TLS Master_Secret_Index TLV	2 bytes
4 to A+3	TLS MS Verify_Digest TLV	A bytes
NOTE: The tags inside TLV objects in the command are specified in Annex D of this document.		

9

10 Response parameters/data:

Octet(s)	Description	Length
1-2	MS Verify Data Length	2 bytes
3 to B+2	MS Verify Data	B bytes

#### 9.4.8.4 TLS VERIFICATION AND GENERATE KEY BLOCK

##### 9.4.8.4.1 Functional Description

This command is used to verify the Server's *verify\_data* from the server (HPS or PDE) during TLS Session-A or TLS Session-B handshake, and then generates the *key\_block* data, as described in [50].

##### 9.4.8.4.2 Command parameters and data

Code	Value
CLA	See Table 1
INS	
P1	
P2	
Lc	Length of the command parameters/data. See below
Data	See below
Le	Maximum length of the response parameters/data. See below

Command parameters/data:

Octet(s)	Description	Length
1	TLS Service Type (see Table 2 )	1 byte
2 to A+1	TLS Server_Version TLV	A bytes
A+2 to A+B+1	TLS Master_Secret_Index TLV	B bytes
A+B+2 to A+B+C+1	TLS Current_Client_Random TLV	C bytes
A+B+C+2 to A+B+C+D+1	TLS Current_Server_Random TLV	D bytes
A+B+C+D+2 to A+B+C+D+E+1	TLS Server_Verify_Digest TLV	E bytes
A+B+C+D+E+2 to A+B+C+D+E+F+1	TLS Server_Verify_Data TLV	F bytes
A+B+C+D+E+F+2 to A+B+C+D+E+F+3	TLS Key_Block_Len	2 bytes
NOTE: The tags inside TLV objects in the command are specified in Annex D of this document.		

Response parameters/data:

Octet(s)	Description	Length
1-2	TLS <i>key_block</i> Length	2 bytes
3 to G+2	TLS <i>key_block</i>	G bytes

If the verification fails, the CSIM shall return a status word SW1='98' and SW2='62' ("Authentication error") [ see section 4.2].

## 1 10. DESCRIPTION OF SERVICES-RELATED PROCEDURE

### 2 10.1 IP-based Location Services Procedures [50]

#### 3 10.1.1 Functionalities of CSIM and ME

##### 4 10.1.1.1 CSIM

- 5 - Generate LCS\_UIM\_S\_SAFE Key, LCS\_UIM\_HPS\_TLS\_PSK Key and LCS\_UIM\_PDE\_ROOT
- 6 Key from LCS Root Key. This may be done at the same time when LCS Root Key is
- 7 provisioned or may be later.
- 8 - Generate LCS\_S\_SAFE\_CK and LCS\_S\_SAFE\_IK from LCS\_UIM\_S\_SAFE Key after
- 9 receiving the 'S-SAFE VERIFICATION AND DECRYPTION' command from the ME, and
- 10 - perform Integrity Verification to LCS\_S\_SAFE\_MAC\_DATA with LCS\_S\_SAFE\_IK, and
- 11 - when necessary, decrypt LCS\_S\_SAFE\_PAYLOAD with LCS\_S\_SAFE\_CK.
- 12 - Compute *master\_secret* with input parameters after receiving the 'TLS GENERATE
- 13 MASTER SECRET' command from the ME, assign a unique 16-bit *master\_secret\_index* for
- 14 the calculated *master\_secret*.
- 15 - Compute Session-A (or Session-B) *verify\_data* with input parameters after receiving the
- 16 'TLS GENERATE VERIFY DATA ' command from the ME.
- 17 - Verify the received H-PS (or PDE) Verify Data and if success then generate a *key\_block*
- 18 from inputs parameters after receiving the 'TLS VERIFICATION AND GENERATE KEY
- 19 BLOCK ' command from the ME.

##### 20 10.1.1.2 ME

- 21 - Perform Expiry Check and Replay Detection against S-SAFE envelop
- 22 - Generate MS Verify Digest.
- 23 - Generate MS *session\_secret*.
- 24 - Perform bulk ciphering and integrity check for TLS Session-A application data with
- 25 Session-A Session Secret
- 26 - Perform bulk ciphering and integrity check for TLS Session-B application data with
- 27 Session-B Session Secret
- 28 - Issue correct command with appropriate parameters to CSIM.
- 29

1 **10.1.2 Key Management**

2 If service n17 is available, these following keys shall be securely maintained in the CSIM:

- 3 - LCS\_ROOT\_KEY.
- 4 - three PSK keys (i.e. LCS\_UIM\_S\_SAFE Key, LCS\_UIM\_HPS\_TLS\_PSK Key and  
5 LCS\_UIM\_PDE\_ROOT Key) derived from LCS\_ROOT\_KEY.
- 6 - *master\_secret* and *master\_secret\_index*

7

8 When ME sends a TLS GENERATE MASTER SECRET' command for TLS Session-B, the CSIM  
9 shall generate a LCS\_UIM\_PDE\_TLS\_PSK\_KEY from LCS\_UIM\_PDE\_ROOT\_KEY and the input  
10 parameter LCS\_UIM\_PDE\_TLS\_PSK\_RAND. LCS\_UIM\_PDE\_TLS\_PSK\_KEY (not the  
11 LCS\_UIM\_PDE\_ROOT Key) shall then be used to generate the requested *master\_secret*.

1 **ANNEX A (INFORMATIVE): R-UIM/CSIM FILE MAPPING TABLE**

2 The following section provides some guidelines for file mapping between an R-UIM and CSIM in a  
3 UICC. It should be noted that some files are optional, and these files are not necessarily present in  
4 the R-UIM or CSIM application. Mapping with multiple CSIM's is not considered.

- 5 1. Files mapped between an R-UIM and a CSIM should be of the same size.
- 6 2. If subscription related information is different across an R-UIM and a CSIM, the files cannot  
7 be mapped.
- 8 3. Mapping is not possible if the file is applicable only either to an R-UIM or a CSIM,  
9 e.g. EF<sub>Revision</sub>.
- 10 4. Case by case analysis has to be done by the network operators/card manufacturers for files to  
11 be mapped that are specific to the terminal, e.g. ESN, MEID files, etc that contains device  
12 specific information.

1 **ANNEX B (NORMATIVE): LIST OF SFI VALUES**

2

File Identification	SFI	Description
'6F43'	'01'	Administrative data
'6F32'	'02'	CSIM Service Table
'6F2C'	'03'	Access Overload Class
'6F22'	'04'	IMSI_M
'6F23'	'05'	IMSI_T
'6F24'	'06'	TMSI
'6F30'	'07'	PRL
'6F41'	'08'	CDMA Home Service Provider Name
'6F47'	'09'	Emergency Call Codes
'6F3A'	'0A'	Language Indication
'6F6B'	'0B'	3G Cipher and Integrity Key
'6F28'	'0C'	CDMA Home SID and NID
'6F2A'	'0D'	CDMA System-Network Registration Indicators
'6F5A'	'0E'	Extended PRL
'6F75'	'0F'	Enabled Services Table
'6F7C'	'10'	Incoming Call Information
'6F7D'	'11'	Outgoing Call Information
'6F7F'	'12'	Capability Control Parameters2

1 **ANNEX C (INFORMATIVE): CSIM APPLICATION SESSION ACTIVATION/TERMINATION**

2 The purpose of this annex is to illustrate the different Application Session procedures.

3

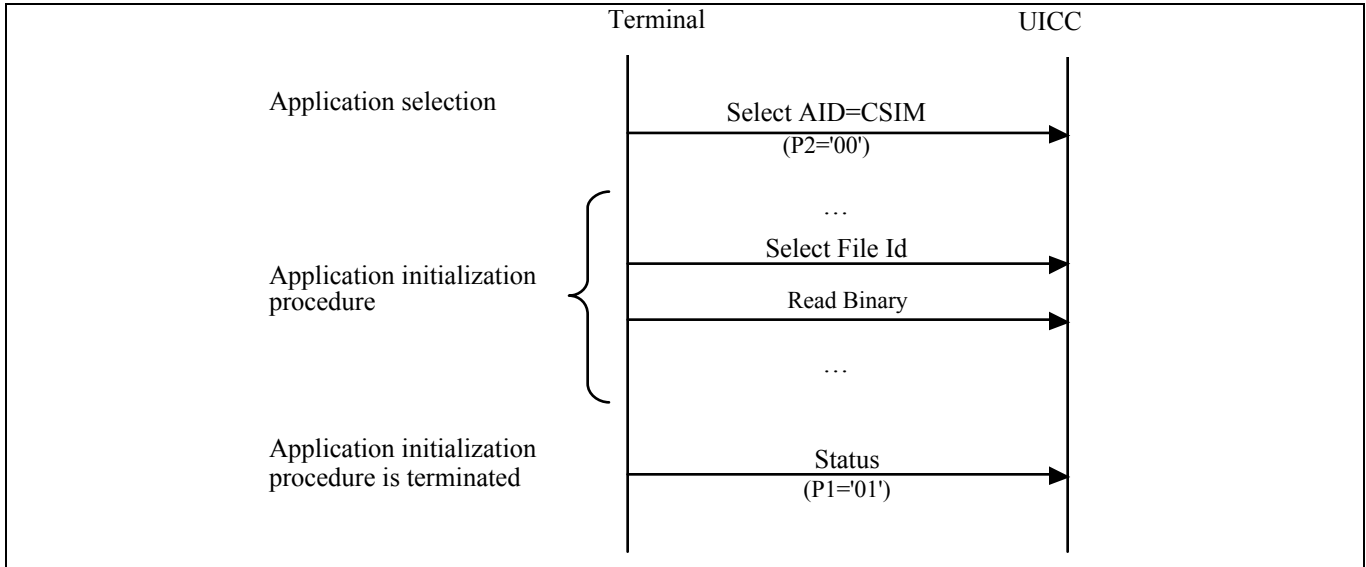

4

5 **Figure 1 CSIM Application Session Activation Procedures**

6

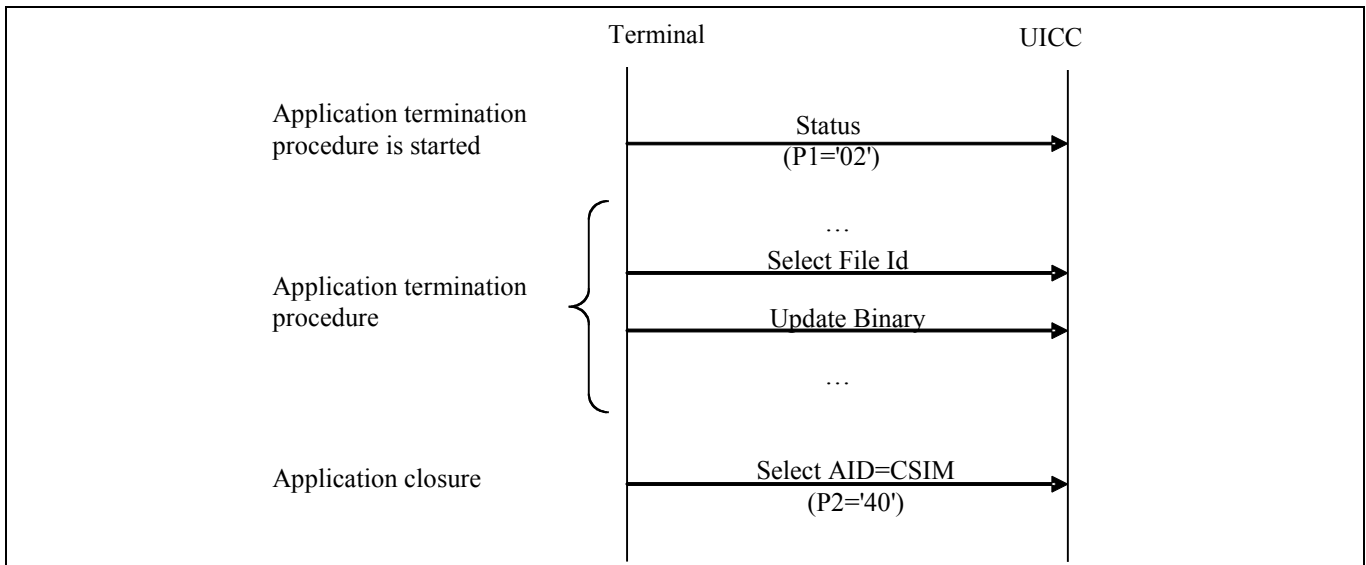

7

8 **Figure 2 CSIM Application Session Termination Procedures**

9

1 **ANNEX D (NORMATIVE): TLS-RELATED TAG VALUES**

2

Tag	Name of Data Element	Usage
'80'	TLS Server_Version TLV objects	TLS command
'81'	TLS Cipher_Suite TLV objects	TLS command
'82'	TLS Other_Secret TLV object	TLS command
'83'	TLS Master_Client_Random TLV object	TLS command
'84'	TLS Master_Server_Random TLV object	TLS command
'85'	TLS Current_Client_Random TLV object	TLS command
'86'	TLS Current_Server_Random TLV object	TLS command
'87'	TLS Server Verify_Digest TLV object	TLS command
'88'	TLS Server Verify_Data TLV object	TLS command
'89'	TLS MS Verify_Digest TLV object	TLS command
'8A'	TLS_Master_Secret_Index TLV object	TLS command
'8B'	TLS PSK VERSION TLV	TLS command
'8C'	TLS PSK EXPIRY TLV	TLS command
'8D'	TLS PSK RAND TLV	TLS command
'8E'	TLS PSK EXTRAS TLV	TLS command

3

1 **ANNEX E (INFORMATIVE): SUGGESTED CONTENTS OF THE EFS AT PRE-**  
 2 **PERSONALIZATION**

3  
 4 Table 3 is a general outline of the CSIM files defined in this specification.

- 5 1. All values are sized in bytes unless otherwise noted.
- 6 2. Default Values are specified when available and are intended to be guidelines only. In some  
 7 cases, operators must specify explicit parameter values as no logical default exists. In the case  
 8 where the parameter values are necessary, valid values and/or ranges are listed.
- 9 3. Default and Parameter values are for general quick reference only and not intended to specify  
 10 details. Refer to the corresponding file for details.
- 11 4. Default Values and Parameter Values are specified in Hexadecimal, unless otherwise noted.
- 12 5. GSM-specific files are not included.
- 13 6. If EFs have an unassigned value, it may not be clear from the main text what this value  
 14 should be. This annex suggests values in these cases.
- 15 7. File sizes are in bytes.
- 16 8. Mandatory files are indicated as 'M' and optional files by 'O'.

17  
 18 **Table 3 Summary of CSIM Files**

File Name	File ID – File Type	Access Read – Update	Access – Invalidate-Rehabilitate	Size – M/O	Default Values (D) and/or Parameter Values (P) in Bytes
<b>Authentication – NAM Parameters and Operational Parameters</b>					
A-Key	---	Never–Never	-	8–M	Specified by Operator
Root Key	---	Never–Never	-	16–M	Specified by Operator
BCMCS Root Key	---	Never–Never	-	16–O	Specified by Operator
IMS Root Key	---	Never–Never	-	16–O	Specified by Operator
WLAN Root Key	---	Never–Never	-	16–O	Specified by Operator
SSD	---	Never–Never	-	16–M	-
EFCOUNT	6F21–CY	PIN–PIN	ADM-ADM	2–M	D = '00 00'
BAK	---	Never–Never	-	16–O	Specified by Operator

File Name	File ID – File Type	Access Read – Update	Access – Invalidate-Rehabilitate	Size – M/O	Default Values (D) and/or Parameter Values (P) in Bytes
UpdatedBAK	---	Never–Never	-	16–O	Specified by Operator
SharedSecret	---	Never–Never	-	Variable–O	Specified by Operator
UAK	---	Never–Never	-	16–O	Specified by Operator
SQNMS	---	Never–Never	-	6–O	-
<b>NAM Parameters and Operational Parameters</b>					
EF <sub>IMSI_M</sub>	6F22–TR	PIN–ADM	ADM-PIN	10–M	P = Specified by Operator or D='00...00'
EF <sub>IMSI_T</sub>	6F23–TR	PIN–ADM	ADM-PIN	10–M	P = Specified by Operator or D='00...00'
EF <sub>TMSI</sub>	6F24–TR	PIN–PIN	ADM-PIN	16–M	D = '00 00 00 00 00 00 00 00 00 00 FF FF FF FF 00 00 00'
EF <sub>AH</sub>	6F25–TR	PIN–PIN	ADM-ADM	2–M	P = Specified by Operator or D = '00 00'
EF <sub>AOP</sub>	6F26–TR	PIN–PIN	ADM-ADM	1–M	-
EF <sub>ALOC</sub>	6F27–TR	PIN–PIN	ADM-ADM	7–M	-
EF <sub>CDMAHOME</sub>	6F28–LF	PIN–PIN	ADM-ADM	5–M	P = Specified by Operator or D = '00 00 00 00 00'
EF <sub>ZNREGI</sub>	6F29–LF	PIN–PIN	ADM-ADM	8–M	D = '00 00 00 00 00 00 00 00'
EF <sub>SNREGI</sub>	6F2A–TR	PIN–PIN	ADM-ADM	7–M	-
EF <sub>DISTREGI</sub>	6F2B–TR	PIN–PIN	ADM-ADM	8–M	D = '00 00 00 00 00 00 00 00'
EF <sub>ACCOLC</sub>	6F2C–TR	PIN–ADM	ADM-ADM	1–M	P = '00' to '0F' derived from IMSI_M / IMSI_T
EF <sub>TERM</sub>	6F2D–TR	PIN–PIN	ADM-ADM	1–M	Specified by Operator P = '00' to '07'
EF <sub>SSCI</sub>	6F2E–TR	PIN–PIN	ADM-ADM	1–O	Specified by Operator P = '00' to '07'
EF <sub>ACP</sub>	6F2F–TR	PIN–PIN	ADM-ADM	7–M	Specified by Operator
EF <sub>PRL</sub>	6F30–TR	PIN–ADM	ADM-ADM	Variable–M	Specified by Operator
EF <sub>RUI MID</sub>	6F31–TR	ALW–Never	Never-Never	8–M	Specified by CSIM Manufacturer
EF <sub>CSIM_ST</sub>	6F32–TR	PIN–ADM	ADM-ADM	Variable–M	Specified by Operator

File Name	File ID – File Type	Access Read – Update	Access – Invalidate-Rehabilitate	Size – M/O	Default Values (D) and/or Parameter Values (P) in Bytes
EF <sub>SPC</sub>	6F33–TR	ADM–ADM	ADM-ADM	3–M	D = '00 00 00' or P = '00 00 00' to '99 99 99'
EF <sub>OTAPASPC</sub>	6F34–TR	PIN–PIN	ADM-ADM	1–M	Specified by Operator or D = '00'
EF <sub>NAMLOCK</sub>	6F35–TR	PIN–PIN	ADM-ADM	1–M	Specified by Operator
EF <sub>OTA</sub>	6F36–TR	PIN–ADM	ADM-ADM	Variable–M	P = Defined in [7]
EF <sub>SP</sub>	6F37–TR	PIN–PIN	ADM-ADM	1–M	Specified by Operator
EF <sub>ESN_MEID_ME</sub>	6F38–TR	ALW–ADM	ADM-ADM	8–M	D = '00...00'
EF <sub>LI</sub>	6F3A–TR	ALW–PIN	ADM-ADM	Variable–M	D = 'FF... FF'
EF <sub>FDN</sub>	6F3B–LF	PIN–PIN2	ADM-ADM	Variable–O	D = 'FF...FF'
EF <sub>SMS</sub>	6F3C–LF	PIN–PIN	ADM-ADM	Variable–O	D = '00 FF...FF'
EF <sub>SMSP</sub>	6F3D–LF	PIN–PIN	ADM-ADM	Variable–O	D = 'FF...FF'
EF <sub>SMSS</sub>	6F3E–TR	PIN–PIN	ADM-ADM	Variable–O	D = 'FF...FF'
EF <sub>SSFC</sub>	6F3F–TR	PIN–PIN	ADM-ADM	Variable–O	Specified by Operator
EF <sub>SPN</sub>	6F41–TR	ALW–ADM	ADM-ADM	35–O	Specified by Operator
EF <sub>USGIND</sub>	6F42–TR	PIN–ADM	ADM-ADM	1–M	Specified by Operator
EF <sub>AD</sub>	6F43–TR	ALW–ADM	ADM-ADM	Variable–M	D = '00...00'
EF <sub>MDN</sub>	6F44–LF	PIN–PIN	ADM-ADM	11–O	Specified by Operator
EF <sub>MAXPRL</sub>	6F45–TR	PIN–ADM	ADM-ADM	2 or 4–M	Specified by Operator
EF <sub>SPCS</sub>	6F46–TR	PIN–Never	Never-Never	1–M	P = If EF 6F33 is set to default value then D = '00' otherwise D = '01'
EF <sub>ECC</sub>	6F47–TR	ALW–ADM	ADM-ADM	Variable–O	D = 'FF'
EF <sub>ME3GPDOPC</sub>	6F48–TR	PIN–PIN	ADM-ADM	1–O	D = '00'
EF <sub>3GPDOPM</sub>	6F49–TR	PIN–ADM	ADM-ADM	1–O	Specified by Operator
EF <sub>SIPCAP</sub>	6F4A–TR	PIN–ADM	ADM-ADM	4–O	Specified by Operator
EF <sub>MIPCAP</sub>	6F4B–TR	PIN–ADM	ADM-ADM	5–O	Specified by Operator
EF <sub>SIPUPP</sub>	6F4C–TR	PIN–ADM	ADM-ADM	Variable–O	Specified by Operator
EF <sub>MIPUPP</sub>	6F4D–TR	PIN–ADM	ADM-ADM	Variable–O	Specified by Operator
EF <sub>SIPSP</sub>	6F4E–TR	PIN–PIN	ADM-ADM	1–O	Specified by Operator
EF <sub>MIPSP</sub>	6F4F–TR	PIN–PIN	ADM-ADM	Variable–O	Specified by Operator

File Name	File ID – File Type	Access Read – Update	Access – Invalidate-Rehabilitate	Size – M/O	Default Values (D) and/or Parameter Values (P) in Bytes
EF <sub>SIPPAPSS</sub>	6F50–TR	PIN–PIN	ADM-ADM	Variable–O	Specified by Operator
SimpleIP CHAP SS	---	Never–Never	-	Variable–O	Specified by Operator
MobileIP SS	---	Never–Never	-	Variable–O	Specified by Operator
Shared Secret	---	Never–Never	-	Variable–O	Specified by Operator
EF <sub>PUZL</sub>	6F53–TR	PIN–ADM	ADM-ADM	Variable–O	Specified by Operator
EF <sub>MAXPUZL</sub>	6F54–TR	PIN–ADM	ADM-ADM	5–O	Specified by Operator
EF <sub>MECRP</sub>	6F55–TR	PIN–PIN	ADM-ADM	3–M	D = '00 00 00'
EF <sub>HRPDCAP</sub>	6F56–TR	PIN–ADM	ADM-ADM	2–O	Specified by Operator
EF <sub>HRPDUUP</sub>	6F57–TR	PIN–ADM	ADM-ADM	Variable–O	Specified by Operator
HRPD AA CHAP SS	---	Never–Never	-	Variable–O	Specified by Operator
EF <sub>CSSPR</sub>	6F58–TR	PIN–ADM	ADM-ADM	1–O	D = 'FF'
EF <sub>ATC</sub>	6F59–TR	PIN–ADM	ADM-ADM	1–O	Specified by Operator
EF <sub>EPRL</sub>	6F5A–TR	PIN–ADM	ADM-ADM	Variable–O	Specified by Operator
EF <sub>BCSMScfg</sub>	6F5B–TR	PIN–ADM	ADM-ADM	1–O	Specified by Operator
EF <sub>BCSMSpref</sub>	6F5C–TR	PIN–PIN	ADM-ADM	1–O	D = 'FF'
EF <sub>BCSMSstable</sub>	6F5D–LF	PIN–ADM	ADM-ADM	Variable–O	D = '00 FF...FF'
EF <sub>BCSMSp</sub>	6F5E–LF	PIN–PIN	ADM-ADM	2–O	D = 'FF FF'
EF <sub>BAKPARA</sub>	6F63–LF	PIN–ADM	ADM-ADM	Variable–O	Specified by Operator
EF <sub>UpBAKPARA</sub>	6F64–CY	PIN–ADM	ADM-ADM	Variable–O	Specified by Operator
EF <sub>MMSN</sub>	6F65–LF	PIN–PIN	ADM-ADM	Variable–O	D='00 00 00 FF...FF'
EF <sub>EXT8</sub>	6F66–LF	PIN–PIN	ADM-ADM	Variable–O	D='FF...FF'
EF <sub>MMSICP</sub>	6F67–TR	PIN–ADM	ADM-ADM	Variable–O	D='FF...FF'
EF <sub>MMSUP</sub>	6F68–LF	PIN–PIN	ADM-ADM	Variable–O	D='FF...FF'
EF <sub>MMSUCP</sub>	6F69–TR	PIN– PIN/PIN2	ADM-ADM	Variable–O	D= 'FF...FF'
EF <sub>AuthCapability</sub>	6F6A–LF	PIN–ADM	ADM-ADM	Variable–O	D= '00...00'
EF <sub>3GCIK</sub>	6F6B–TR	PIN–ADM	ADM-ADM	32–O	Specified by Operator
EF <sub>DCK</sub>	6F6C–TR	PIN–PIN	ADM-ADM	20–O	Specified by Operator
EF <sub>GID1</sub>	6F6D–TR	PIN–ADM	ADM-ADM	N–O	Specified by Operator

File Name	File ID – File Type	Access Read – Update	Access – Invalidate-Rehabilitate	Size – M/O	Default Values (D) and/or Parameter Values (P) in Bytes
EF <sub>GID2</sub>	6F6E–TR	PIN–ADM	ADM-ADM	N–O	Specified by Operator
EF <sub>CDMACNL</sub>	6F6F–TR	PIN–ADM	ADM-ADM	7N–O	Specified by Operator
EF <sub>HOME_TAG</sub>	6F70–TR	PIN–ADM	ADM-ADM	N–M	Specified by Operator
EF <sub>GROUP_TAG</sub>	6F71–TR	PIN–ADM	ADM-ADM	Variable–M	Specified by Operator
EF <sub>SPECIFIC_TAG</sub>	6F72–TR	PIN–ADM	ADM-ADM	Variable–M	Specified by Operator
EF <sub>CALL_PROMPT</sub>	6F73–TR	PIN–ADM	ADM-ADM	Variable–M	Specified by Operator
EF <sub>SF_EUIMID</sub>	6F74–TR	ALW–Never	Never-Never	7–O	Specified by CSIM Manufacturer
EF <sub>EST</sub>	6F75–TR	PIN–PIN	ADM-ADM	Variable–O	Specified by Operator
EF <sub>HiddenKey</sub>	6F76–TR	PIN–ADM	ADM-ADM	–O	Specified by Operator
EF <sub>LCSVER</sub>	6F77–TR	PIN–ADM	ADM-ADM	Variable–O	Specified by Operator
EF <sub>LCS SCP</sub>	6F78–TR	PIN–ADM	ADM-ADM	Variable–O	Specified by Operator
EF <sub>SDN</sub>	6F79–LF	PIN–PIN2	ADM-ADM	Variable–O	Specified by Operator
EF <sub>EXT2</sub>	6F7A–LF	PIN–ADM	ADM-ADM	13–O	Specified by Operator
EF <sub>EXT3</sub>	6F7B–LF	PIN–PIN	ADM-ADM	13–O	Specified by Operator
EF <sub>ICI</sub>	6F7C–CY	PIN–PIN	ADM-ADM	Variable–O	Specified by Operator
EF <sub>OCI</sub>	6F7D–CY	PIN–PIN	ADM-ADM	Variable–O	Specified by Operator
EF <sub>EXT5</sub>	6F7E–LF	PIN–PIN	ADM-ADM	13–O	Specified by Operator
EF <sub>CCP2</sub>	6F7F–LF	PIN–PIN	ADM-ADM	Variable–O	D='FF...FF'
EF <sub>AppLabels</sub>	6F80–TR	PIN–ADM	ADM-ADM	Variable–O	Specified by Operator
EF <sub>Model</sub>	6F81–TR	PIN–PIN	ADM-ADM	126–O	D='FF...FF'
EF <sub>RC</sub>	6F82–TR	ALW–ADM	ADM-ADM	Variable–O	Specified by Operator
EF <sub>SMSCAP</sub>	6F83–TR	PIN–ADM	ADM-ADM	4–O	Specified by Operator
EF <sub>MIPFlags</sub>	6F84–TR	PIN–ADM	ADM-ADM	1–O	Specified by Operator
EF <sub>3GPDUPPExt</sub>	6F85–TR	PIN–ADM	ADM-ADM	Variable–O	Specified by Operator
Reserved	6F86–TR	n/a	n/a	n/a	n/a
EF <sub>IPV6CAP</sub>	6F87–TR	PIN–ADM	ADM-ADM	21–O	Specified by Operator
EF <sub>TCPConfig</sub>	6F88–TR	PIN–ADM	ADM-ADM	2–O	Specified by Operator
EF <sub>DGC</sub>	6F89–TR	PIN–ADM	ADM-ADM	3–O	Specified by Operator
EF <sub>WAPBrowserCP</sub>	6F8A–TR	PIN–ADM	ADM-ADM	Variable–O	Specified by Operator
EF <sub>WAPBrowserBM</sub>	6F8B–TR	PIN–PIN	ADM-ADM	Variable–O	D='FF...FF'

<b>File Name</b>	<b>File ID – File Type</b>	<b>Access Read – Update</b>	<b>Access – Invalidate- Rehabilitate</b>	<b>Size – M/O</b>	<b>Default Values (D) and/or Parameter Values (P) in Bytes</b>
EF <sub>MMSCConfig</sub>	6F8C–TR	PIN–ADM	ADM-ADM	8–O	Specified by Operator
EF <sub>JDL</sub>	6F8D–TR	PIN–ADM	ADM-ADM	Variable–O	Specified by Operator

## 1 **ANNEX F (NORMATIVE): RESERVATION OF FILE IDENTIFIERS**

2 The following FIDs are reserved by the present document:

- 3 • ADF:
  - 4 ○ Operational use (implicit FID for the current ADF):
    - 5 – '7FFF'.
- 6 • Dedicated Files:
  - 7 ○ Administrative use:
    - 8 – '7F4X', '5F1X', '5F2X'.
  - 9 ○ Operational use:
    - 10 – '7F10' (DF<sub>TELECOM</sub>), '7F20' (DF<sub>GSM</sub>), '7F21' (DF<sub>DCS1800</sub>), '7F22' (DF<sub>FIS-41</sub>), '7F23' (DF<sub>FP-CTS</sub>).
    - 11 – Reserved under '7F10' (DF<sub>TELECOM</sub>):
      - 12 ○ '5F50' (DF<sub>GRAPHICS</sub>); '5F3A' (DF<sub>PHONEBOOK</sub>); '5F3B' (DF<sub>MULTIMEDIA</sub>);
      - 13 '5F3C' (DF<sub>MMSS</sub>).
    - 14 – '7F24' (DF<sub>TIA/EIA-136</sub>), '7F25' (DF<sub>TIA/EIA-95</sub>) and '7F2X', where X ranges from '6' to 'F'.
    - 15 – '7F80' (DF<sub>PDC</sub>) is used for the Japanese PDC specification.
    - 16 – '7F90' (DF<sub>TETRA</sub>) is used for the TETRA specification.
    - 17 – '7F31' (DF<sub>IDEN</sub>) is used in the iDEN specification.
- 18 • Elementary files:
  - 19 ○ Administrative use:
    - 20 – '6F XX' in the DFs '7F 4X'; '4F XX' in the DFs '5F 1X', '5F2X'.
    - 21 – '6F 1X' in the DFs '7F 10', '7F 20', '7F 21';
    - 22 – '4F 1X' in all 2nd level DFs;
    - 23 – '2F EX' in the MF '3F 00'.
  - 24 ○ Operational use:
    - 25 – '6F 2X', '6F 3X', '6F 4X' in '7F 10' and '7F 2X';
    - 26 – '4F YX', where Y ranges from '2' to 'F' in all 2nd level DFs;
    - 27 – '2F05', '2F06' and '2F 1X' in the MF '3F 00'.
  - 28 ○ Operational use [53]:
    - 29 – '2F00' EF<sub>DIR</sub>, '2F01' EF<sub>ATR</sub> in the MF '3F00'.
  - 30 ○ Reserved under CDMA ADF:
    - 31 – '6F86': Reserved
    - 32 – From '6F8E' to '6F96' (reserved for CDG)

33 In all the above, X ranges, unless otherwise stated, from '0' to 'F'.